

**AVAILABLE COLORS:**

108 BLACK	270 GREIGE
136 GRAY	232 WHITE

CUSTOM COLORS ARE AVAILABLE AT AN ADDITIONAL CHARGE, SUBJECT TO MINIMUM QUANTITIES.

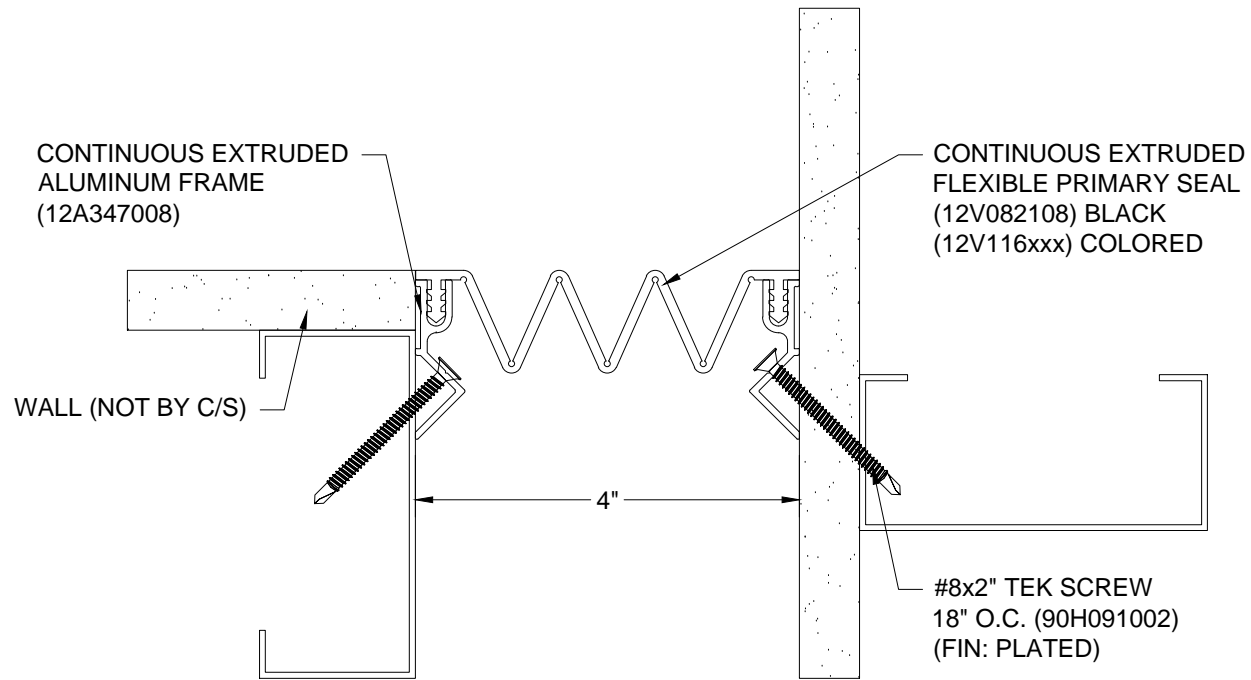

# Model: FWSC-400M



**Construction Specialties**  
www.c-sgroup.com

6696 Route 405 Highway, Muncy, PA 17756  
Phone: (800) 233-8493 / Fax: (570) 546-8022

895 Lakefront Promenade, Mississauga, Ontario L5E 2C2 Canada  
Phone: (888) 895-8955 / Fax: (905) 274-6241



**DISCLAIMER:**

This document is the property of Construction Specialties, Inc. and contains confidential proprietary information that is not to be disclosed to third parties and is not to be used without approval in writing from Construction Specialties, Inc.

<b>PROJECT:</b>	<b>SCALE:</b> 1:2
<b>CUSTOMER:</b>	<b>DATE:</b>
<b>LOCATION:</b>	<b>JOB NO.:</b>
<b>DRAWN BY:</b>	<b>SHEET NO.:</b>