

COLOR:
 CORNER GUARD:
 COLOR TO BE SELECTED FROM ONE OF CS STANDARD COLORS.

UNITS REQ'D	CEILING HEIGHT	RETAINER LENGTH	COVER LENGTH	BASE HEIGHT

- NOTES:**
- UNITS TO BE FURNISHED IN LENGTHS TO ACCOMMODATE THE SPECIFIED CEILING HEIGHT, WITH 2" ADDED FOR FIELD VARIATIONS. WHERE POSSIBLE, THIS 2" SHOULD EXTEND INTO THE CEILING.
 - A MINIMUM 24 GA. CHANNEL STUD MUST BE SECURELY ANCHORED TOP AND BOTTOM TO INSURE POSITIVE ATTACHMENT OF ALUMINUM RETAINERS. IF TRUSS STUDS ARE USED, CHANNEL STUDS MUST BE USED AT CORNER.

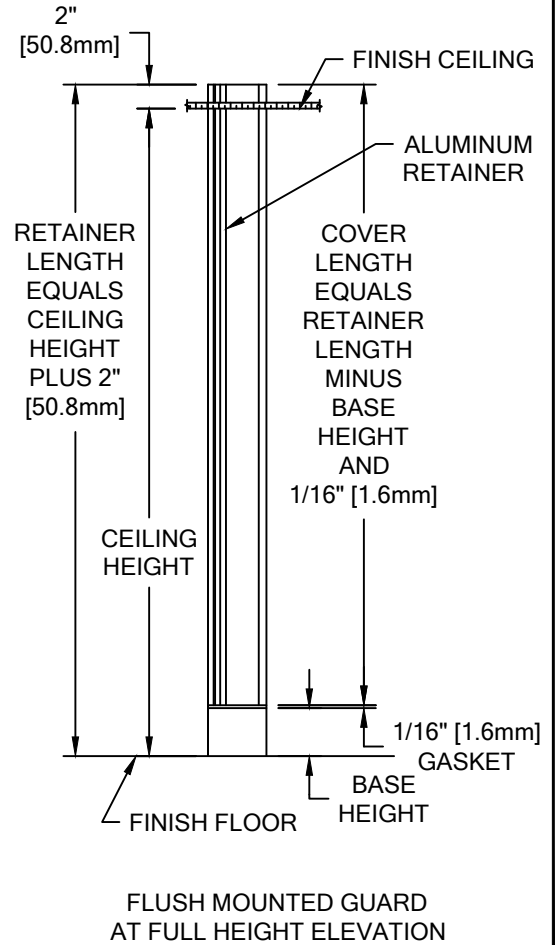
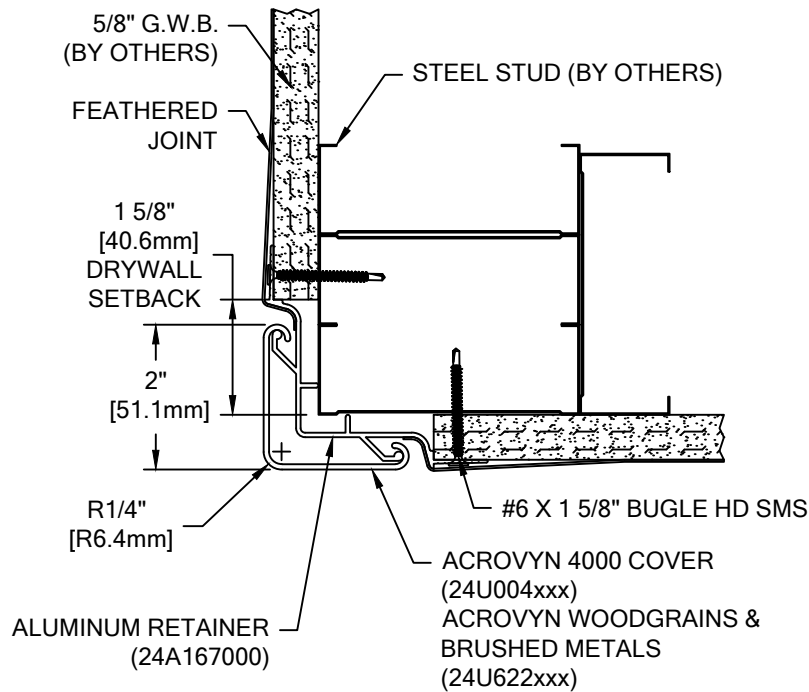

SFS-20N ACROVYN 4000

WALL CONDITION	SPECIFIED FASTENER	DRILL DIAMETERS		CS PART NUMBER
		WALL	RETAINER	
STEEL STUD/GYPSUM WALL WOOD STUD/GYPSUM WALL	#6 X 1 5/8" BUGLE HEAD SMS	N/A	N/A	90H079002

 Hughesville, PA 800.233.8493 570.546.5941 Mississauga, ON 888.895.8955 905.274.3611 www.c-sgroup.com © Copyright 2016 Construction Specialties, Inc.	PROJECT:	REVISION:
	JOB NO.:	F&F:
	CUSTOMER:	
	REP:	DATE:
	DRAWN BY:	SHEET NO: