

3/16"x1 3/4" TAPPER 18" O.C.
(90H236004) (FIN: SILVER P/S)
ICC-ES#-ESR-3068 (MASONRY)

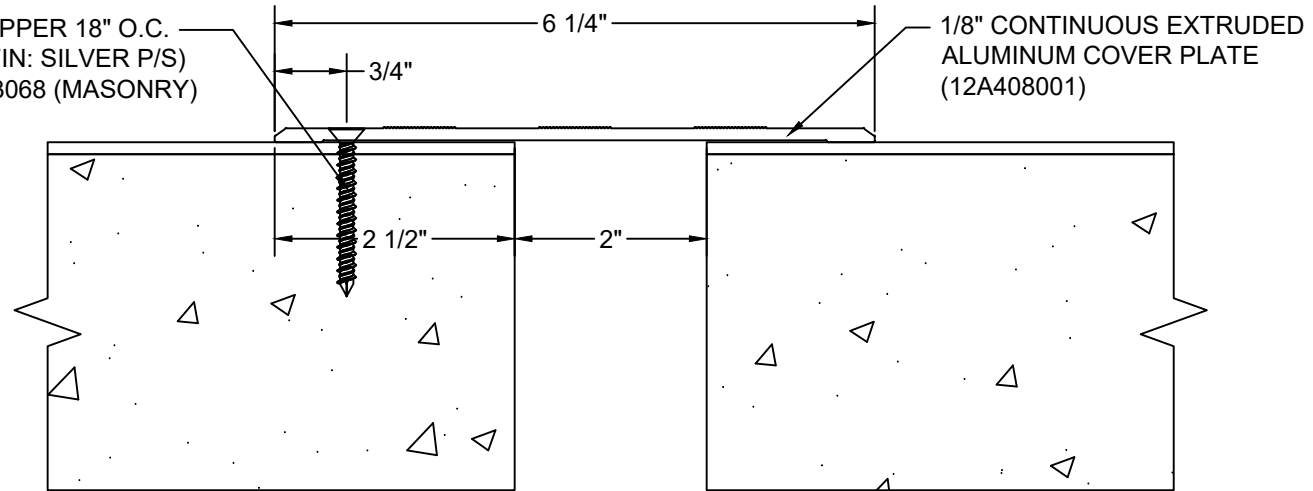

1/8" CONTINUOUS EXTRUDED
ALUMINUM COVER PLATE
(12A408001)

Model: PCS2G-200



Construction Specialties®

www.c-sgroup.com

6696 Route 405 Highway, Muncy, PA 17756
Phone: (800) 233-8493 / Fax: (570) 546-8022

895 Lakefront Promenade, Mississauga, Ontario L5E 2C2 Canada
Phone: (888) 895-8955 / Fax: (905) 274-6241

© Copyright 2018 Construction Specialties, Inc.

PROJECT:	SCALE: NTS
CUSTOMER:	DATE:
LOCATION:	JOB NO.:
DRAWN BY:	SHEET NO.: