

108 BLACK 232 WHITE **AVAILABLE COLORS:** 270 GREIGE 136 GRAY

*** CUSTOM COLORS ARE AVAILABLE AT AN ADDITIONAL CHARGE, SUBJECT TO MINIMUM QUANTITIES. ***

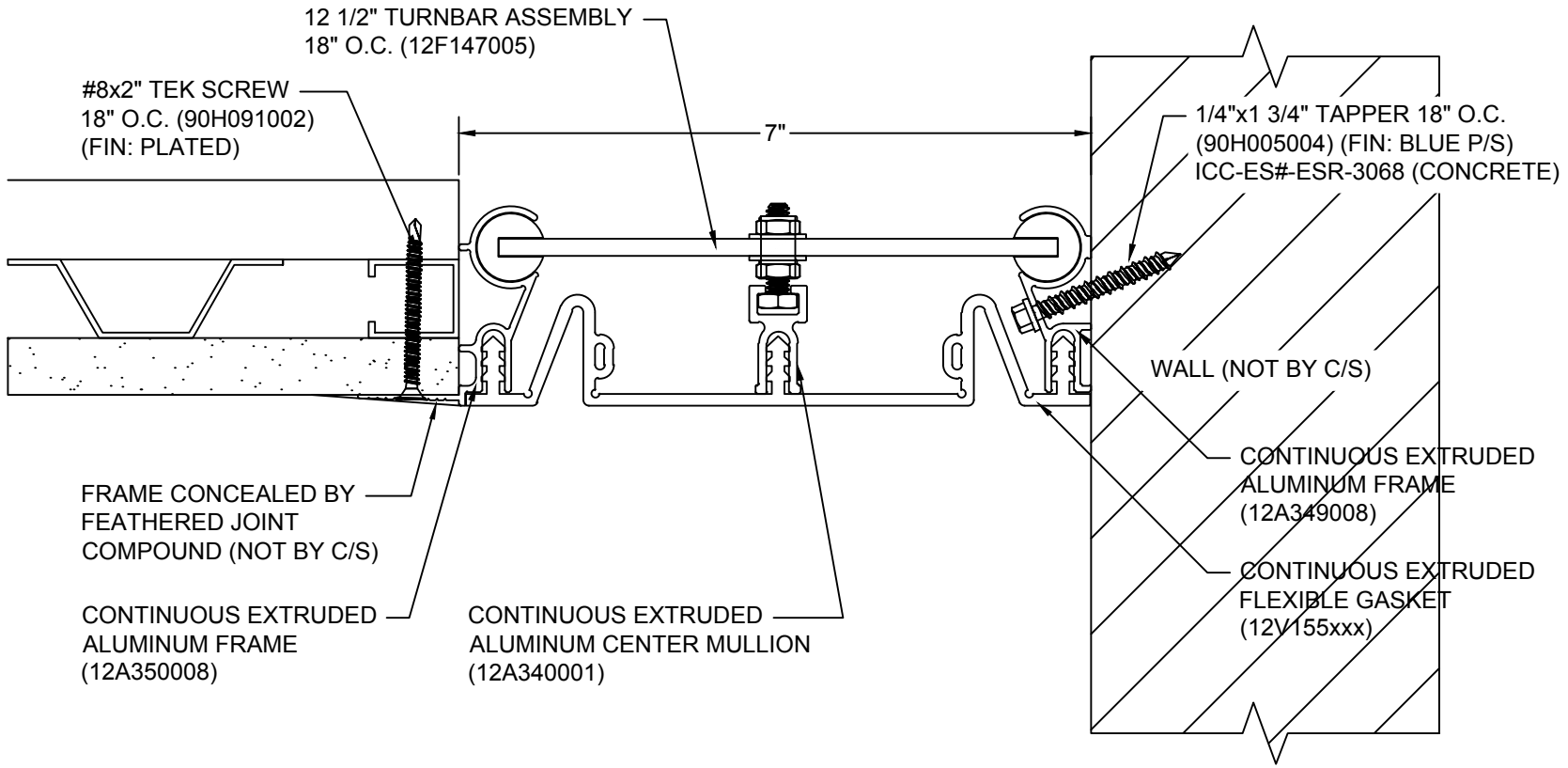

Model: FWFC-700

CS™ **Construction Specialties**
www.c-sgroup.com

6696 Route 405 Highway, Muncy, PA 17756
Phone: (800) 233-8493 / Fax: (570) 546-8022

895 Lakefront Promenade, Mississauga, Ontario L5E 2C2 Canada
Phone: (888) 895-8955 / Fax: (905) 274-6241



DISCLAIMER:

This document is the property of Construction Specialties, Inc. and contains confidential proprietary information that is not to be disclosed to third parties and is not to be used without approval in writing from Construction Specialties, Inc.

| | |
|------------------|-------------------|
| PROJECT: | SCALE: 1:2 |
| CUSTOMER: | DATE: |
| LOCATION: | JOB NO.: |
| DRAWN BY: | SHEET NO.: |