

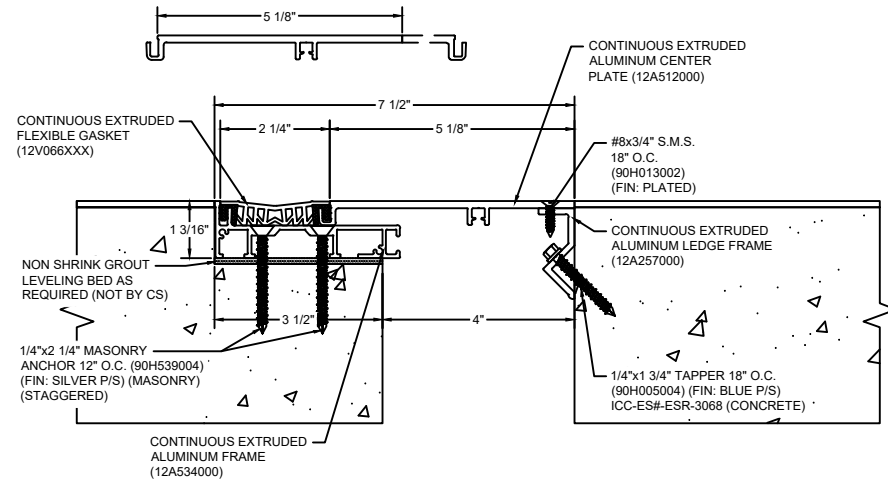

\*\*\* CUSTOM COLORS ARE AVAILABLE AT AN ADDITIONAL CHARGE, SUBJECT TO MINIMUM QUANTITIES. \*\*\*



# Model: DGTPM-400

**CS** **Construction Specialties®**  
[www.c-sgroup.com](http://www.c-sgroup.com)  
 6696 Route 405 Highway, Muncy, PA 17756  
 Phone: (800) 233-8493 / Fax: (570) 546-8022  
 895 Lakefront Promenade, Mississauga, Ontario L5E 2C2 Canada  
 Phone: (888) 895-8955 / Fax: (905) 274-6241

© Copyright 2018 Construction Specialties, Inc.

<b>PROJECT:</b>	<b>SCALE:</b> NTS
<b>CUSTOMER:</b>	<b>DATE:</b>
<b>LOCATION:</b>	<b>JOB NO.:</b>
<b>DRAWN BY:</b>	<b>SHEET NO.:</b>