

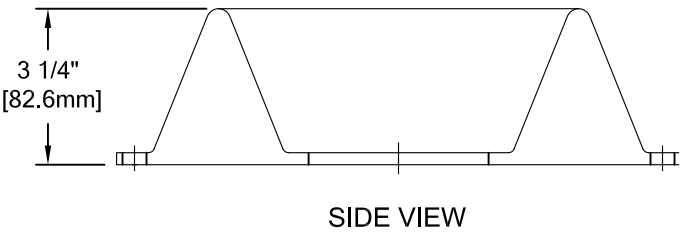

COLOR: _____
 DOOR KNOB PROTECTOR: _____
 COLOR TO BE SELECTED FROM ONE OF CS STANDARD COLORS.

DOOR # / MARK #	UNITS REQ'D

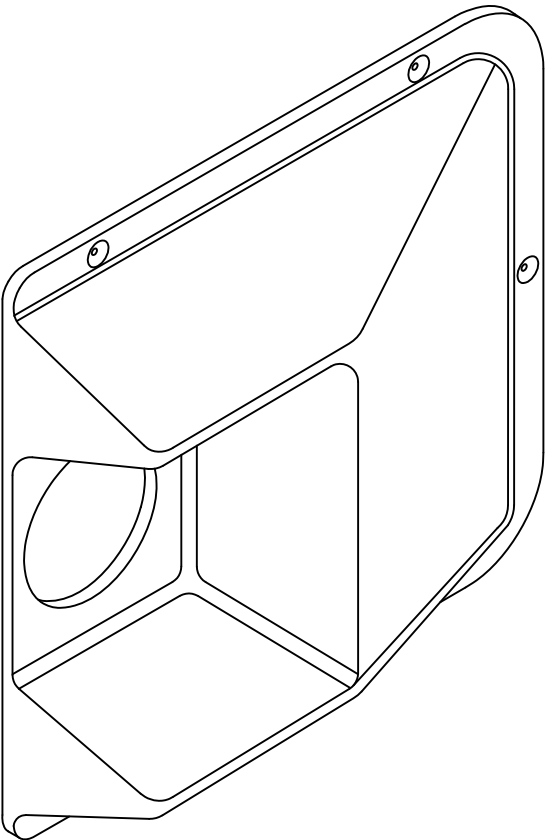
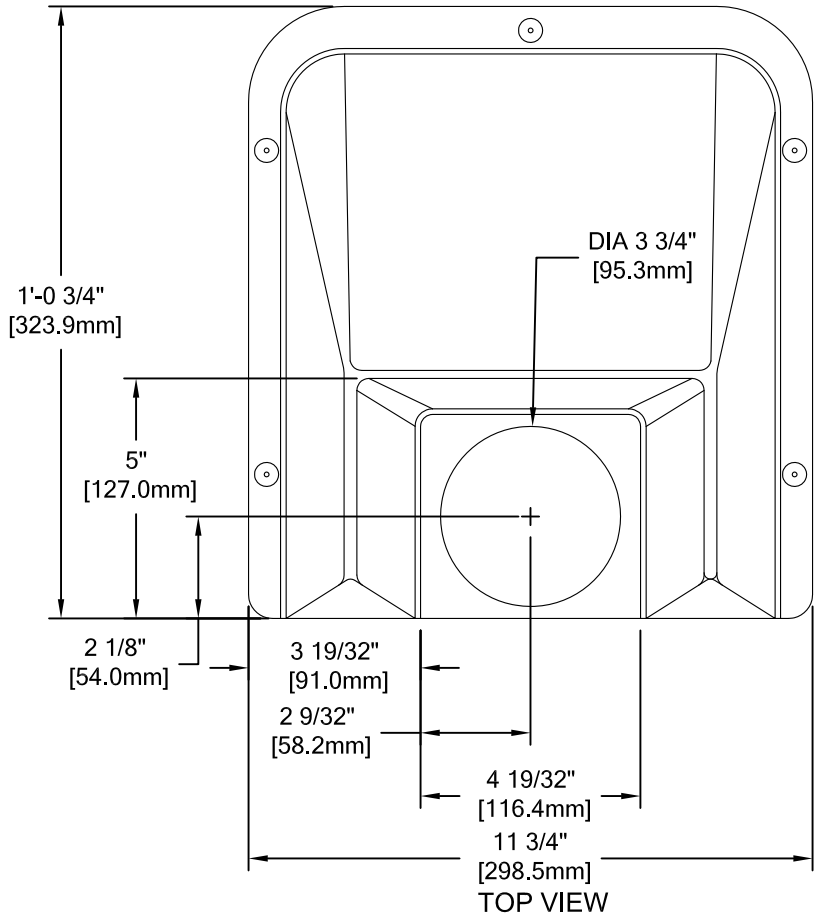

DNP-1 ACROVYN 4000

CONDITION	SPECIFIED FASTENER	DRILL DIAMETERS	CS PART NUMBER
		DOOR	
HOLLOW METAL WOOD	1-3/4" LONG ALUMINUM SCREW POST 1/2" LONG FLAT HEAD MACHINE SCREW (SLOTTED)	7/32"	90H016010

 Hughesville, PA 800.233.8493 570.546.5941 Mississauga, ON 888.895.8955 905.274.3611 www.c-sgroup.com © Copyright 2016 Construction Specialties, Inc.	PROJECT:	REVISION:
	JOB NO.:	F&F:
	CUSTOMER:	
	REP:	DATE:
	DRAWN BY:	SHEET NO: