

AP4 (No Added Mass) – Test A, 0.5in. Quasi-static X Disp

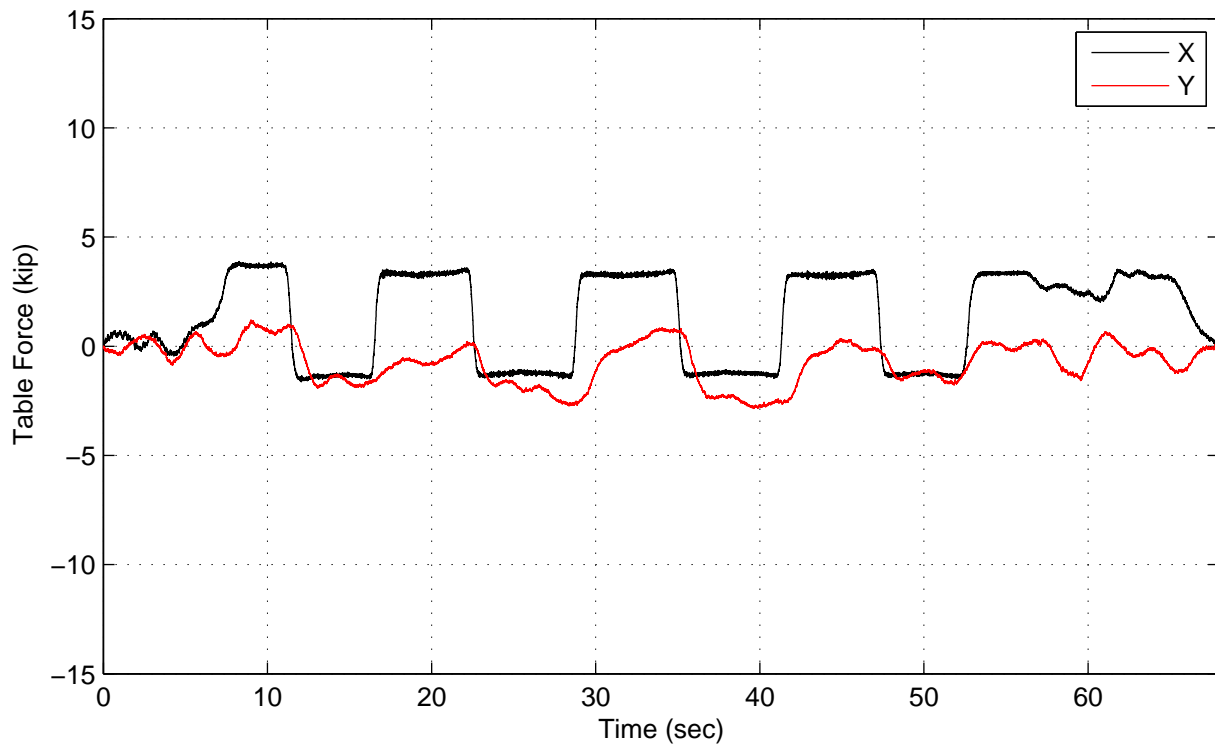

AP4 (No Added Mass) – Test A, 0.5in. Quasi-static X Disp

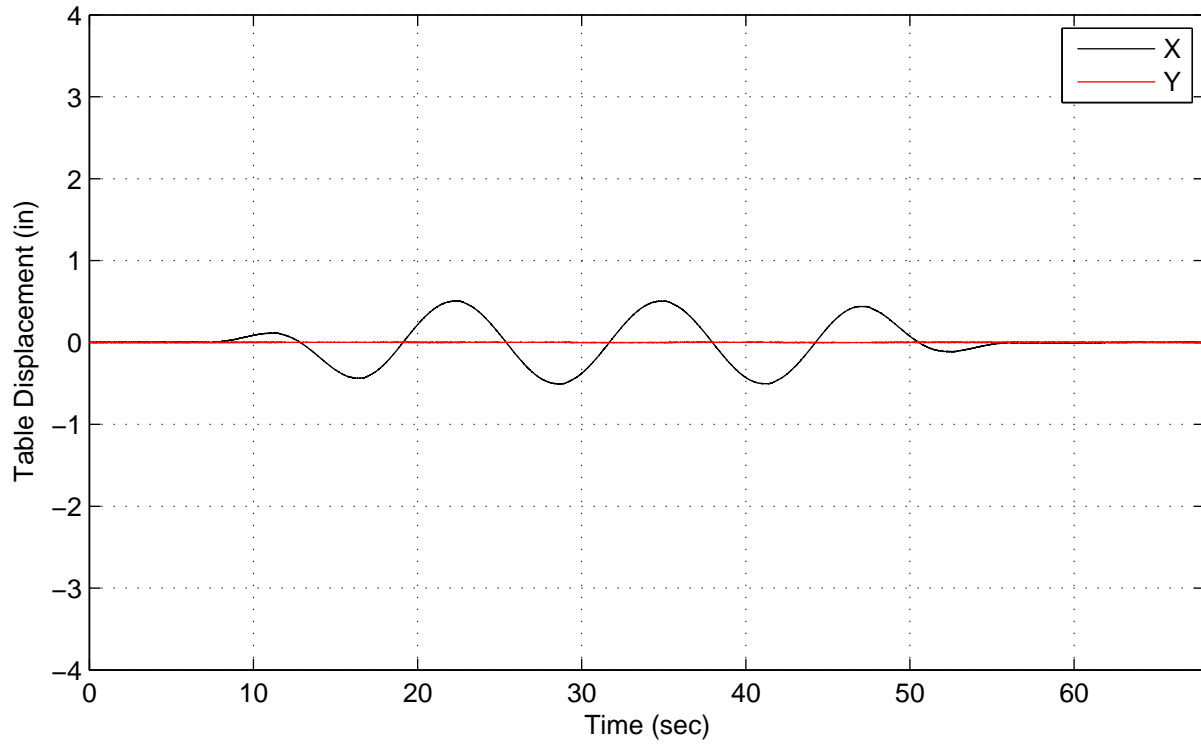
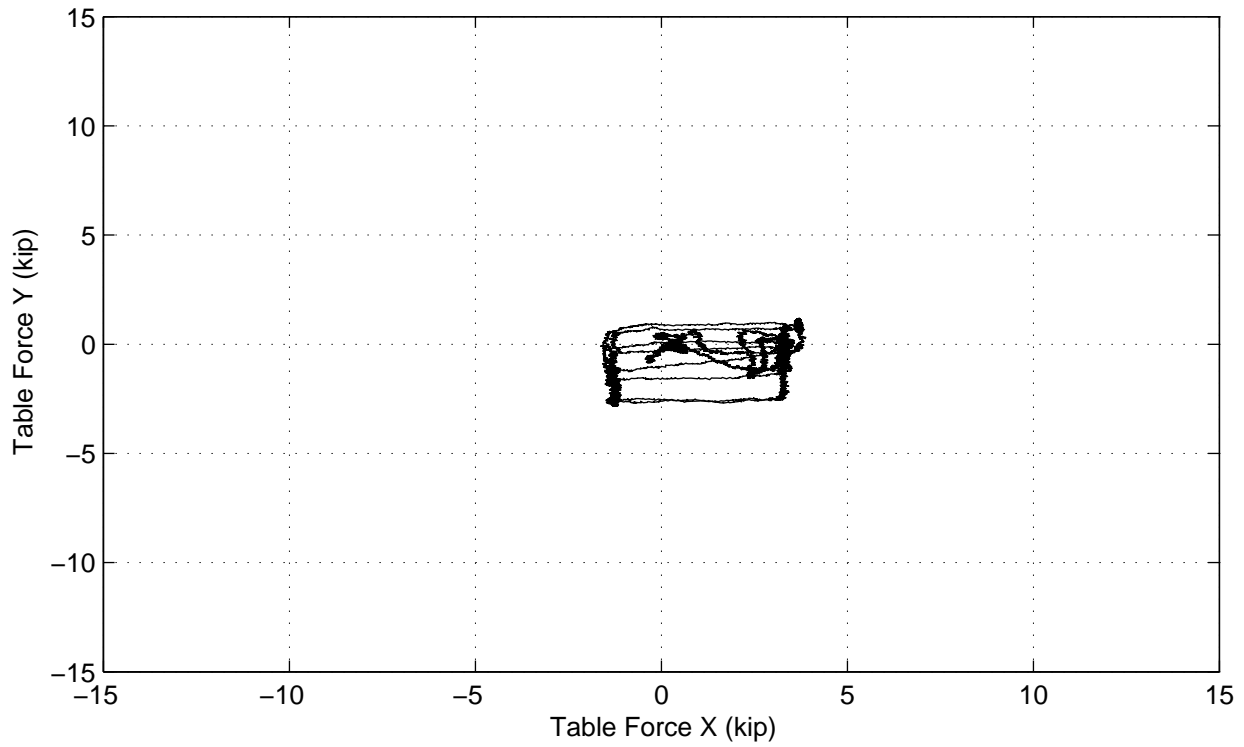
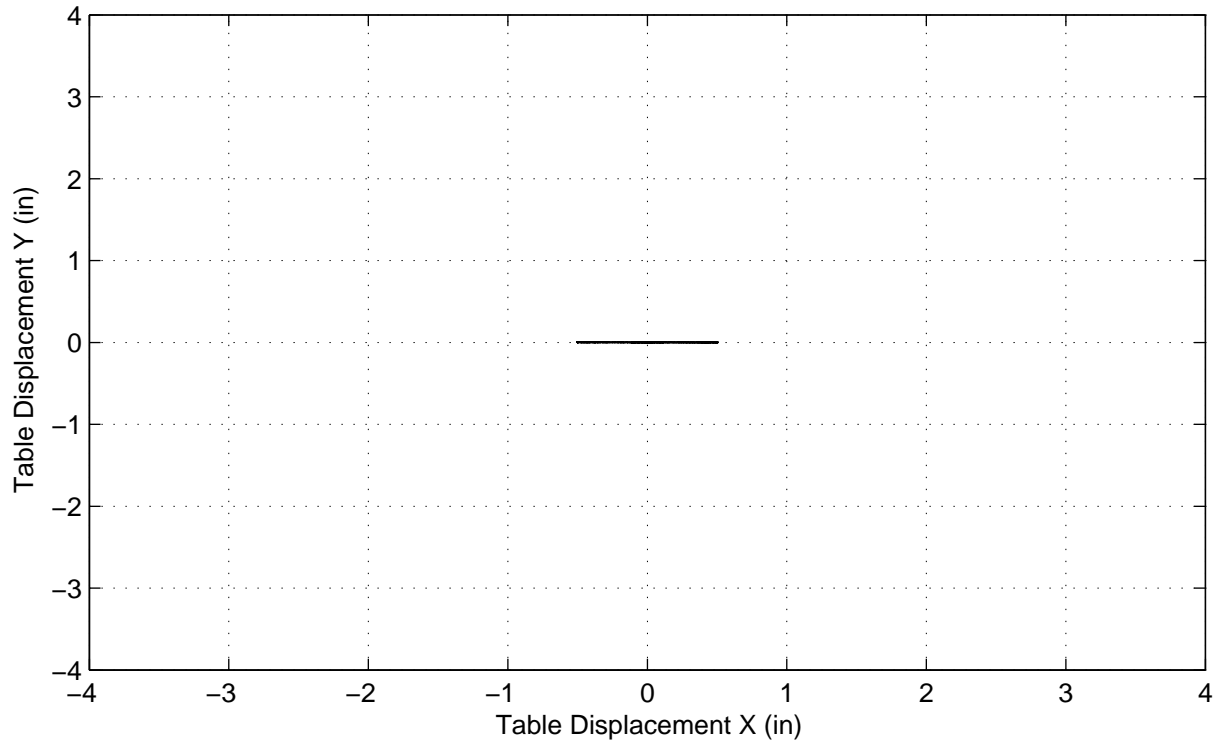

AP4 (No Added Mass) – Test A, 0.5in. Quasi-static X Disp

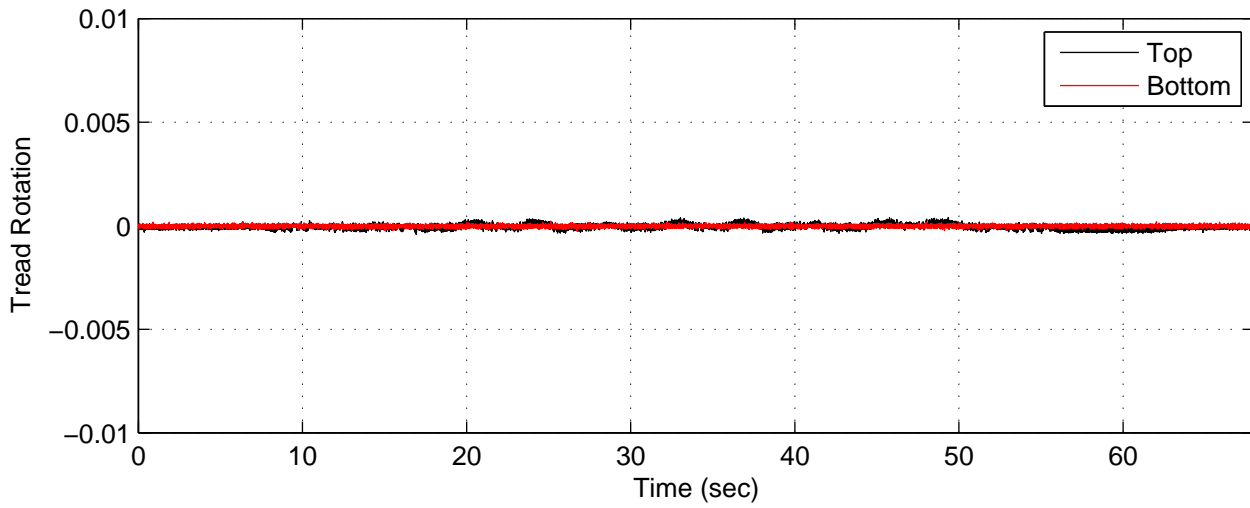
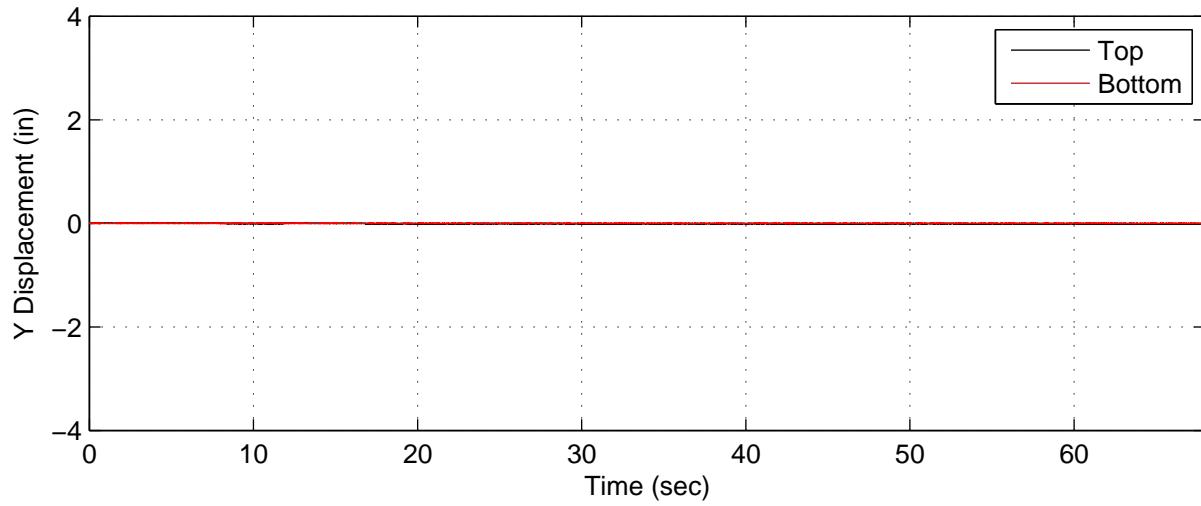
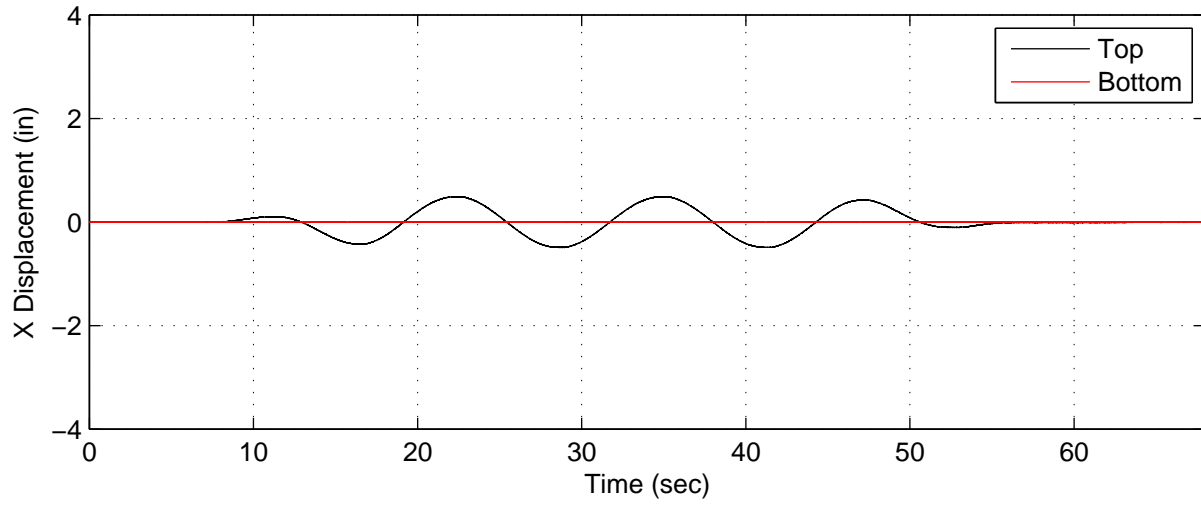

AP4 (No Added Mass) – Test A, 0.5in. Quasi-static X Disp

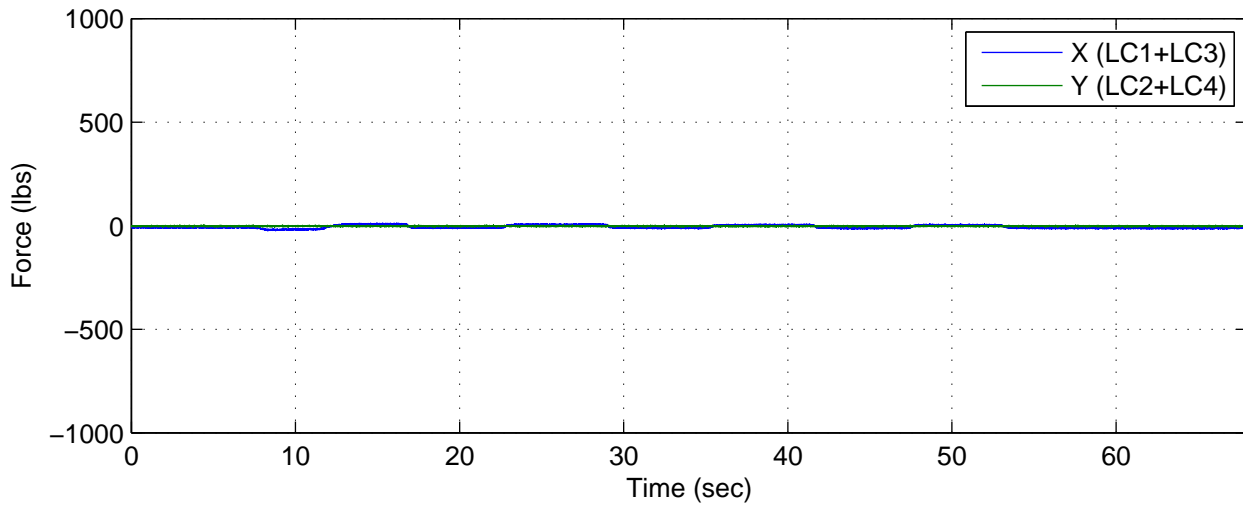
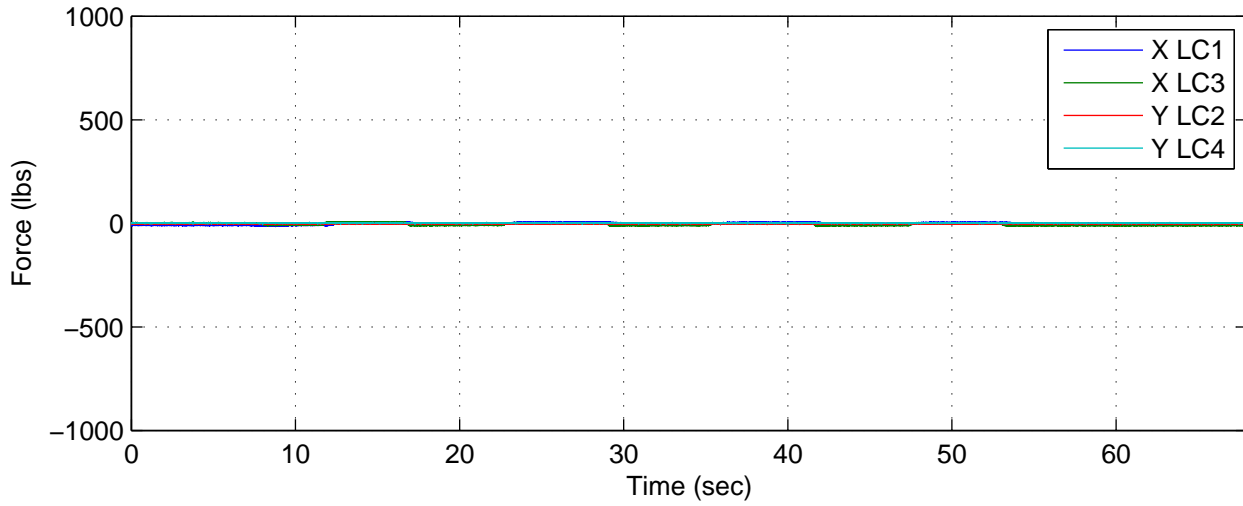
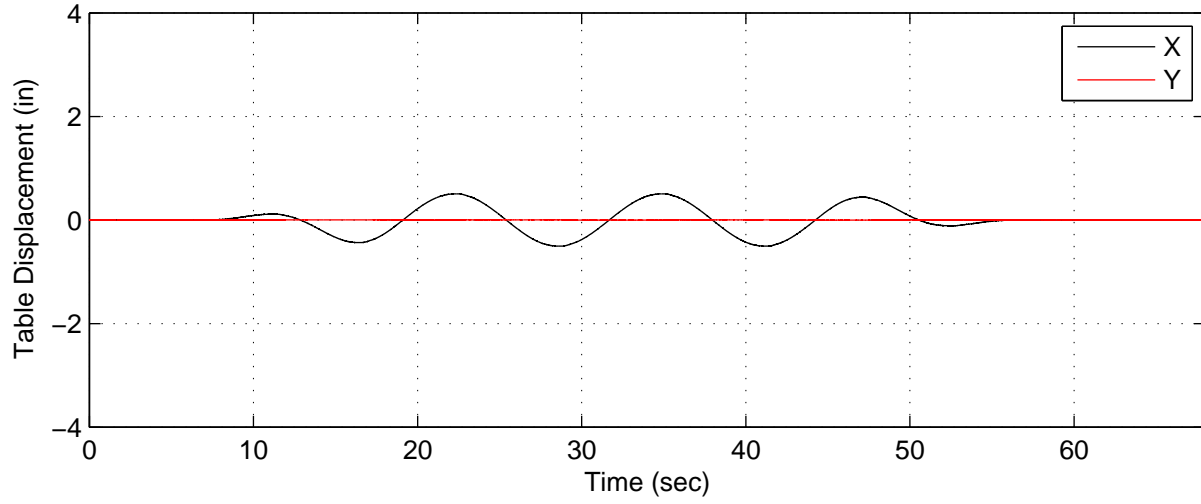

AP4 (No Added Mass) – Test A, 0.5in. Quasi-static X Disp

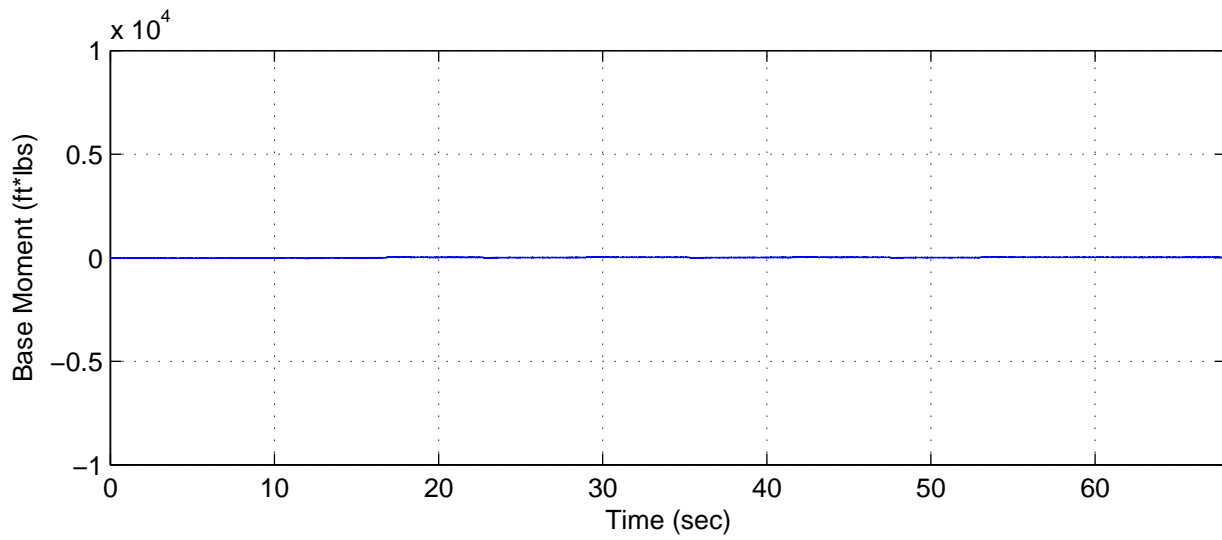
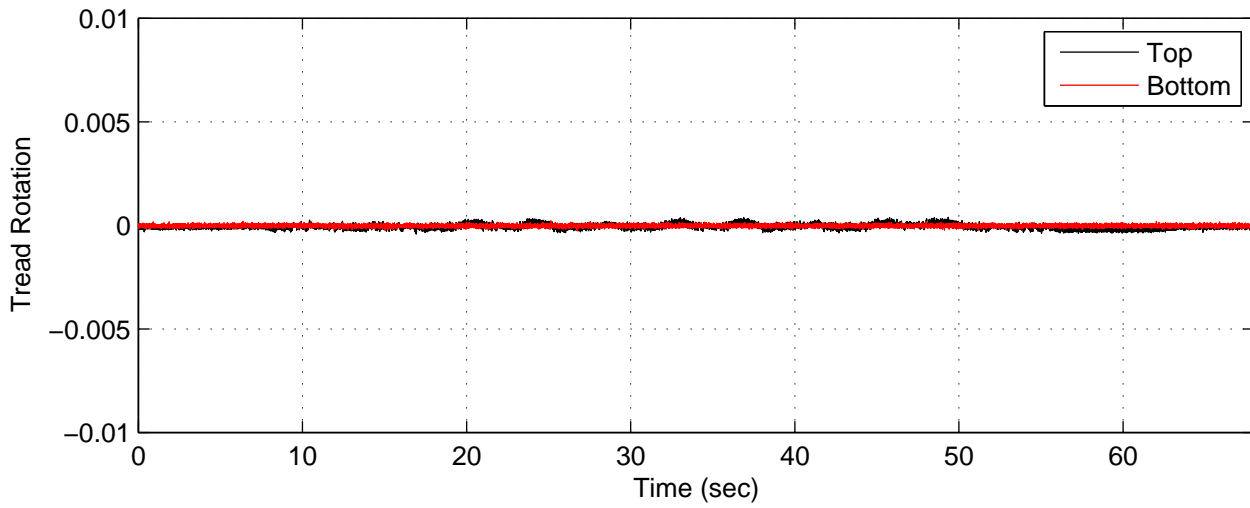
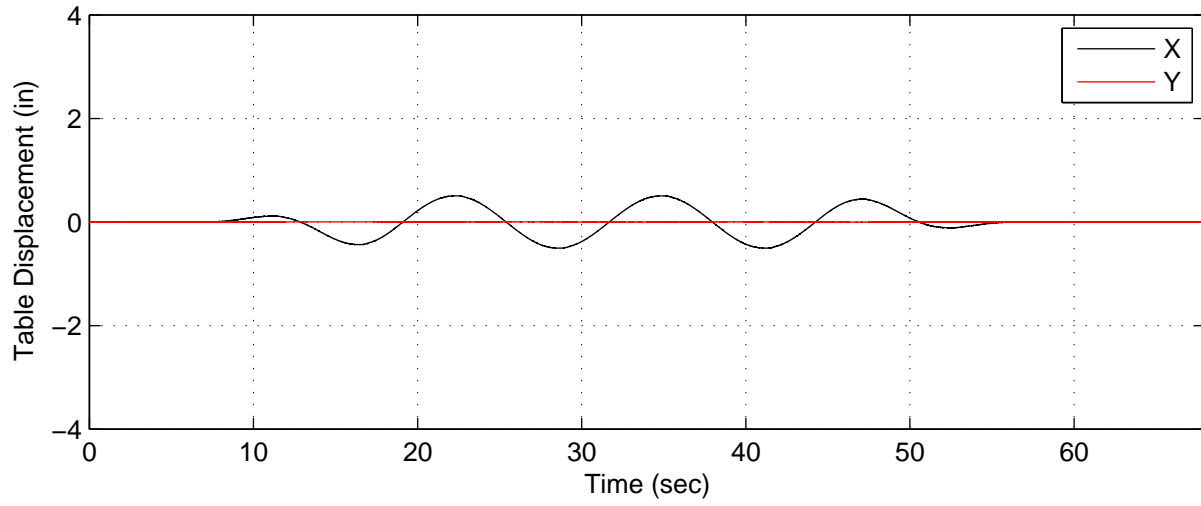

AP4 (No Added Mass) – Test B, 2.5in. Quasi-static X Disp

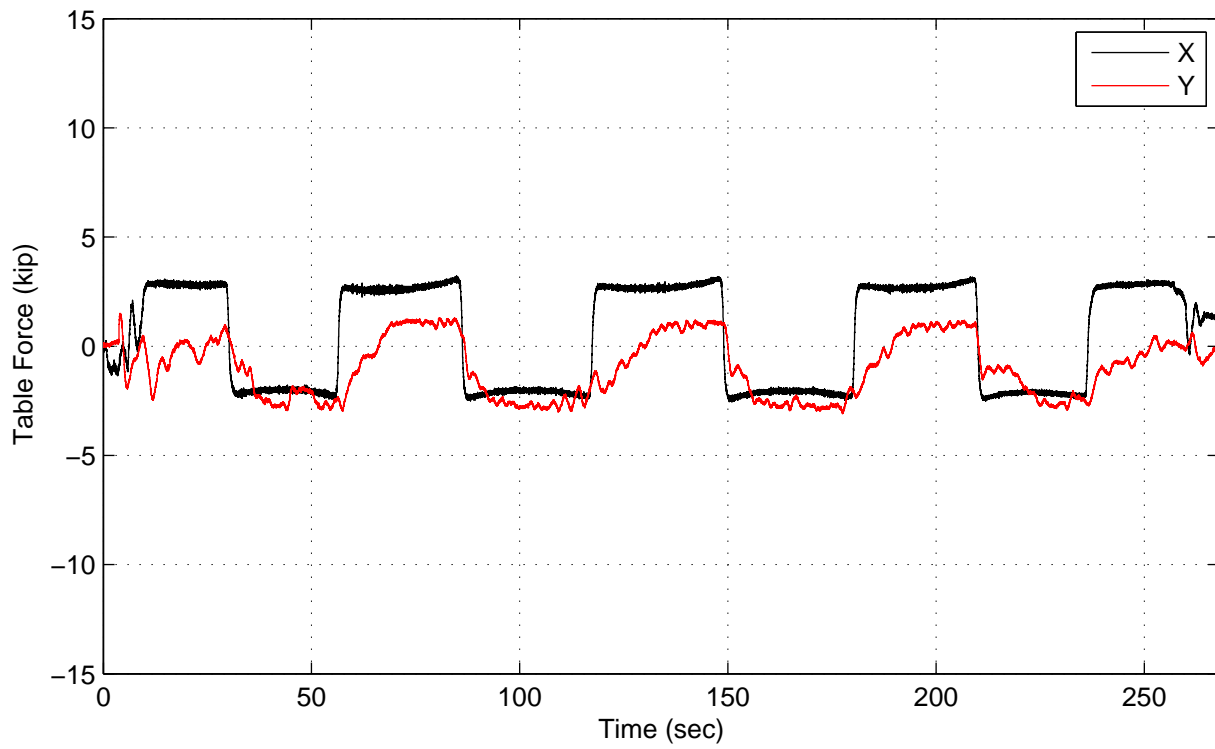
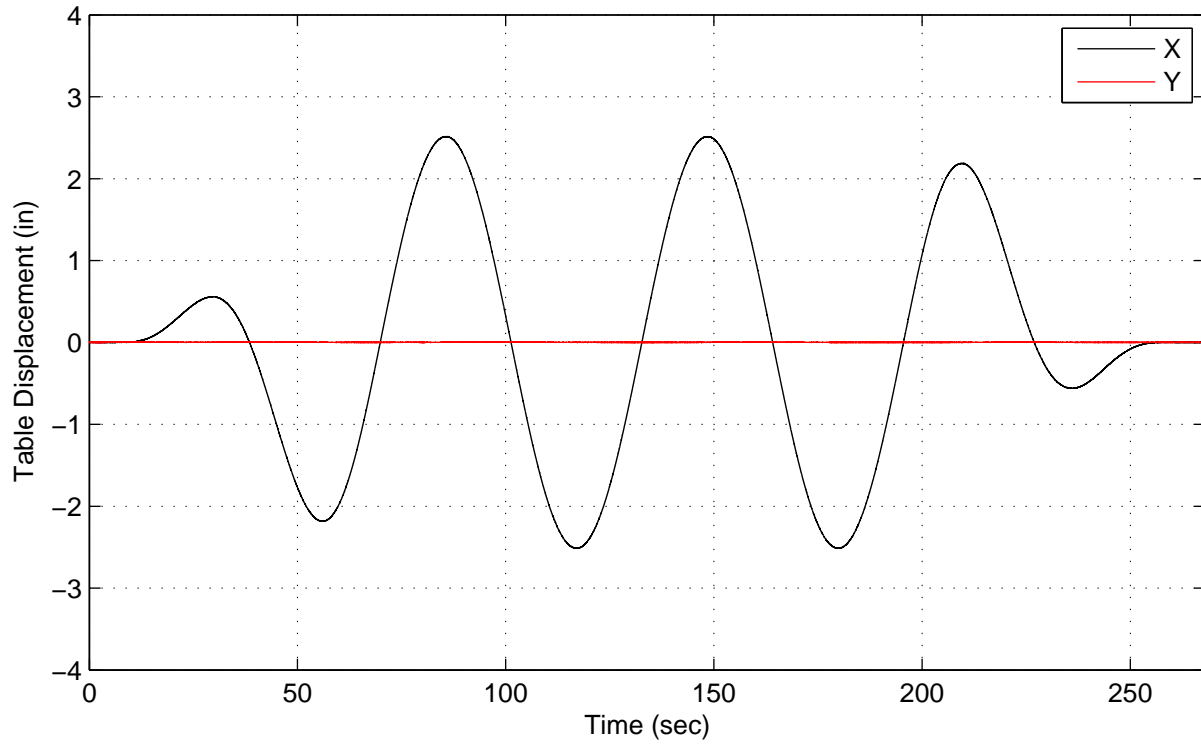

AP4 (No Added Mass) – Test B, 2.5in. Quasi-static X Disp

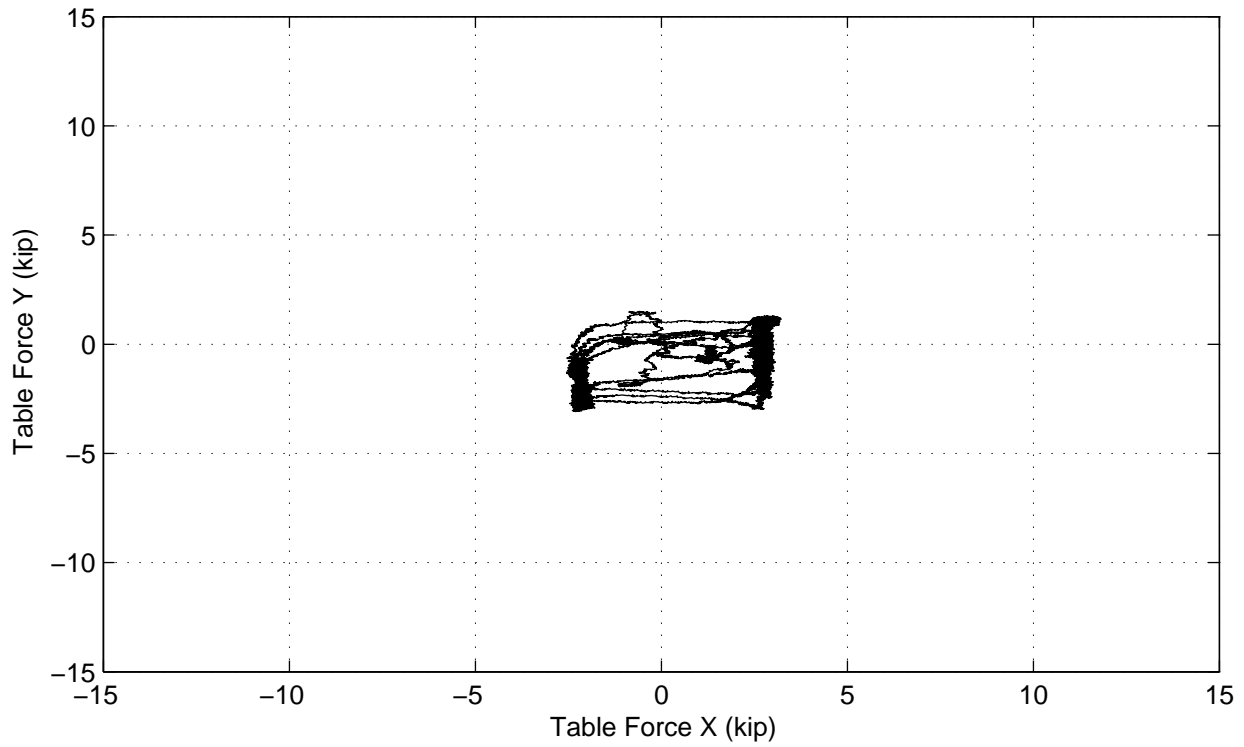
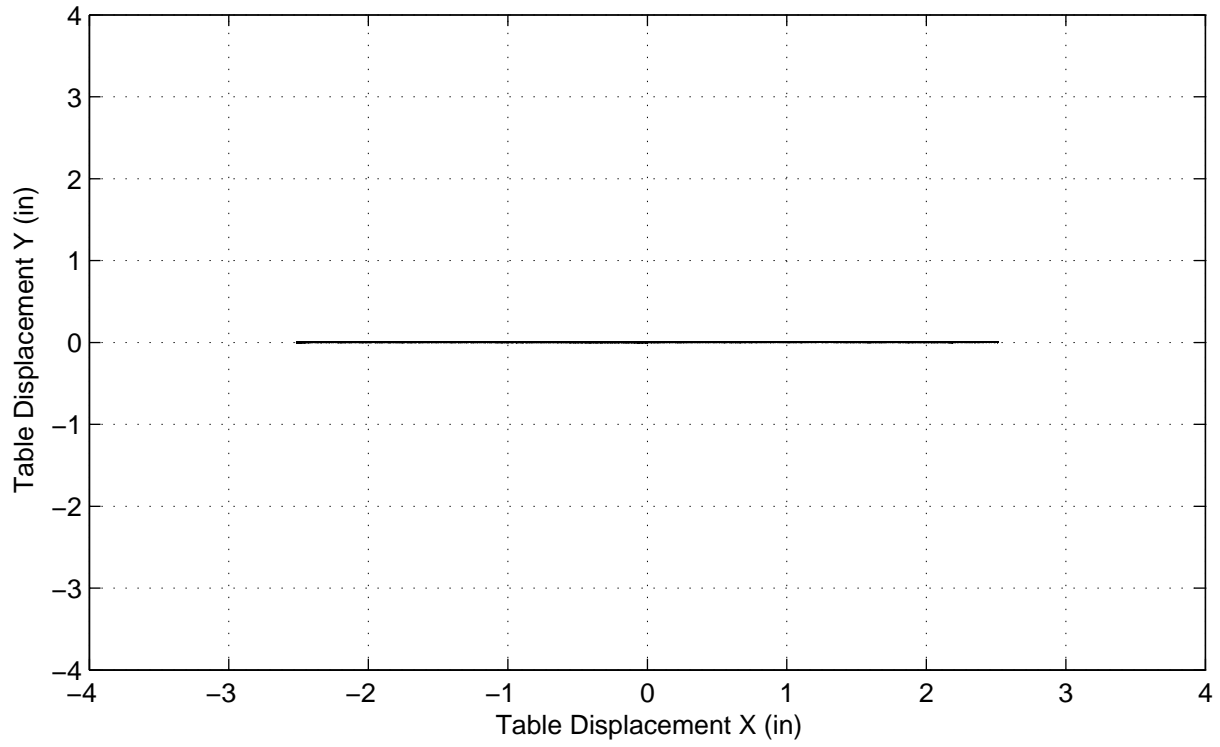

AP4 (No Added Mass) – Test B, 2.5in. Quasi-static X Disp

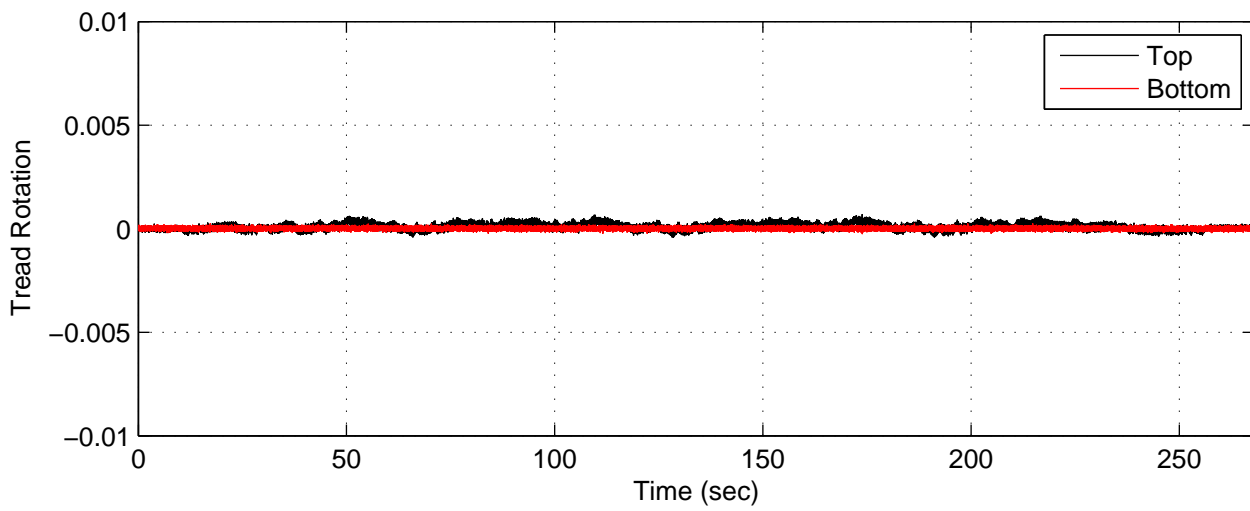
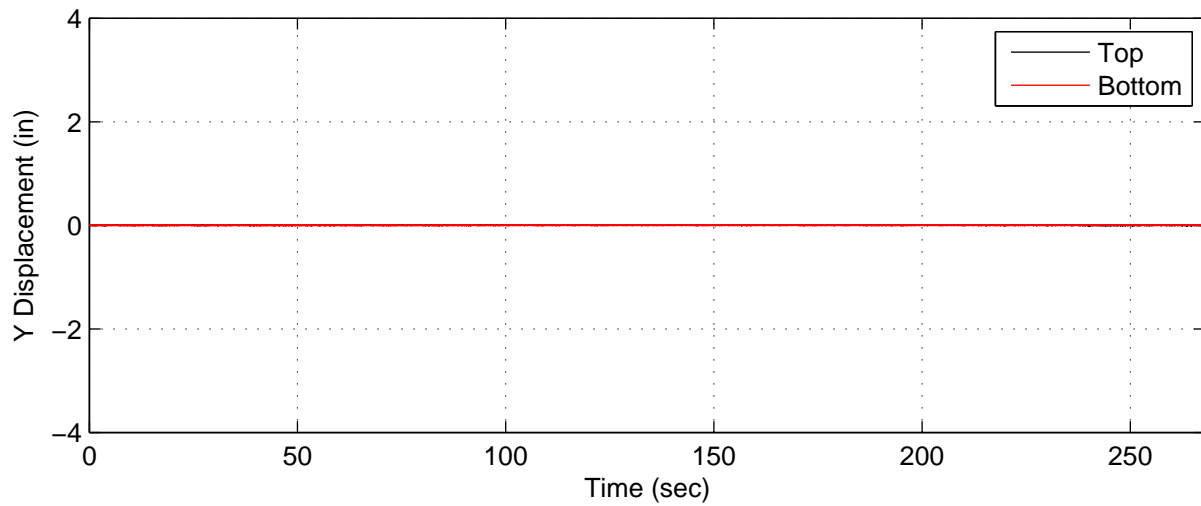
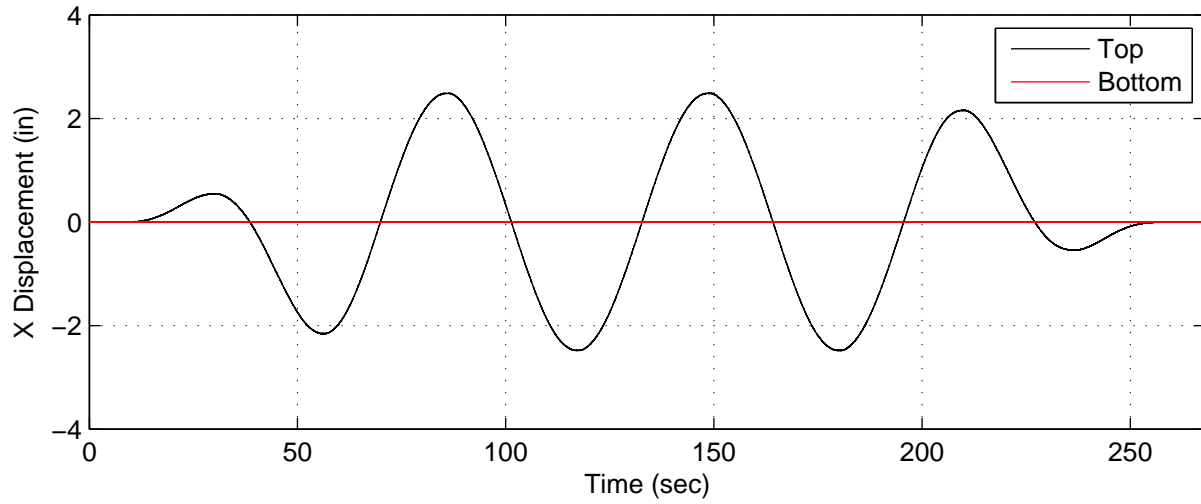



AP4 (No Added Mass) – Test B, 2.5in. Quasi-static X Disp

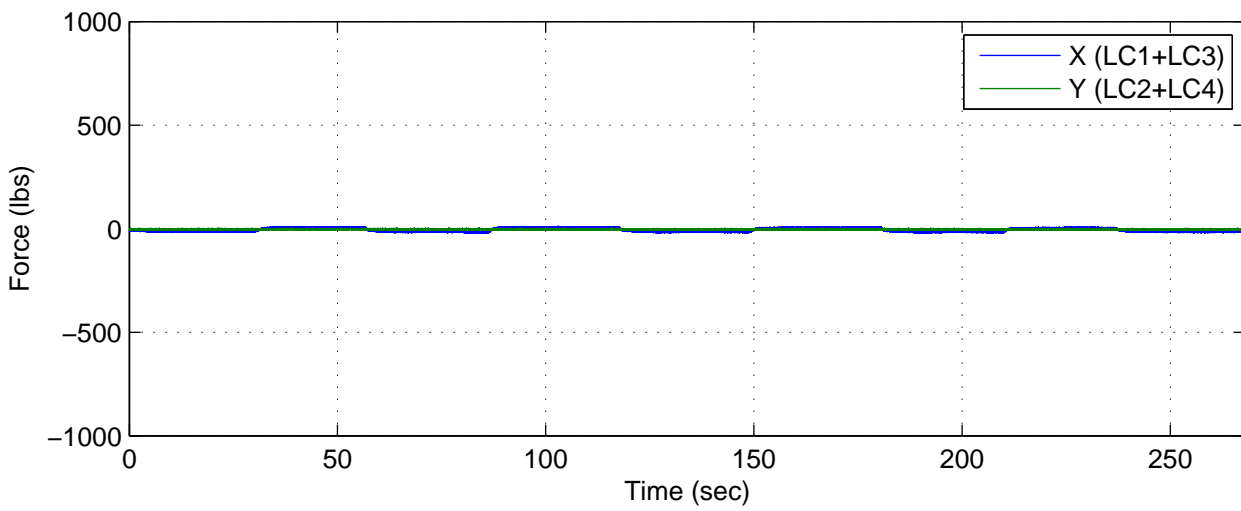
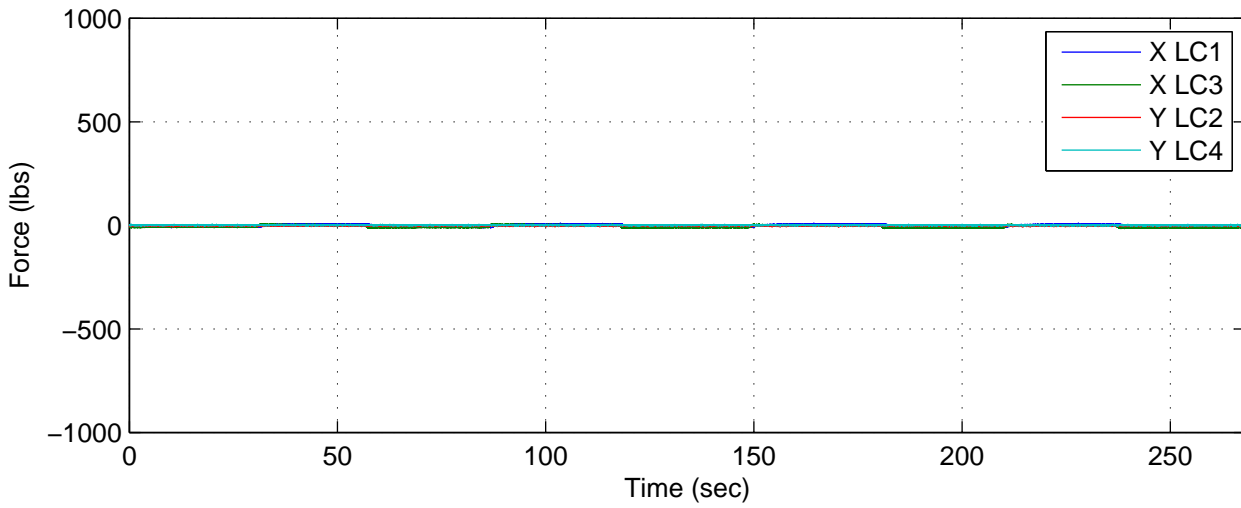
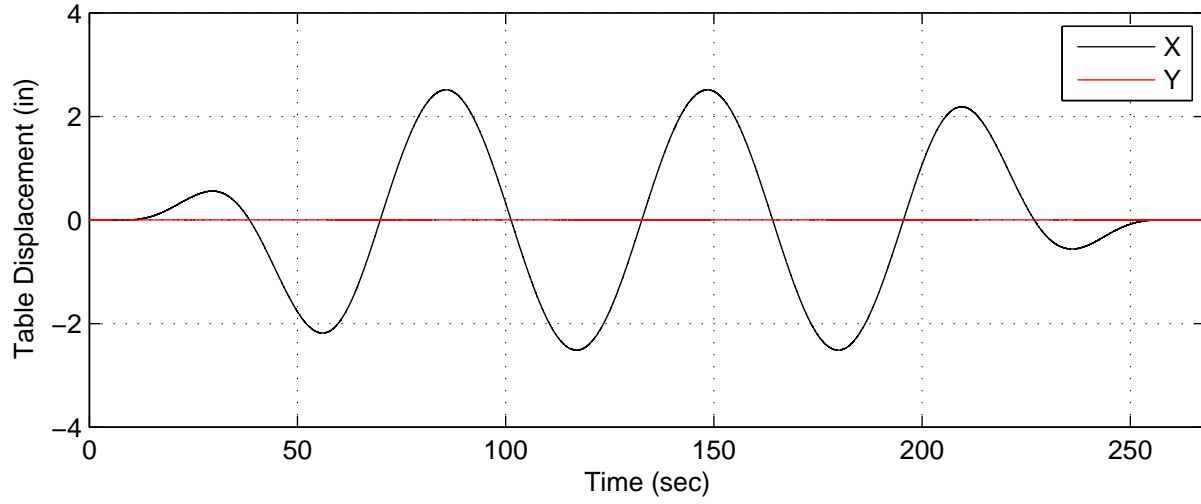

AP4 (No Added Mass) – Test B, 2.5in. Quasi-static X Disp

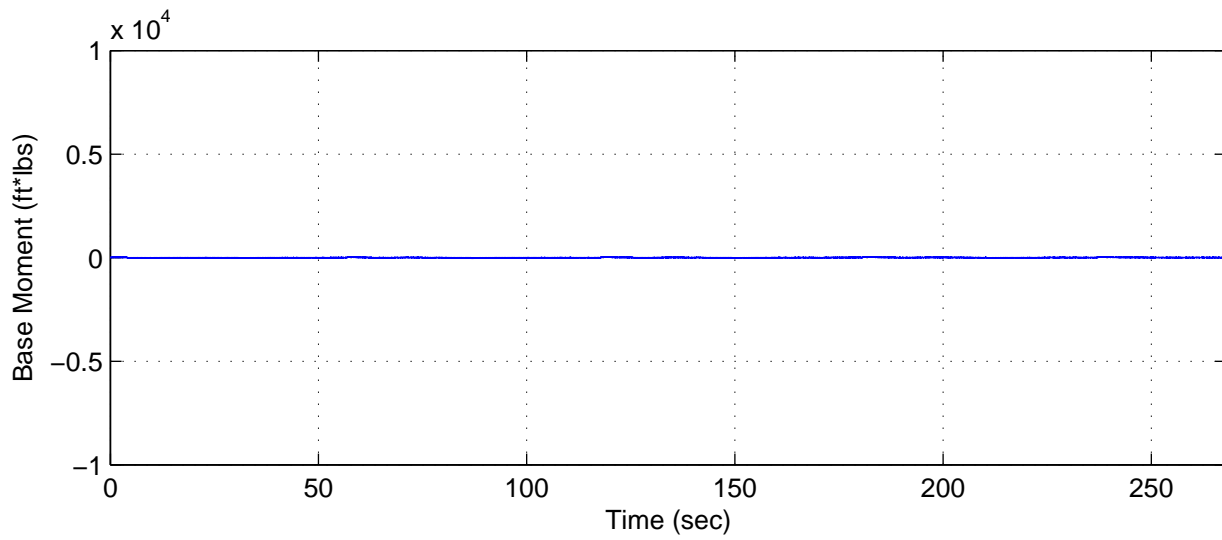
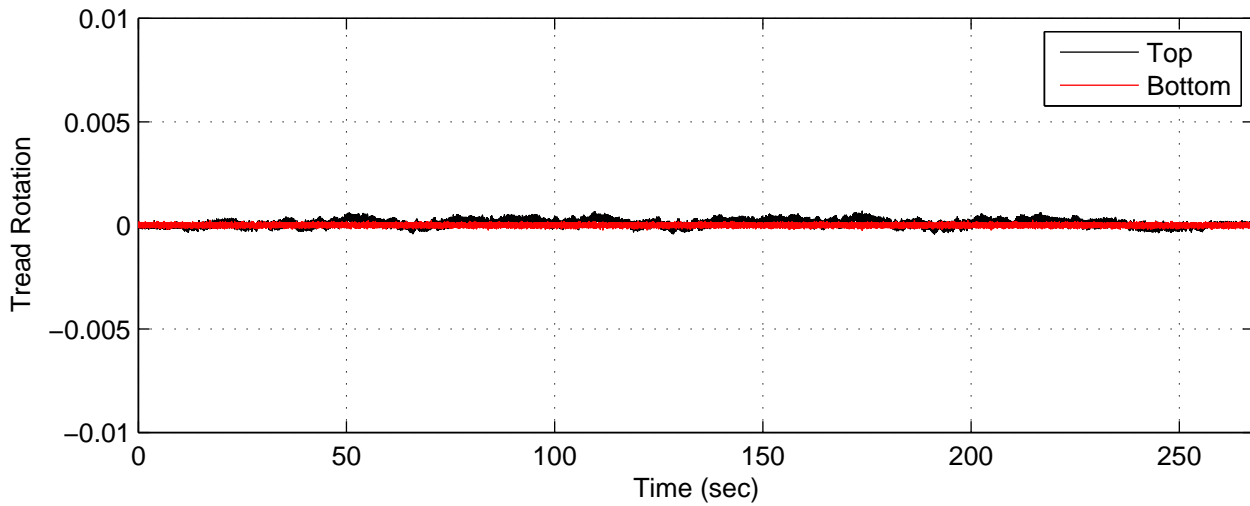
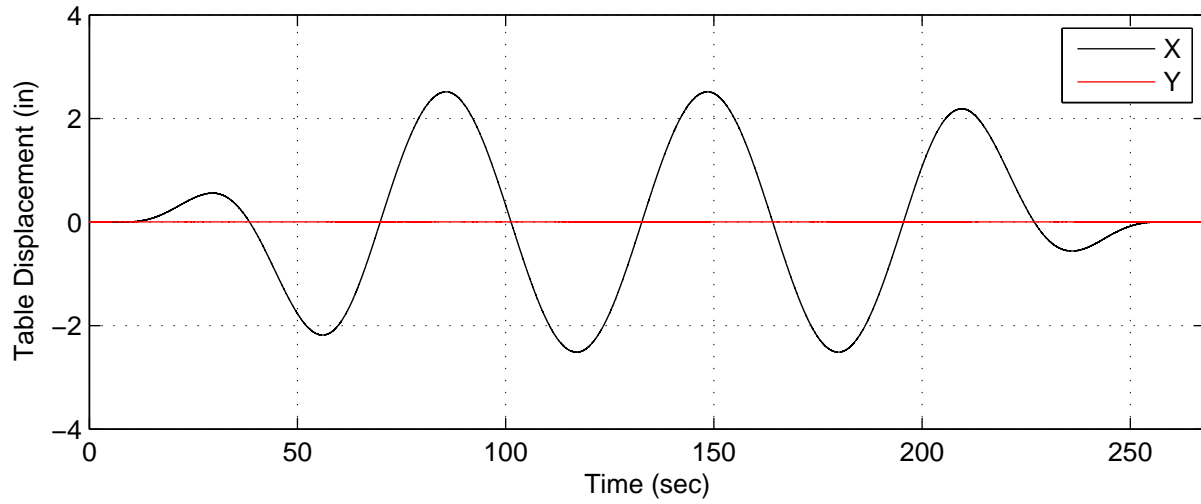

AP4 (No Added Mass) – Test C, 0.5in. Quasi-static Y Disp

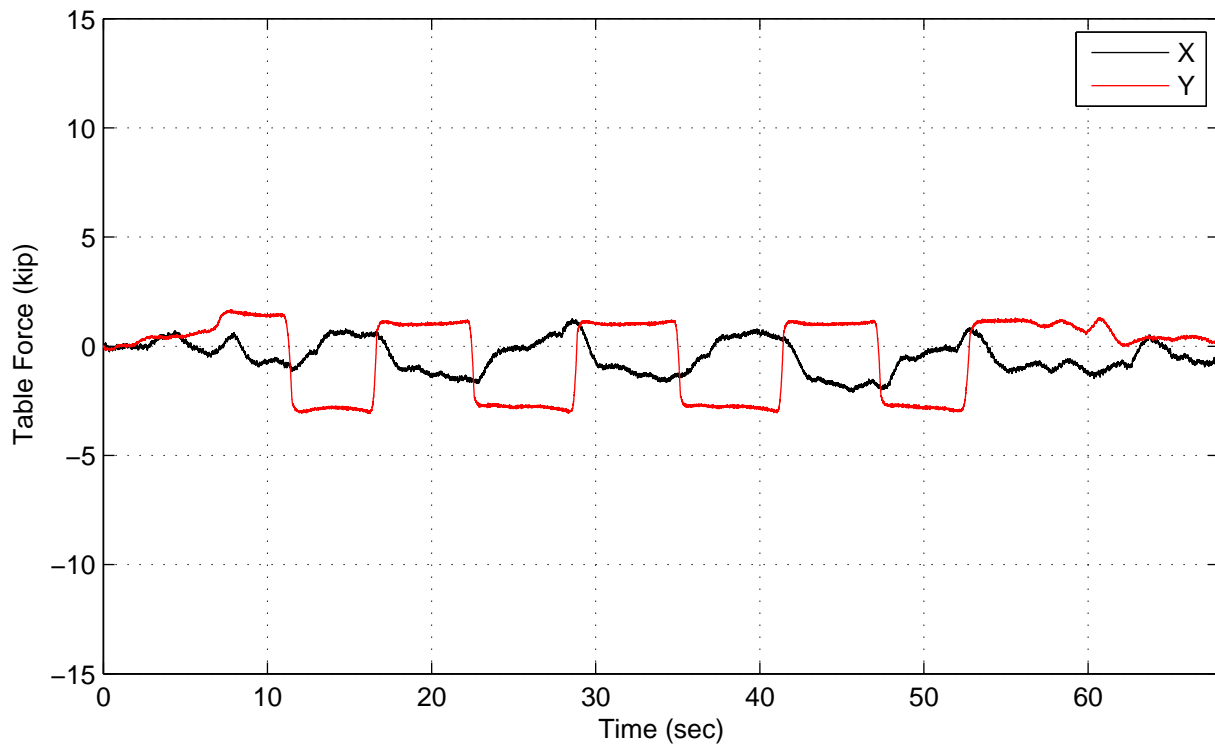
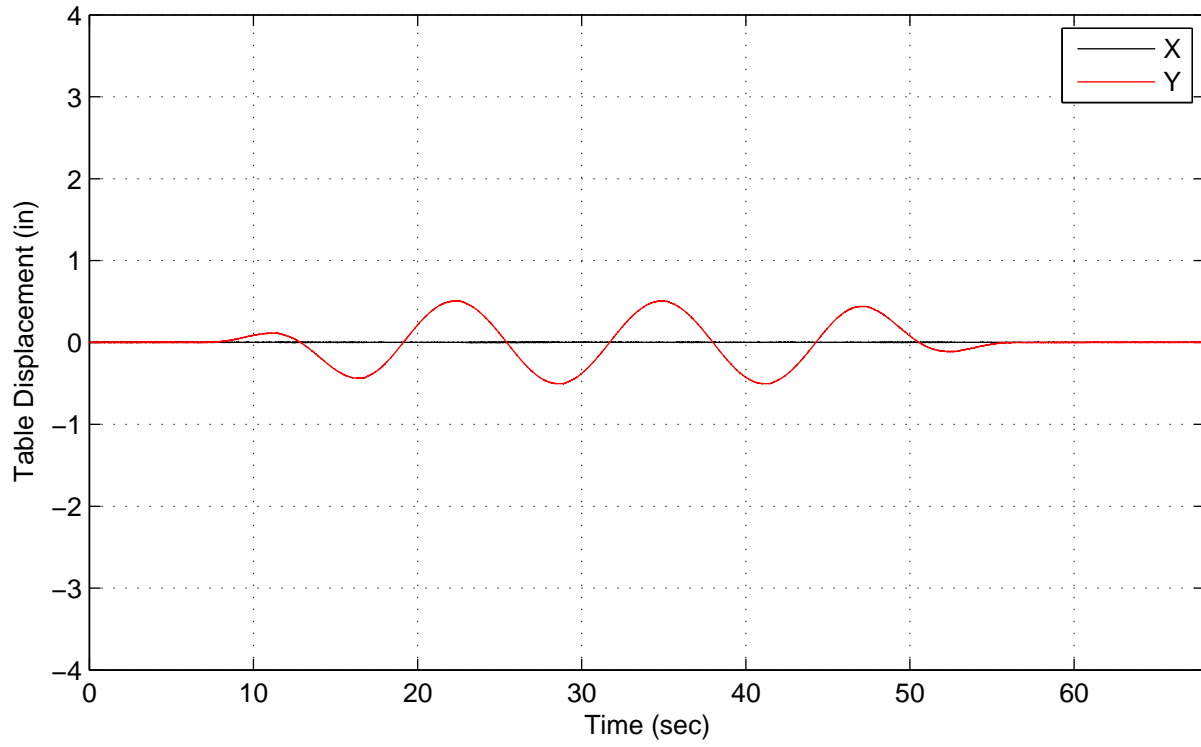

AP4 (No Added Mass) – Test C, 0.5in. Quasi-static Y Disp

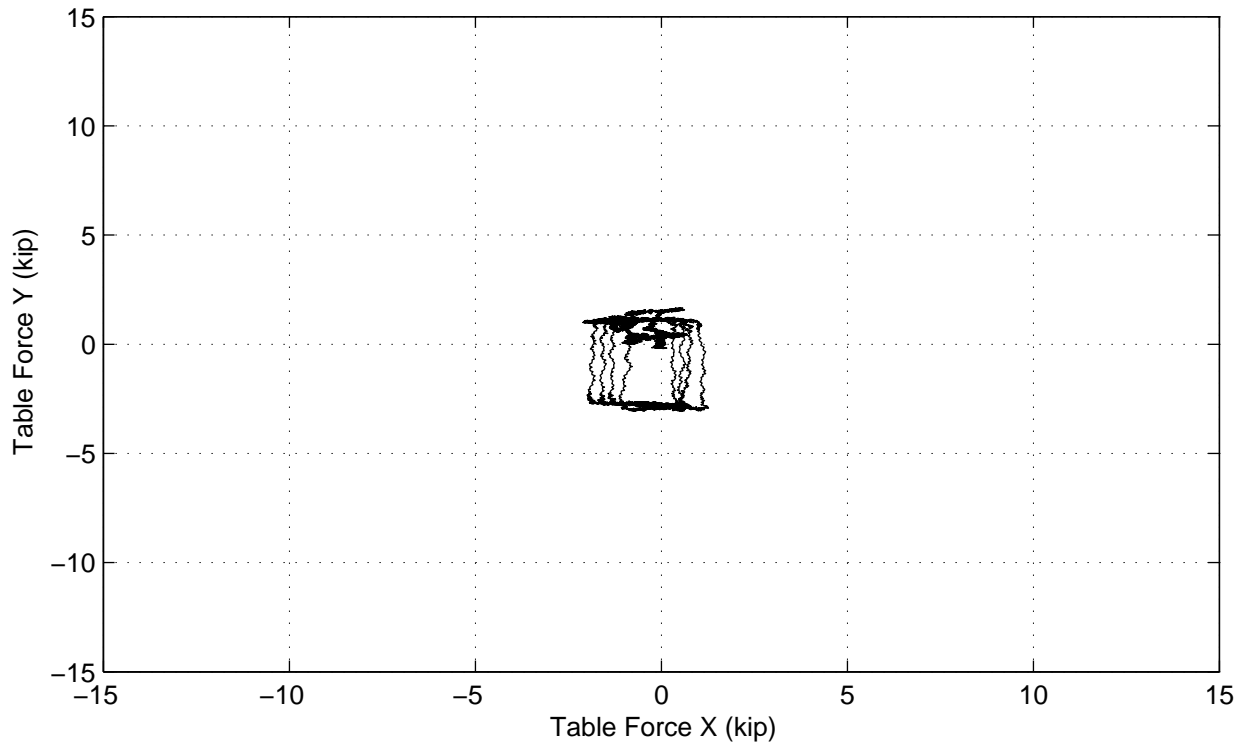
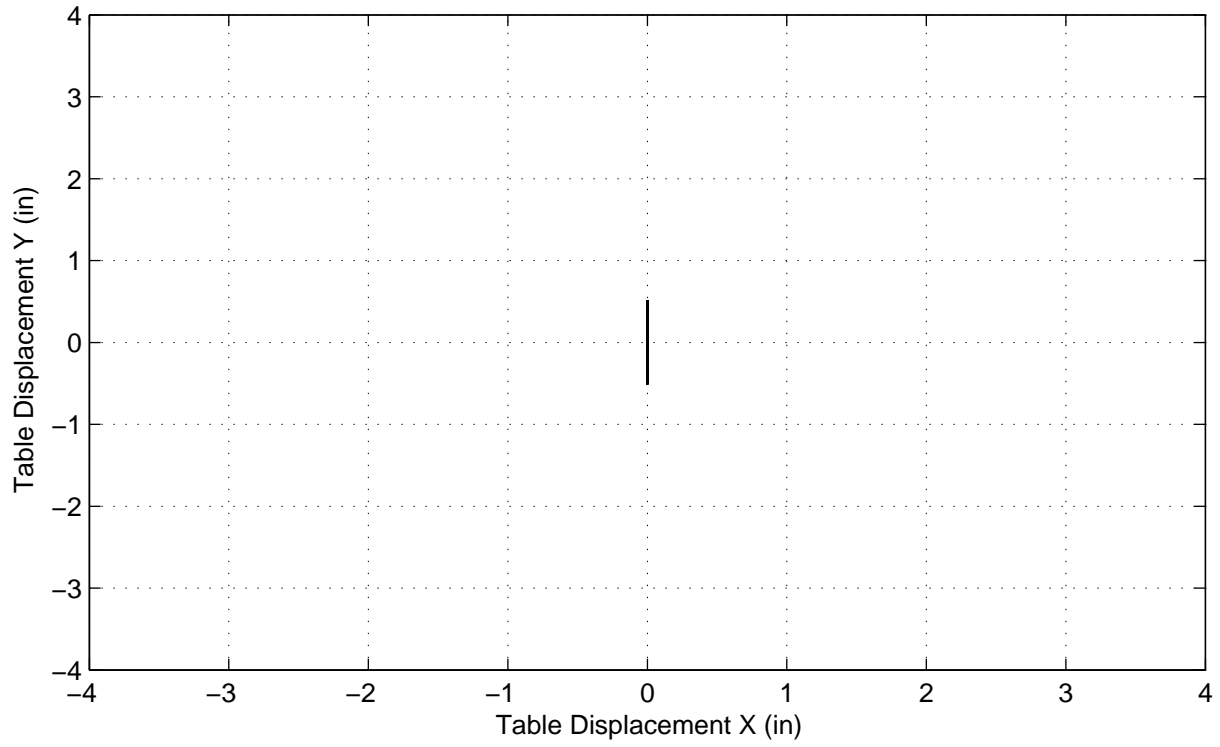

AP4 (No Added Mass) – Test C, 0.5in. Quasi-static Y Disp

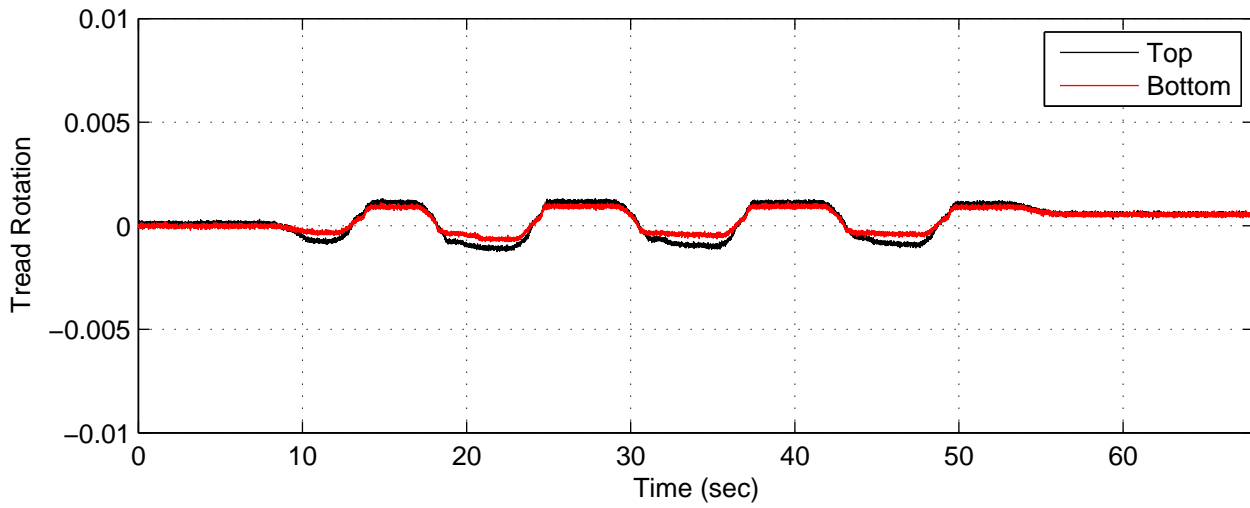
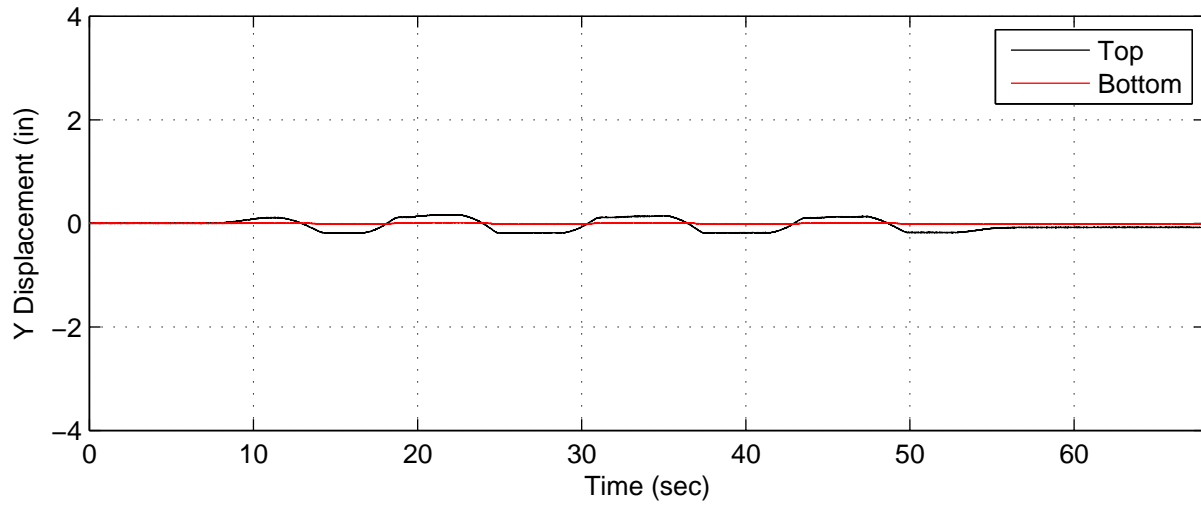
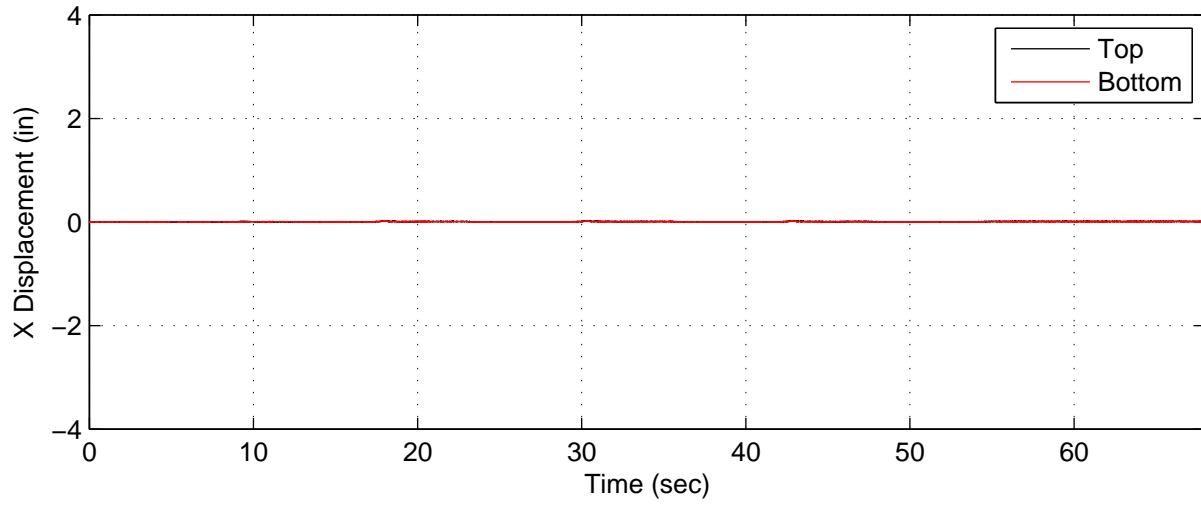

AP4 (No Added Mass) – Test C, 0.5in. Quasi-static Y Disp

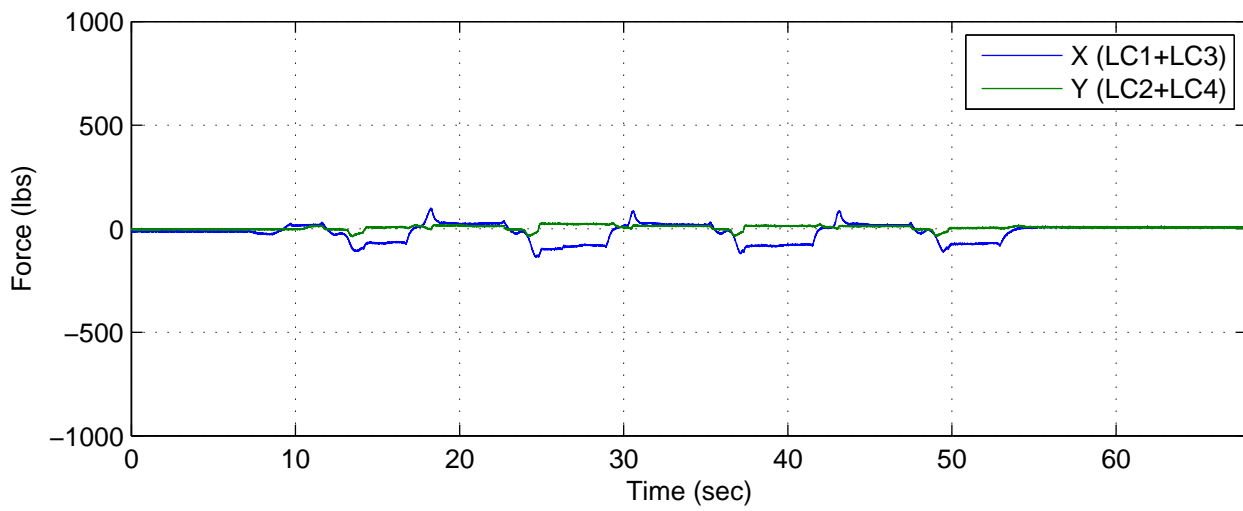
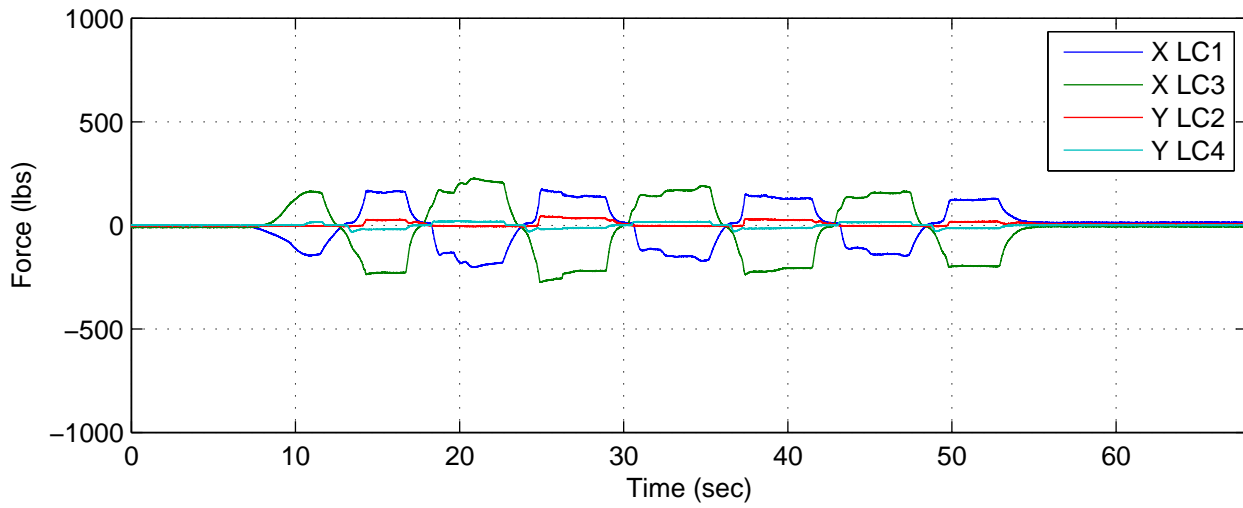
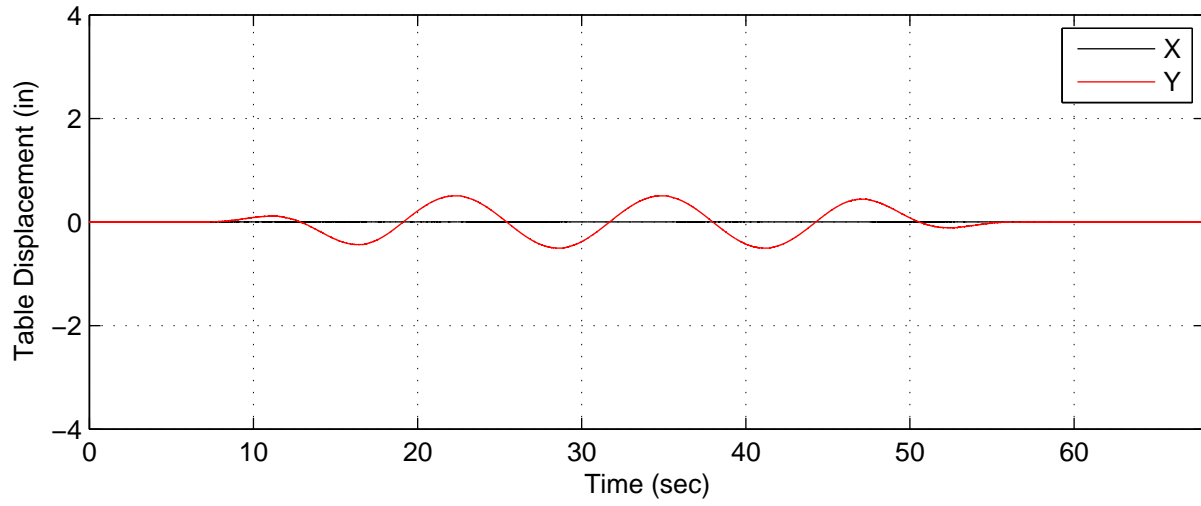

AP4 (No Added Mass) – Test C, 0.5in. Quasi-static Y Disp

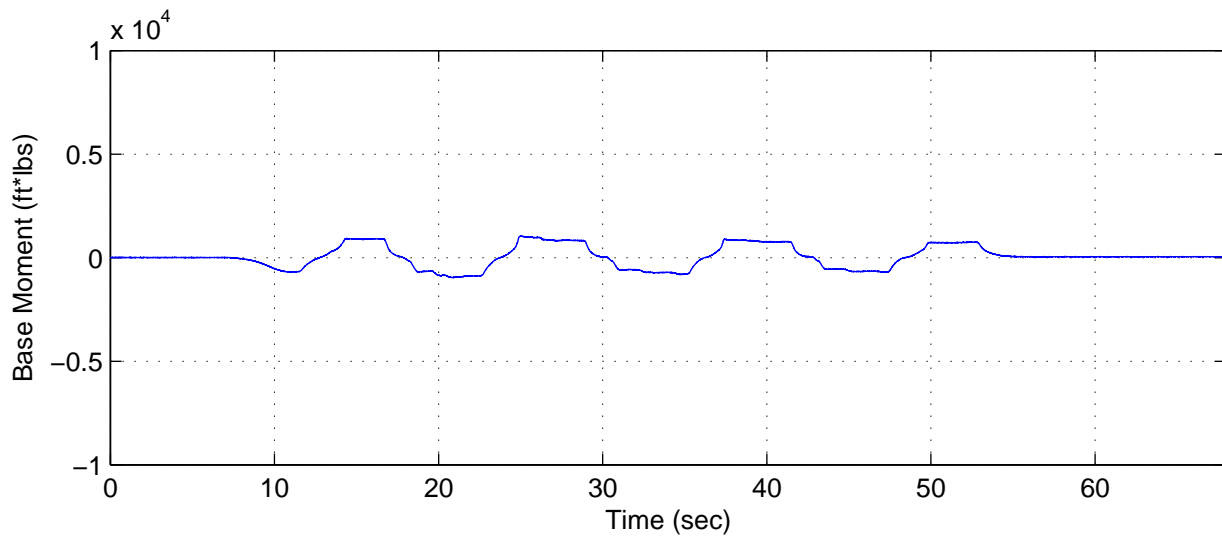
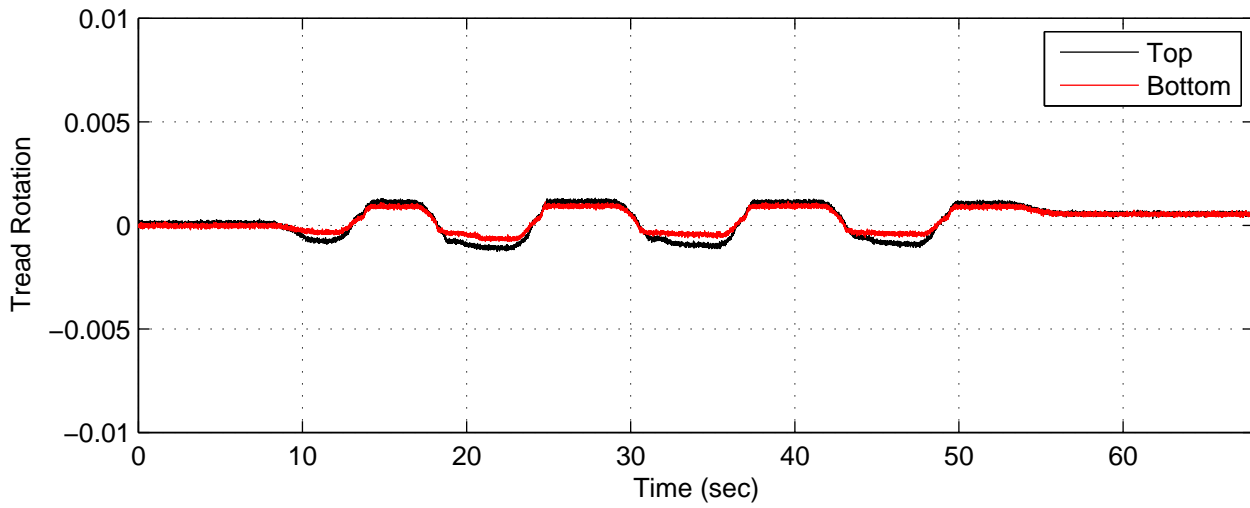
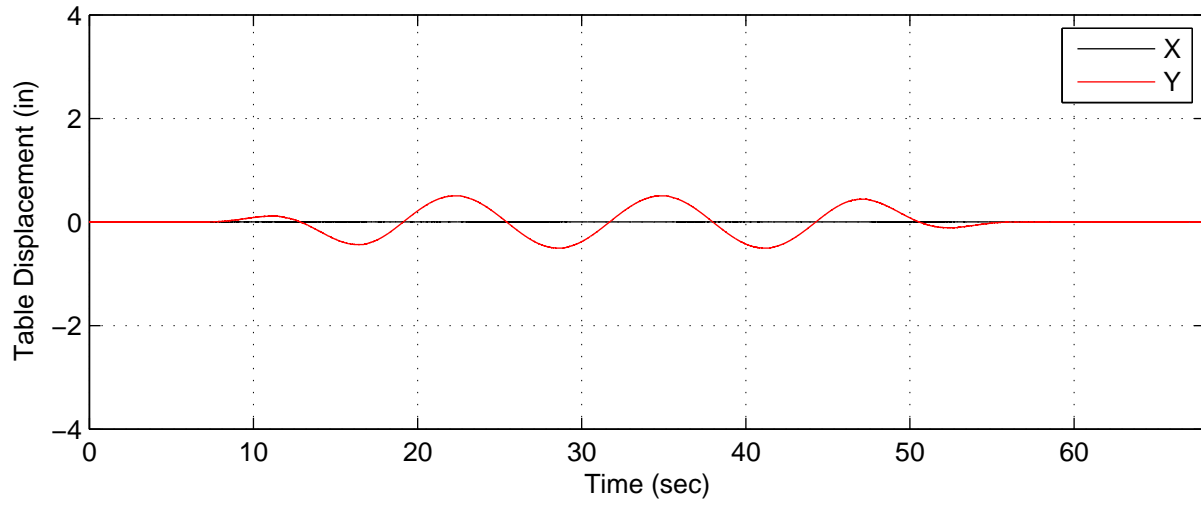

AP4 (No Added Mass) – Test D, 2.5in. Quasi-static Y Disp

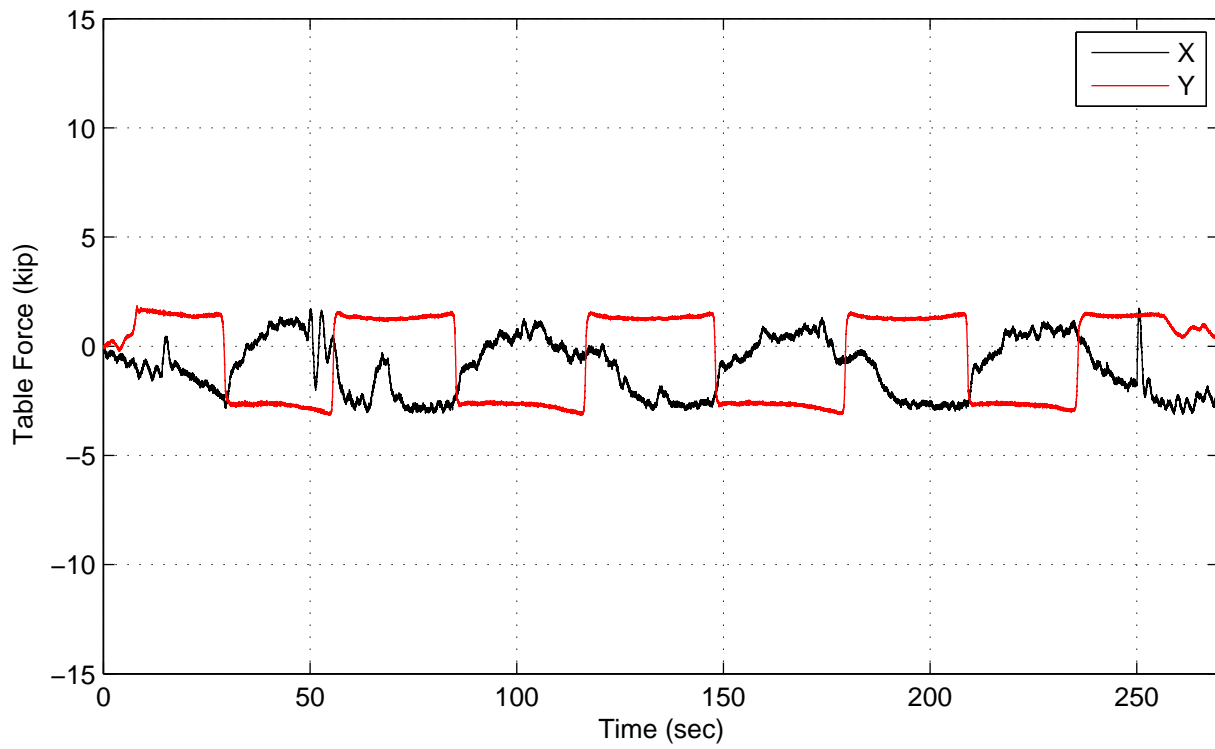
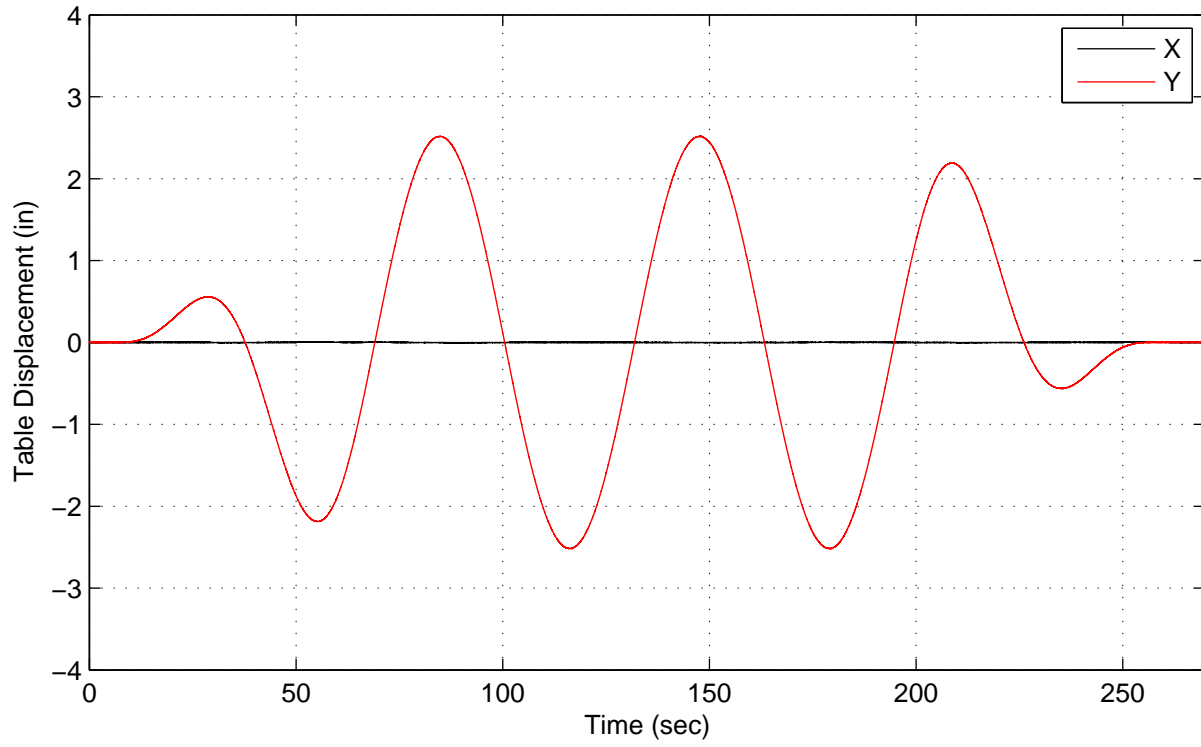



AP4 (No Added Mass) – Test D, 2.5in. Quasi-static Y Disp

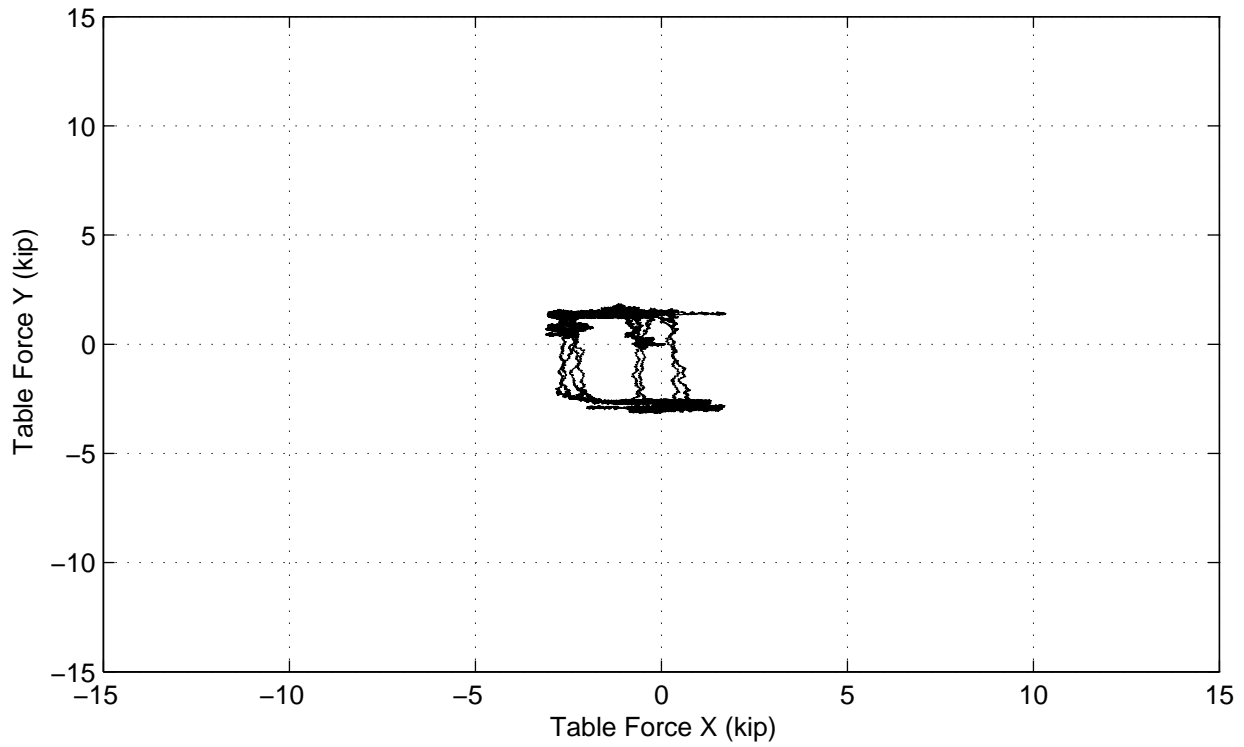
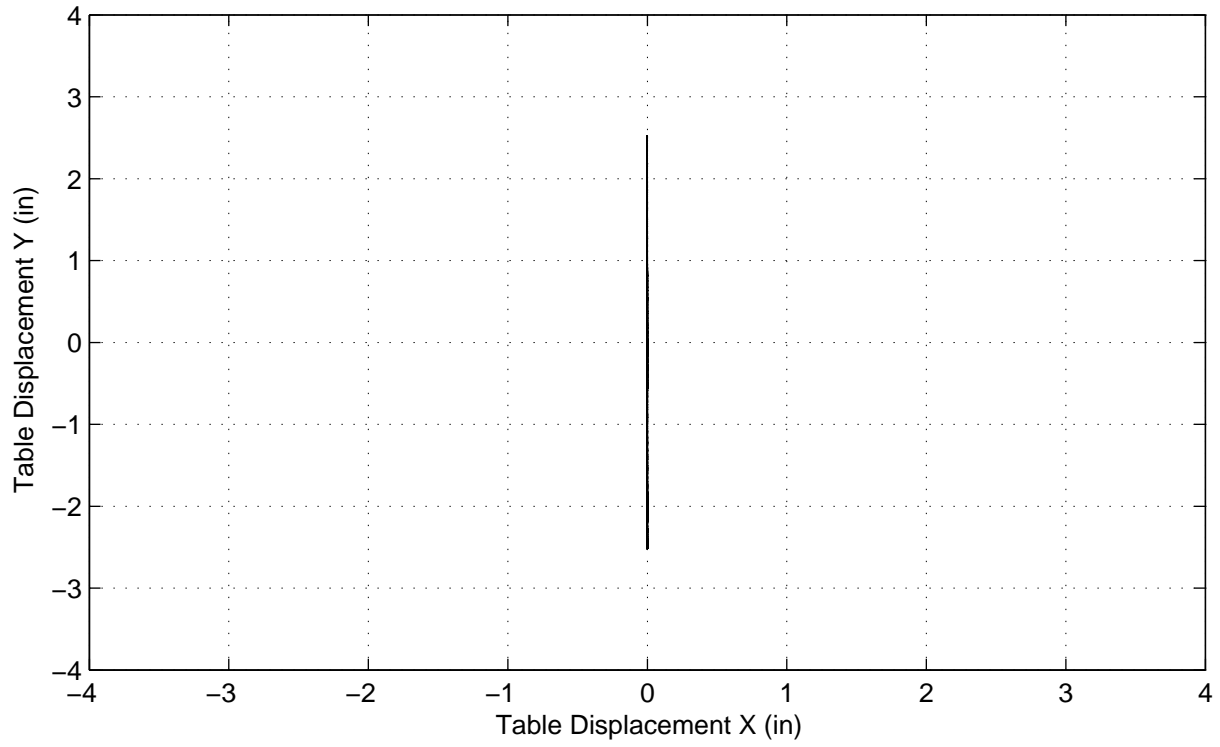

AP4 (No Added Mass) – Test D, 2.5in. Quasi-static Y Disp

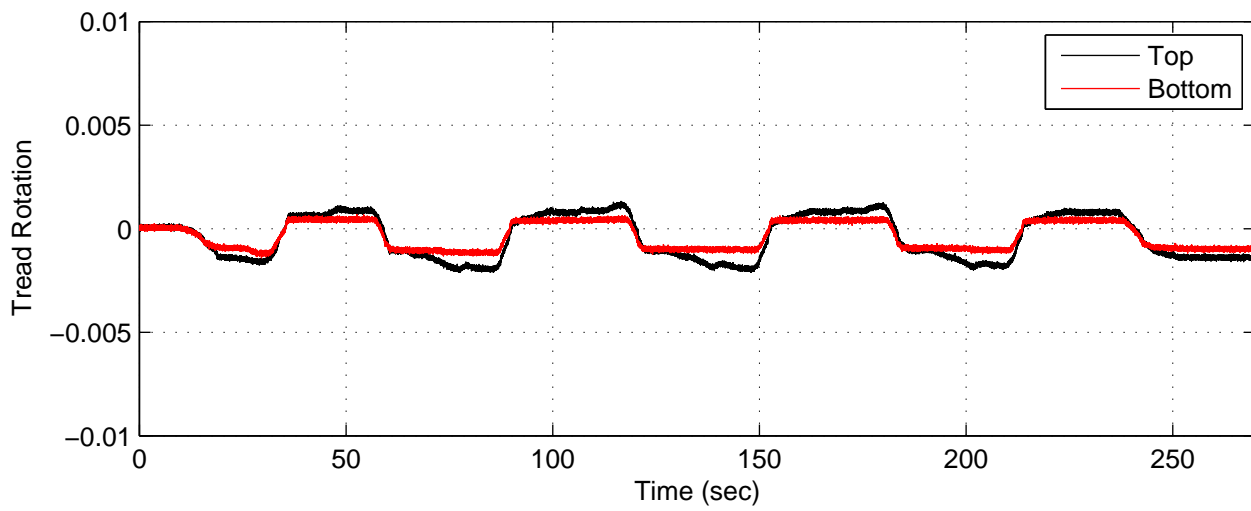
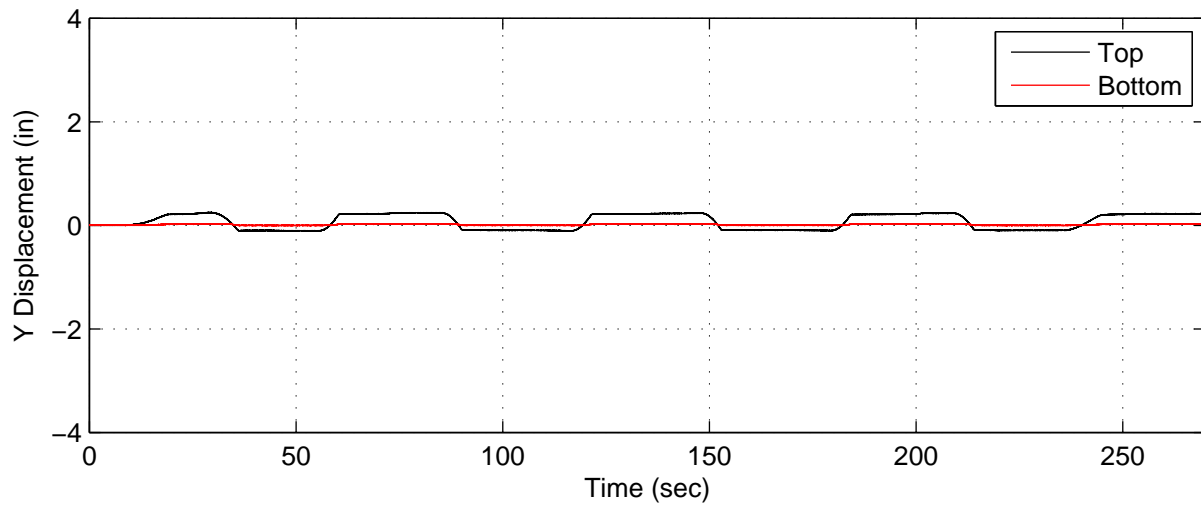
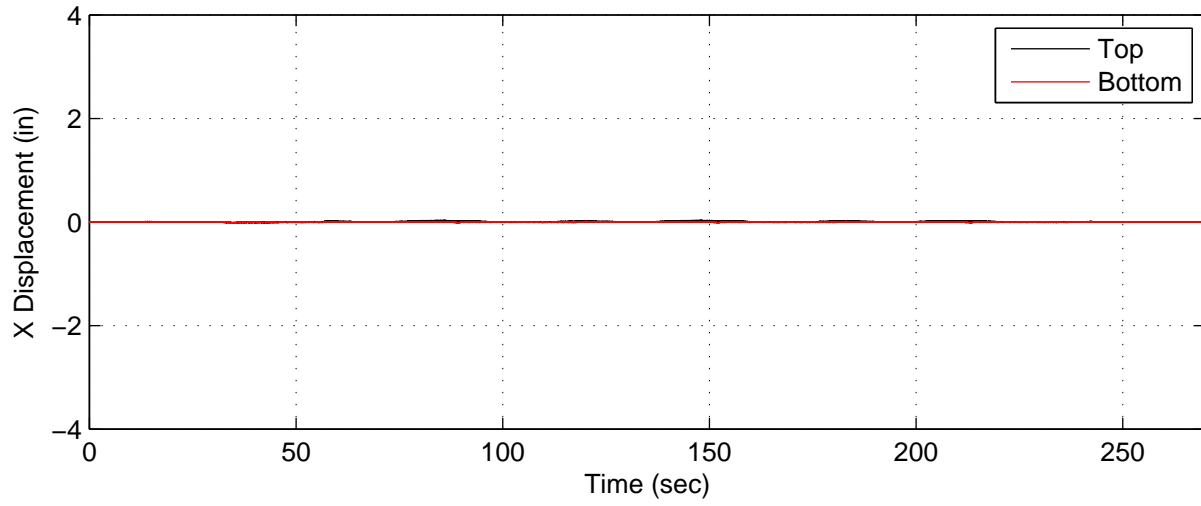

AP4 (No Added Mass) – Test D, 2.5in. Quasi-static Y Disp

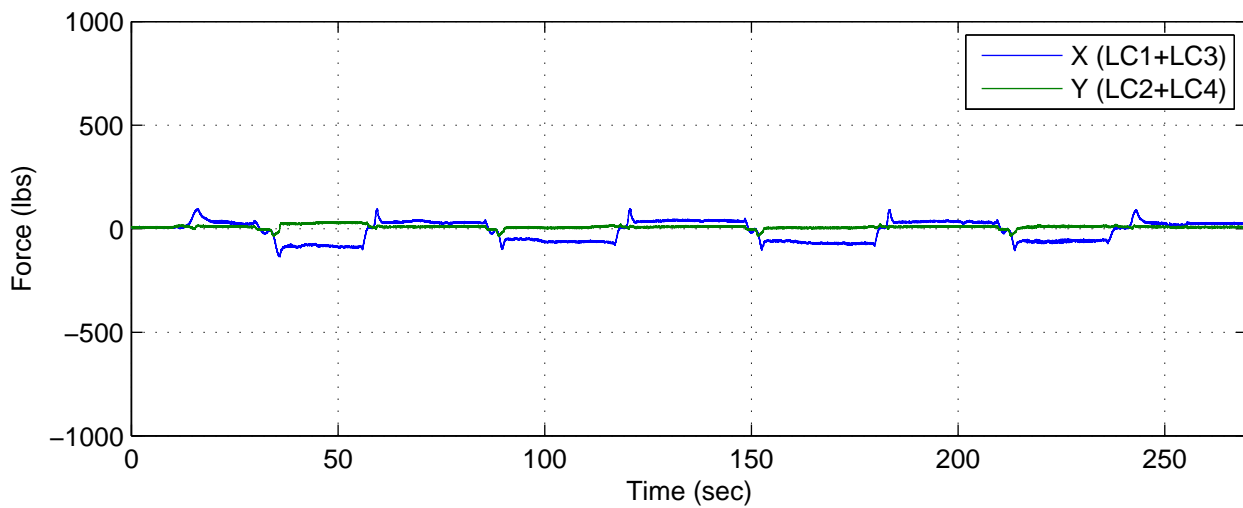
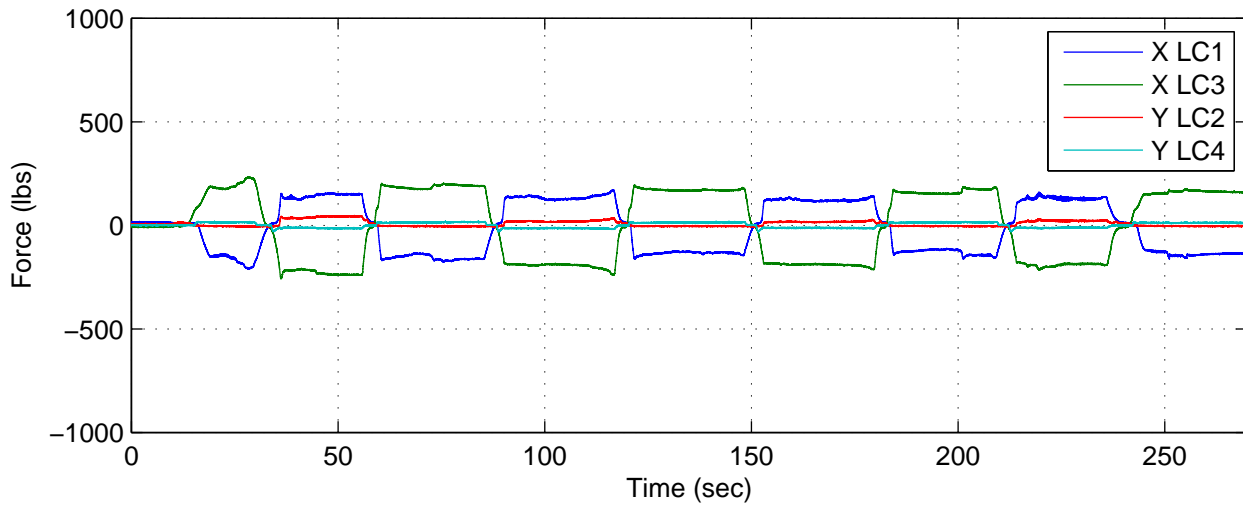
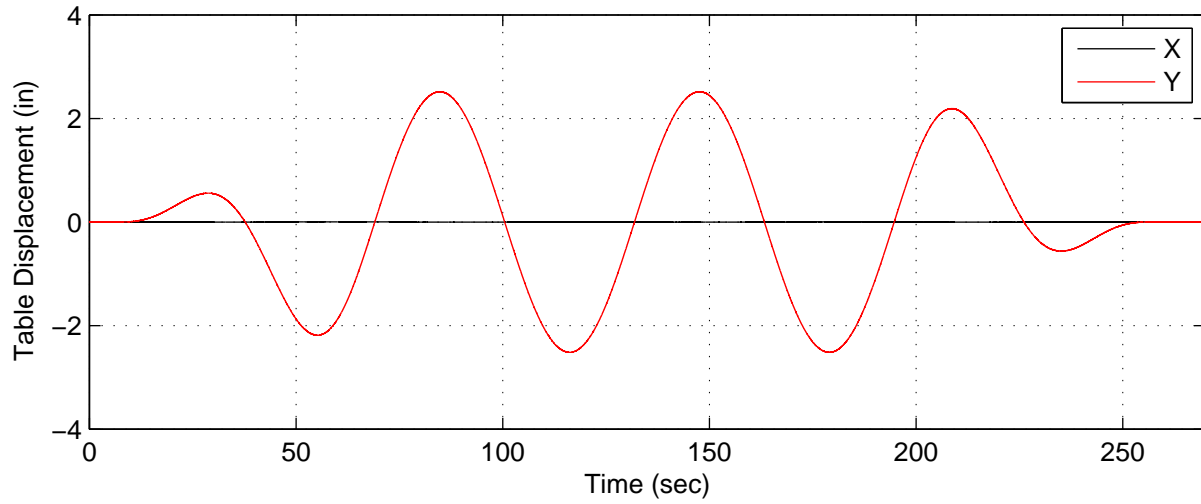

AP4 (No Added Mass) – Test D, 2.5in. Quasi-static Y Disp

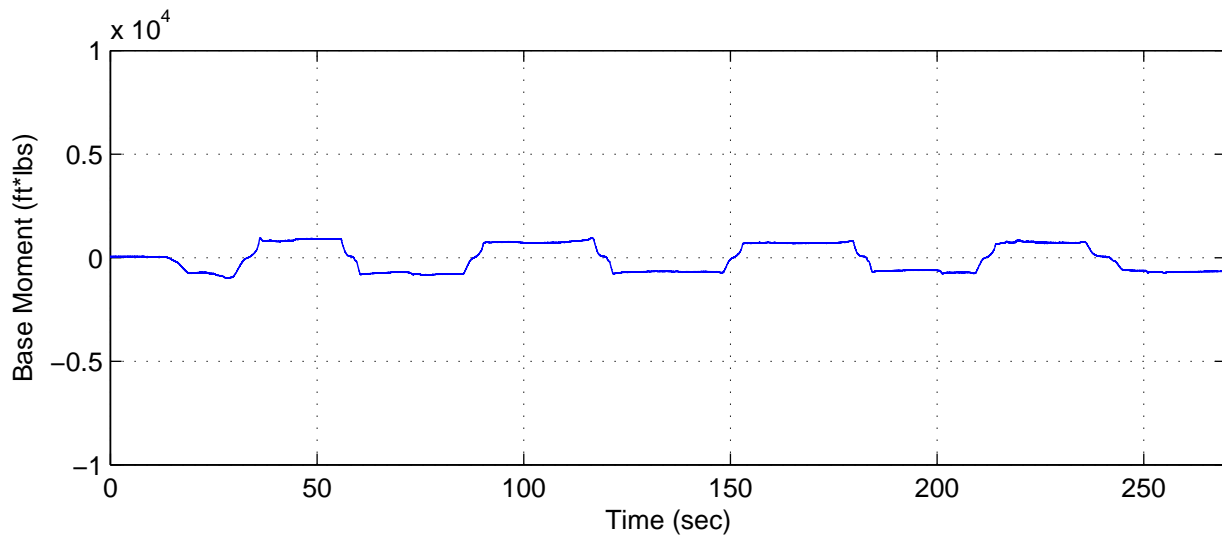
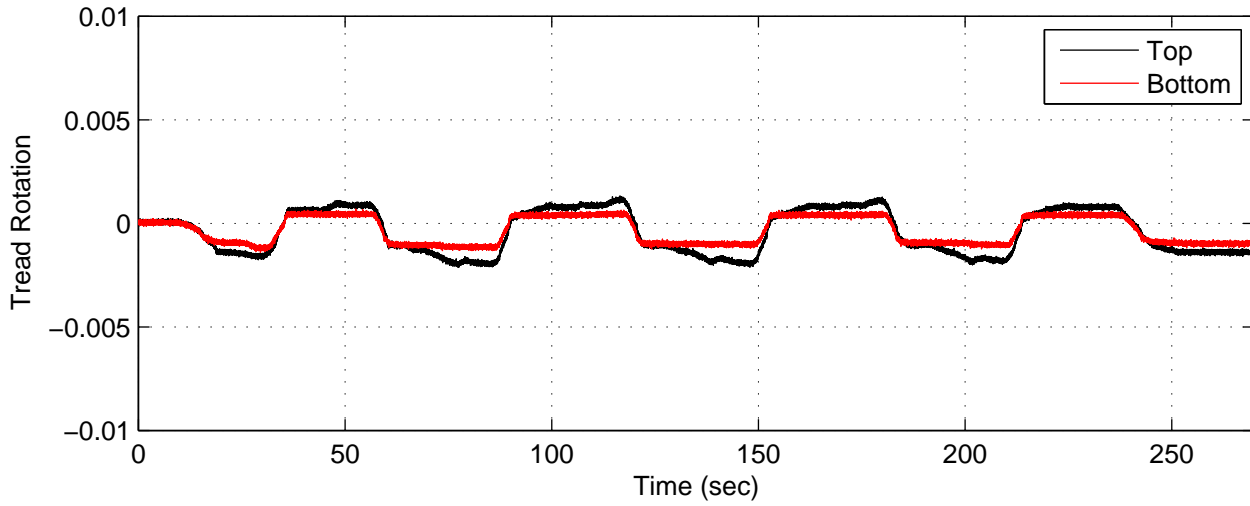
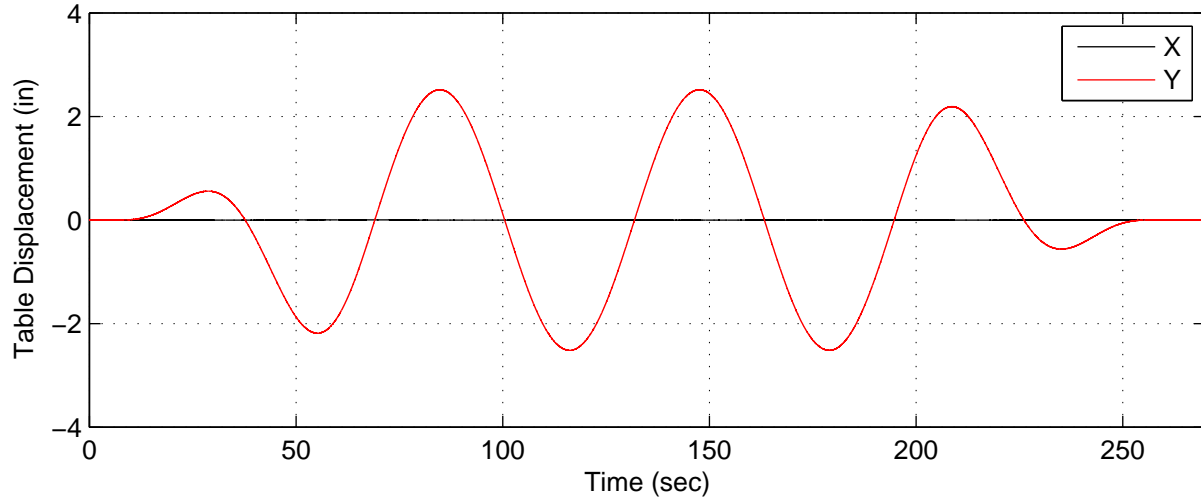

AP4 (No Added Mass) – Test E, 0.5in. Dynamic X Disp

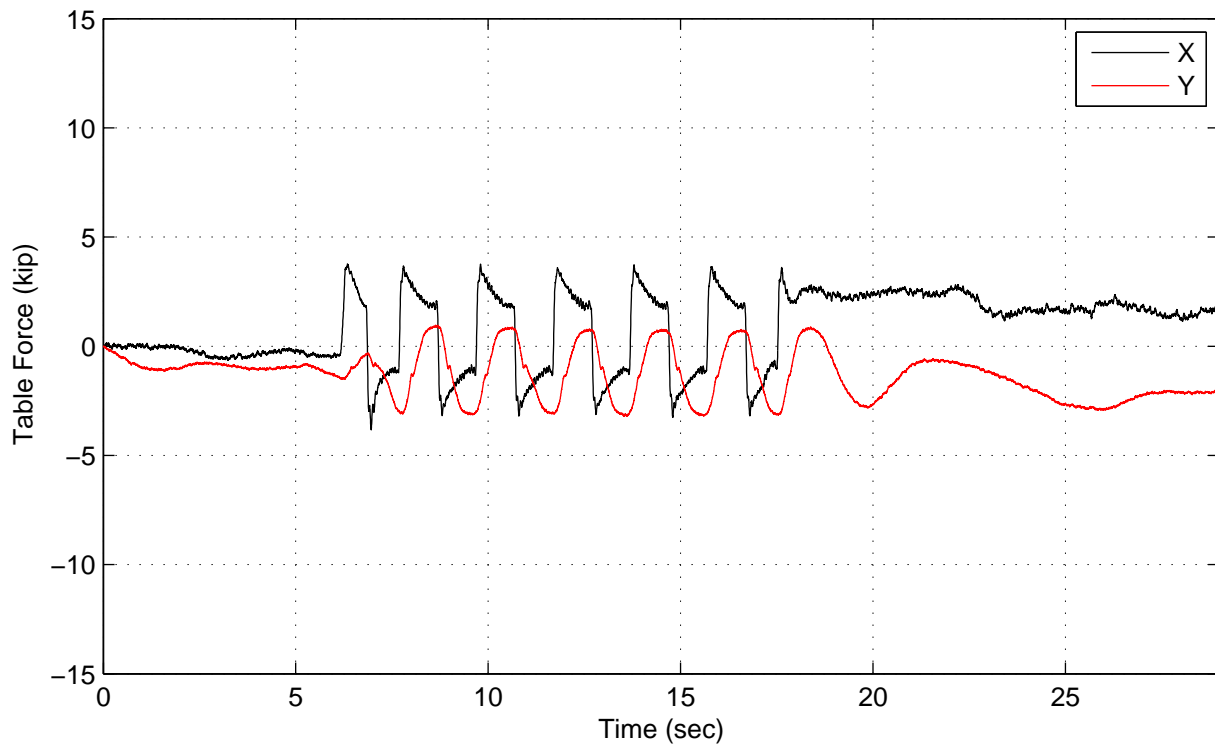
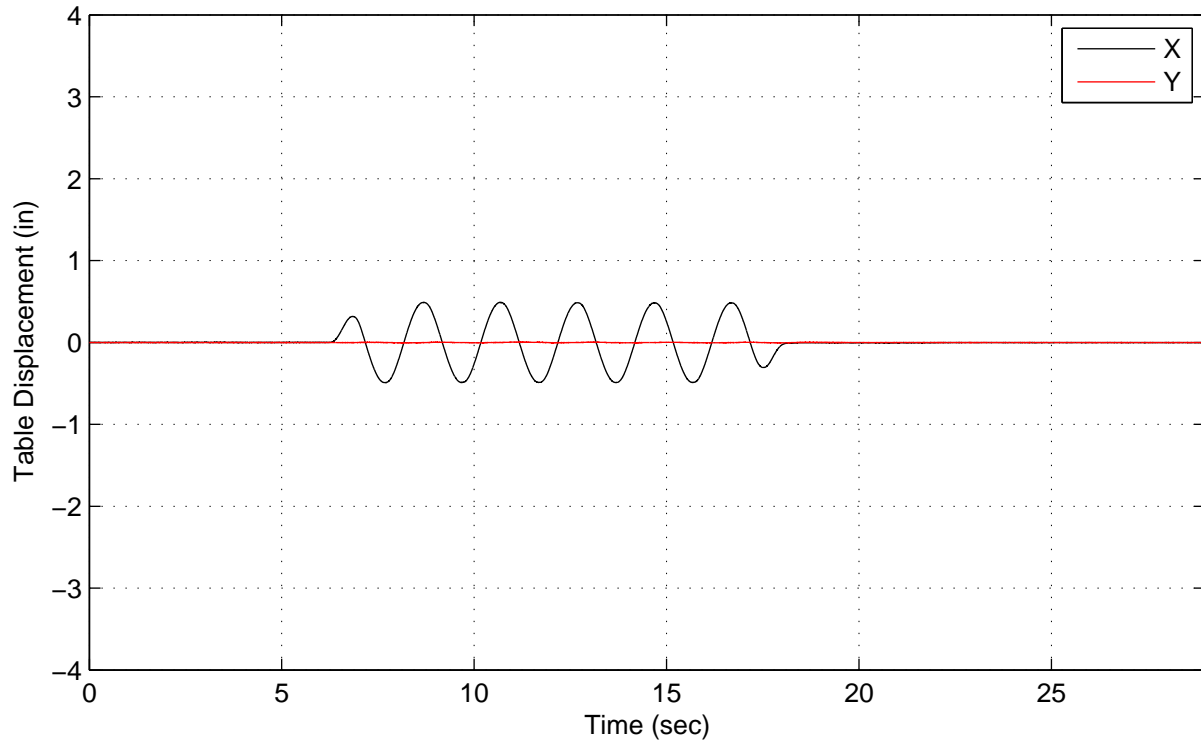

AP4 (No Added Mass) – Test E, 0.5in. Dynamic X Disp

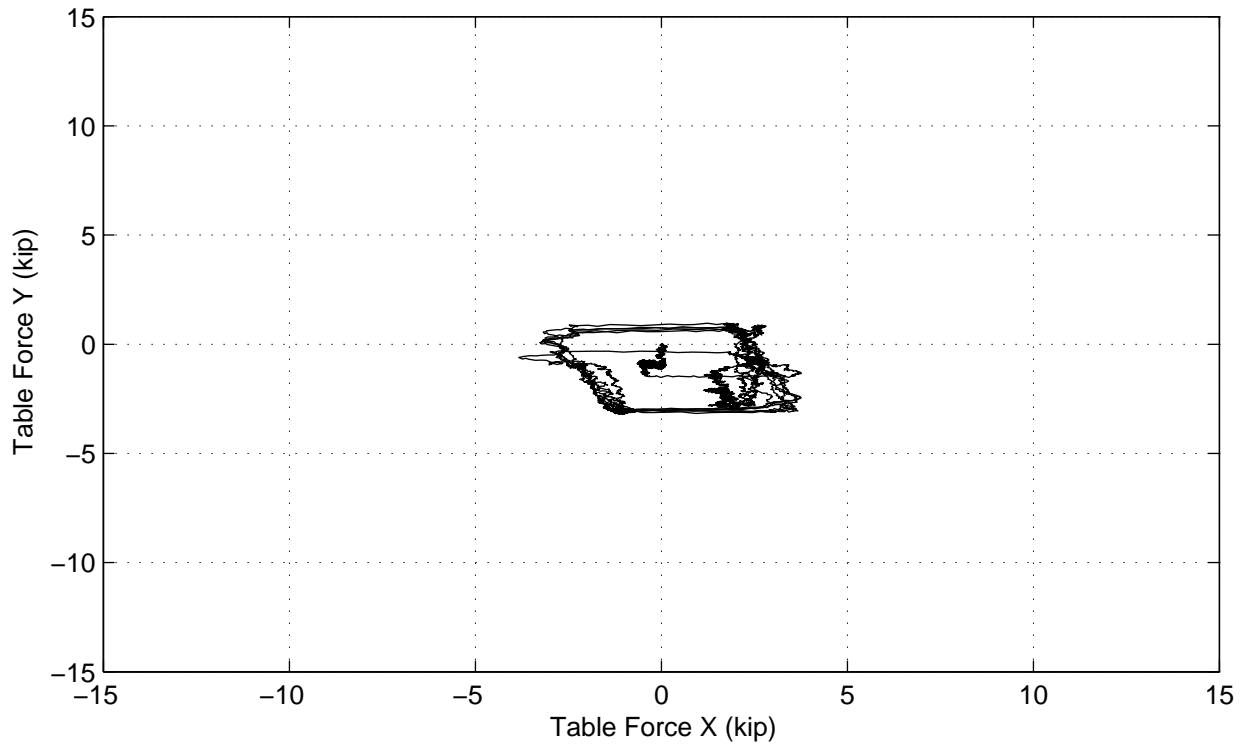
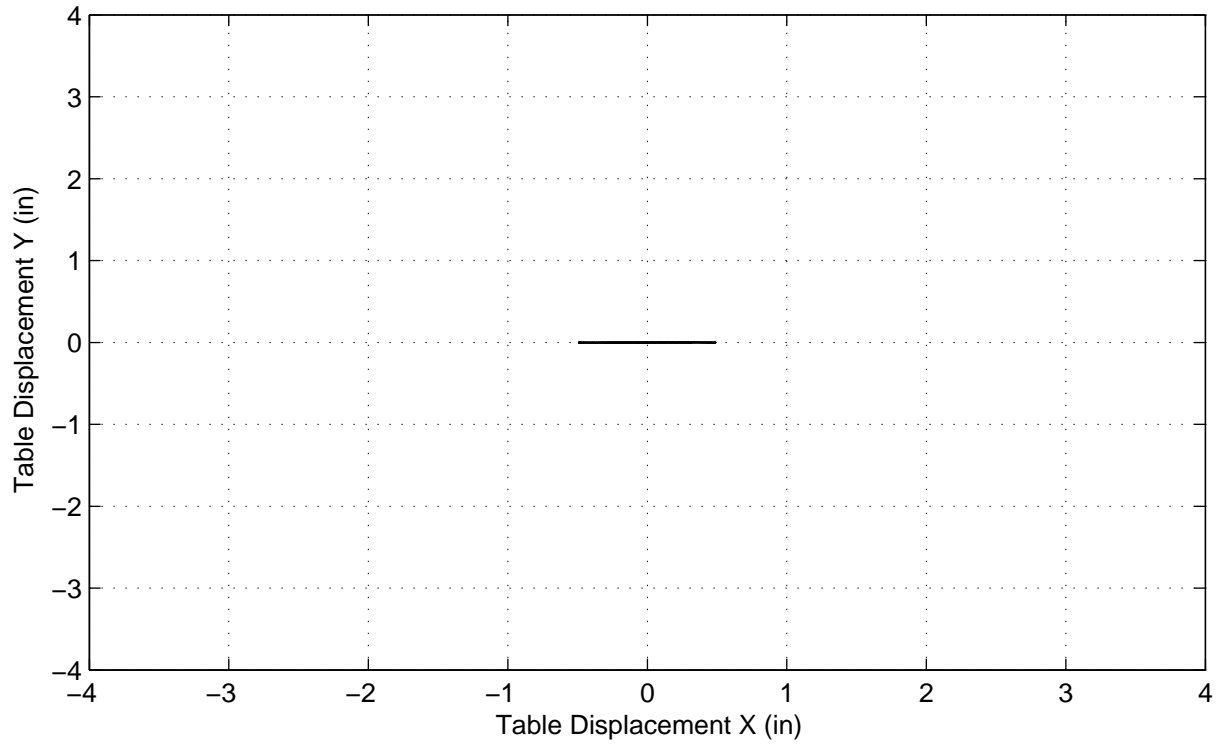

AP4 (No Added Mass) – Test E, 0.5in. Dynamic X Disp

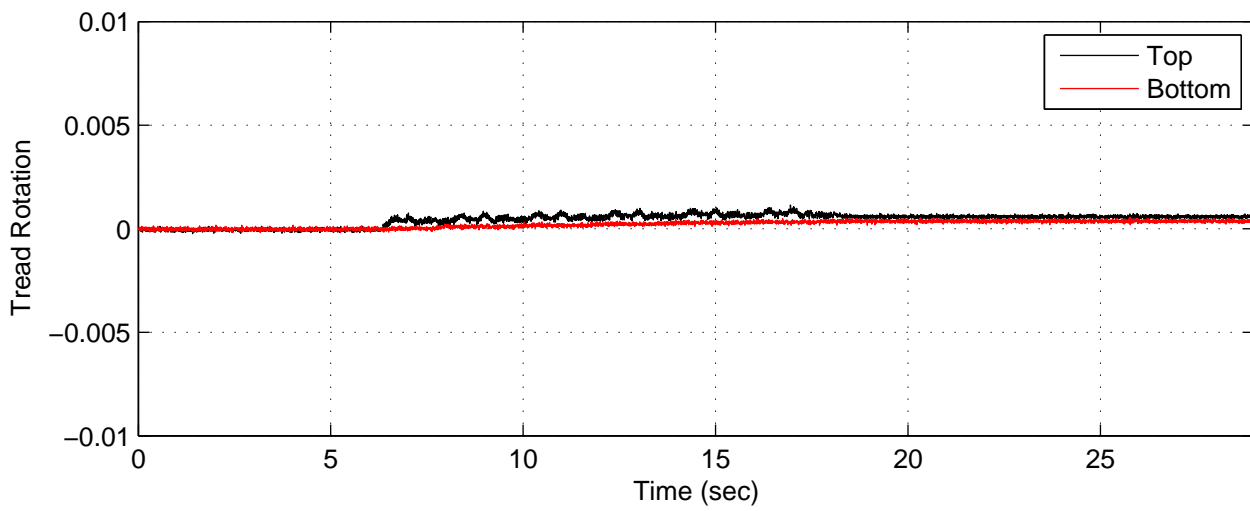
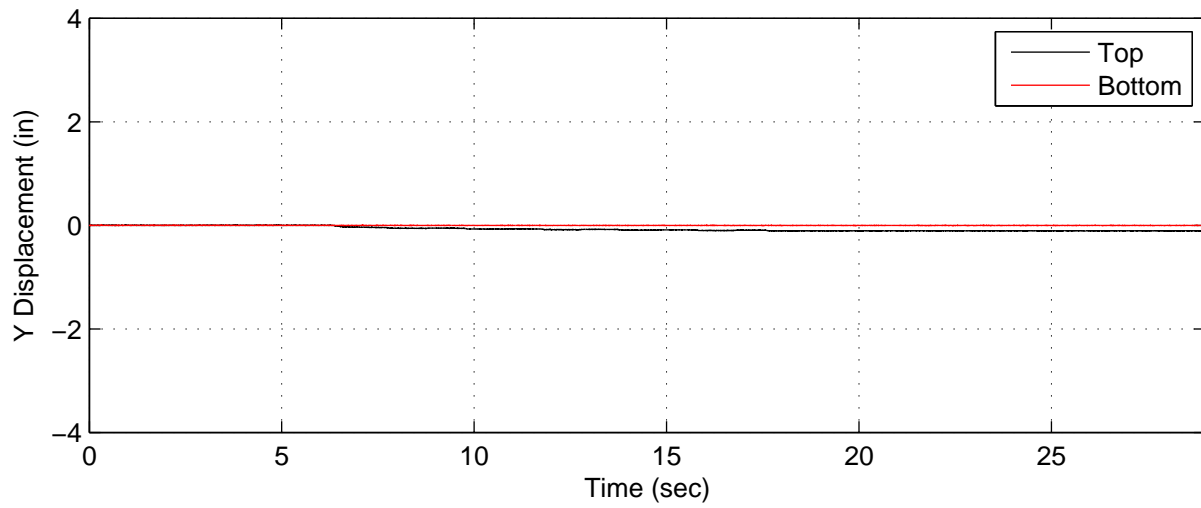
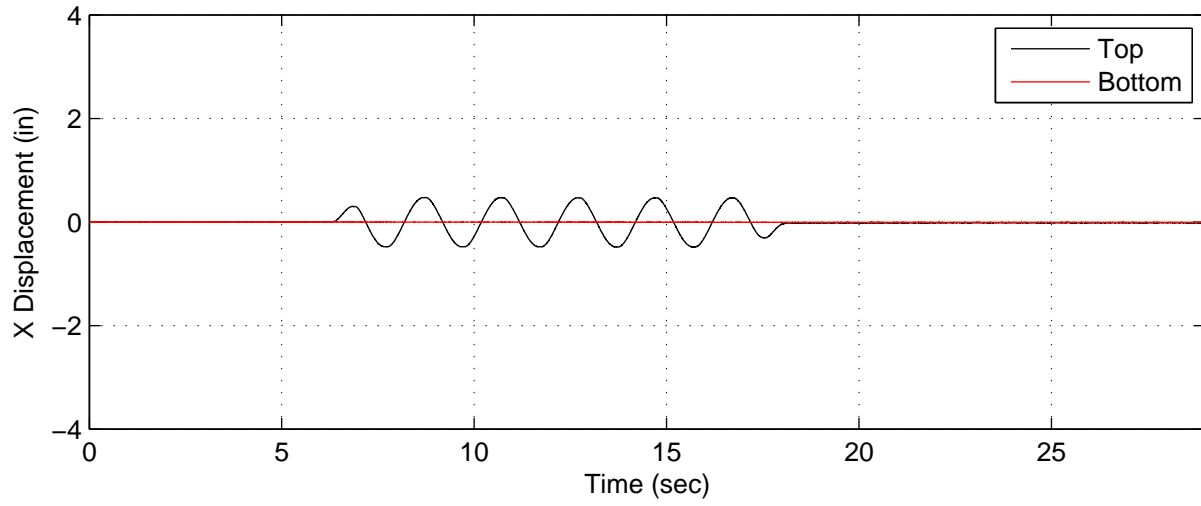

AP4 (No Added Mass) – Test E, 0.5in. Dynamic X Disp

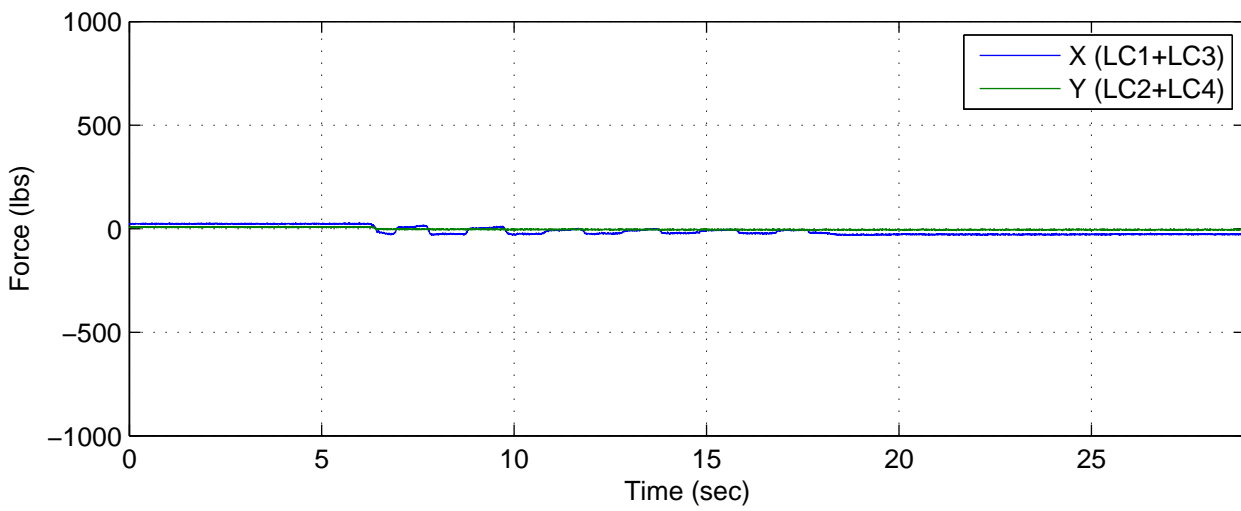
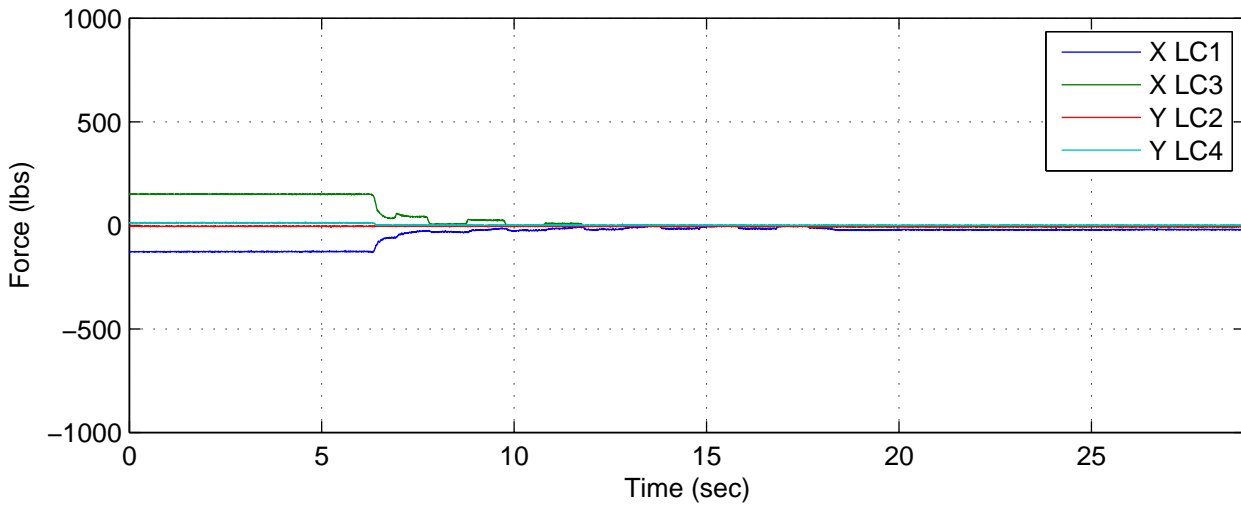
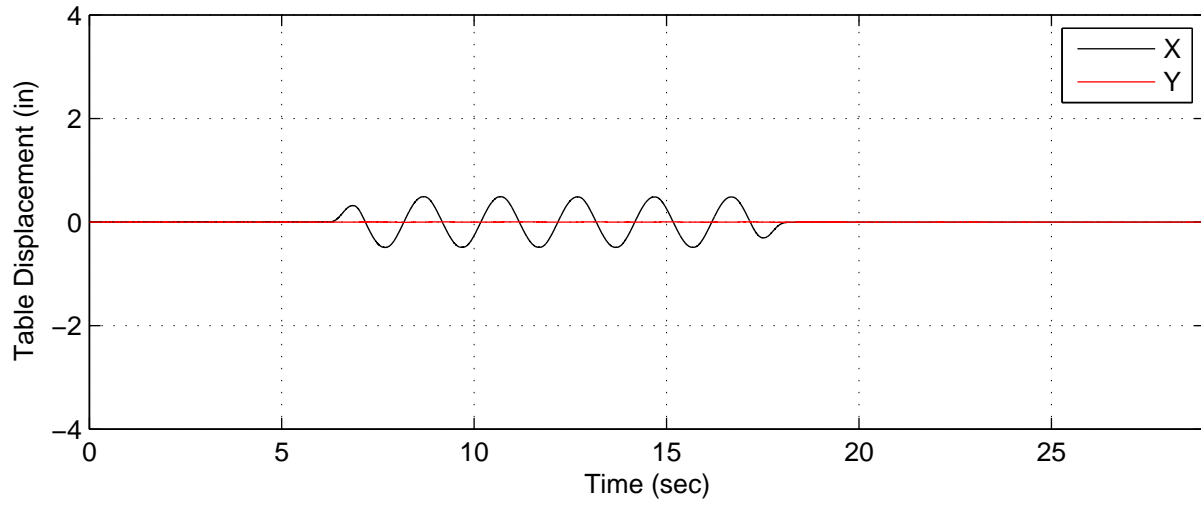



AP4 (No Added Mass) – Test E, 0.5in. Dynamic X Disp

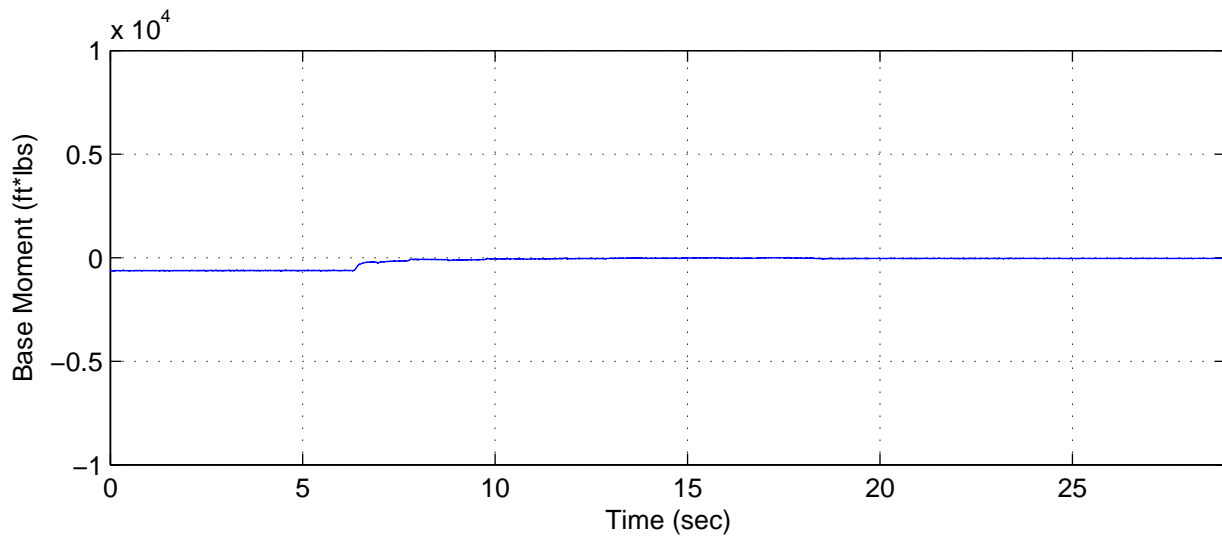
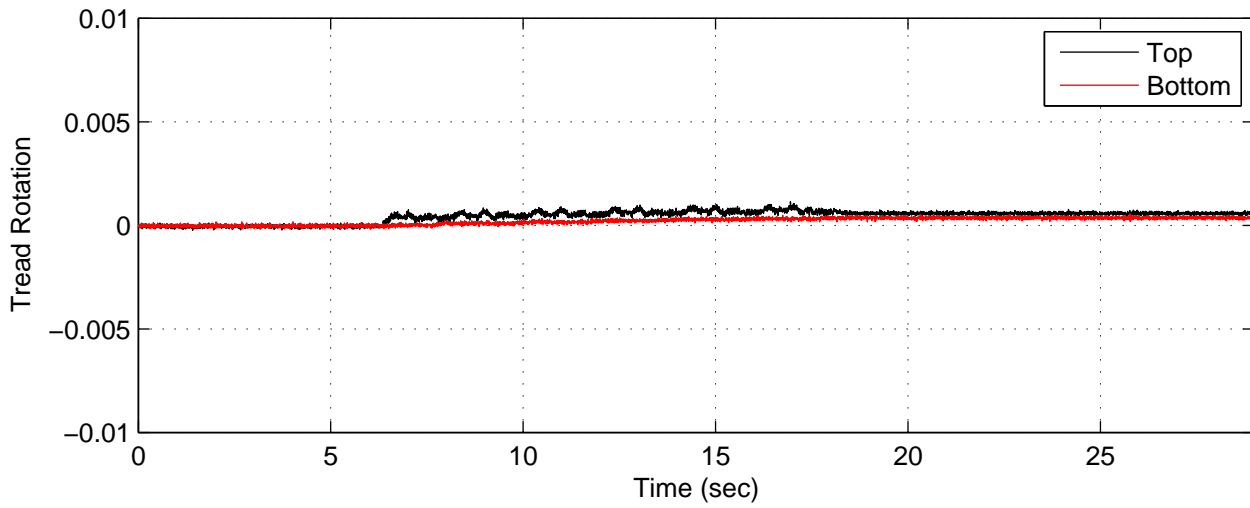
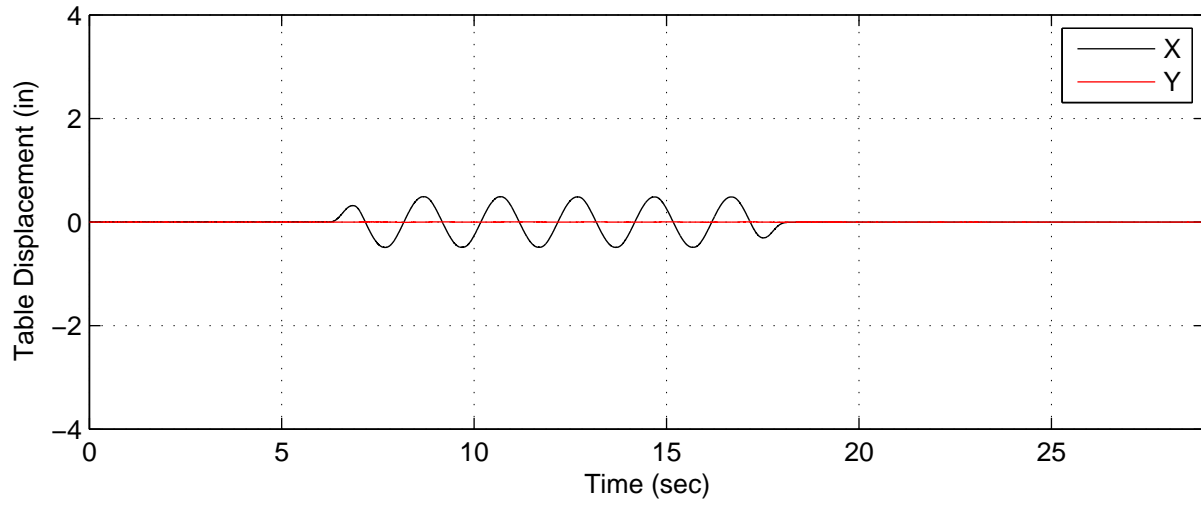

AP4 (No Added Mass) – Test F, 2.5in. Dynamic X Disp

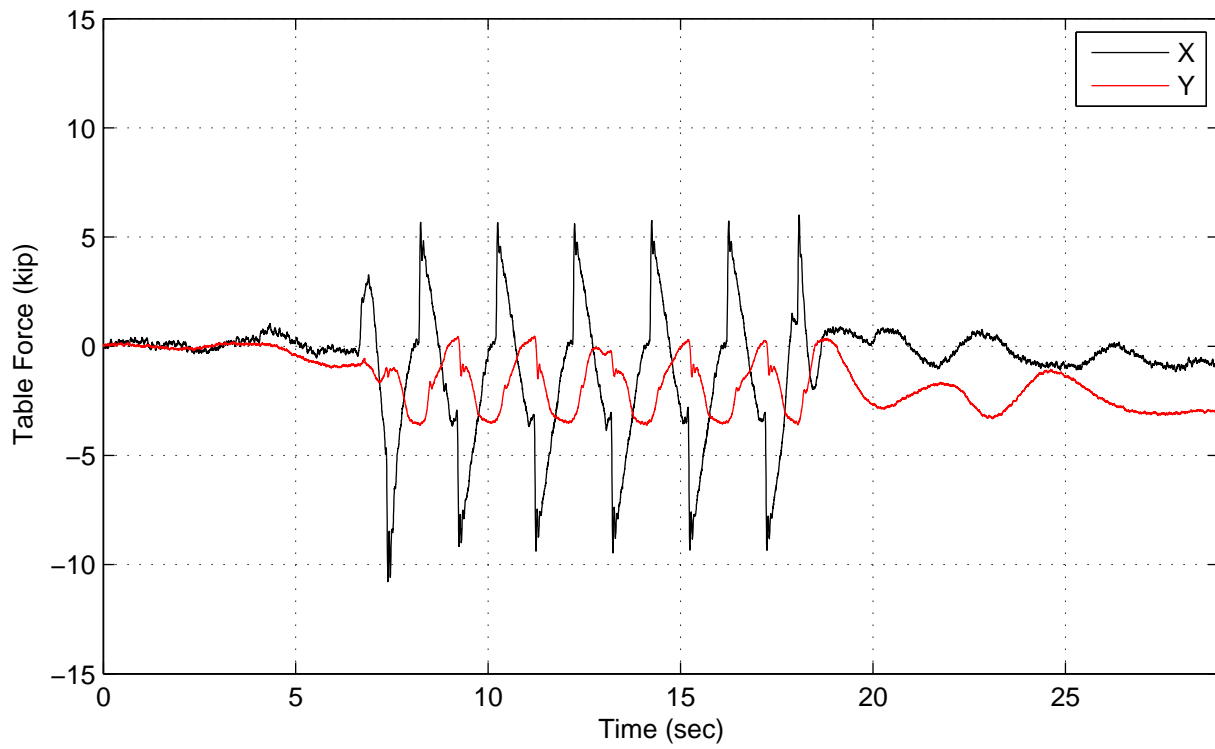
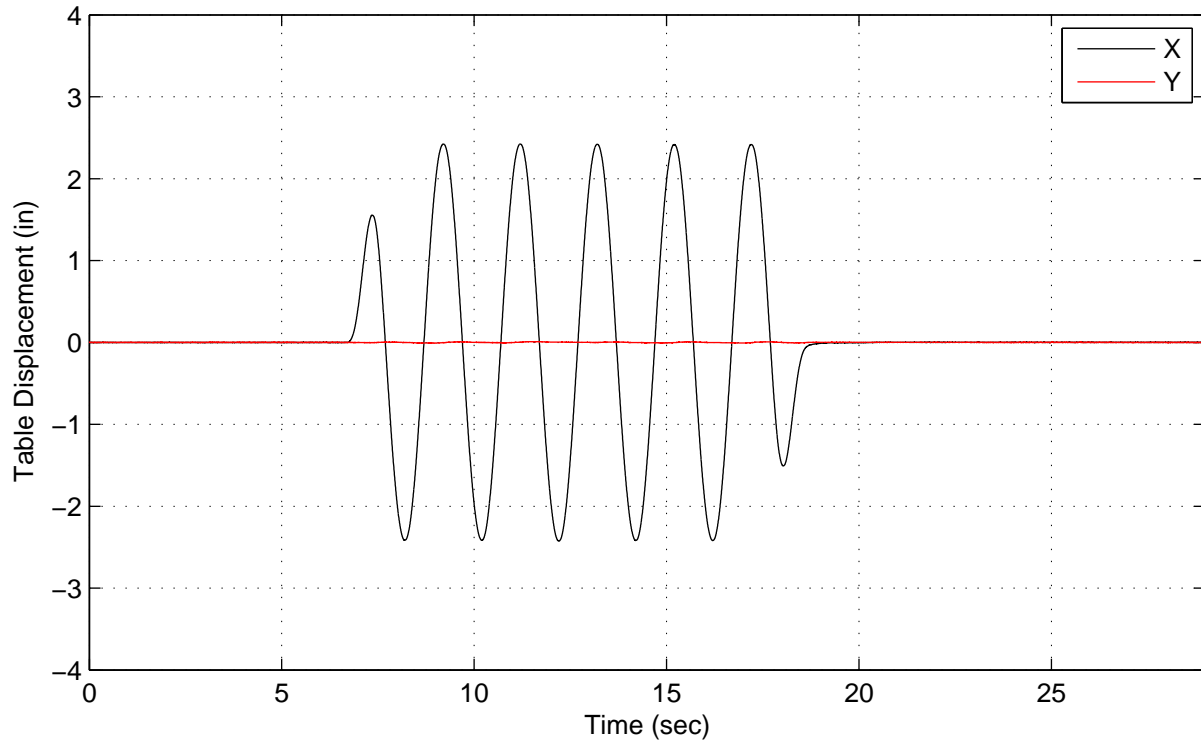

AP4 (No Added Mass) – Test F, 2.5in. Dynamic X Disp

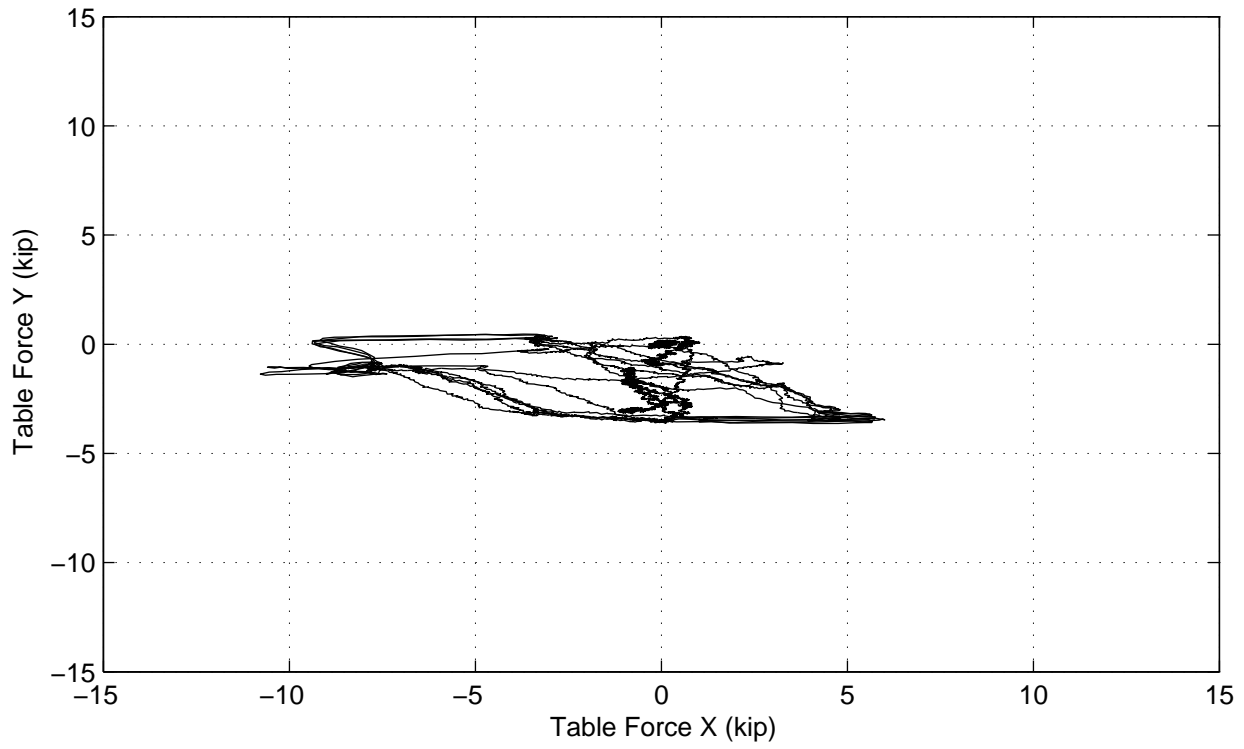
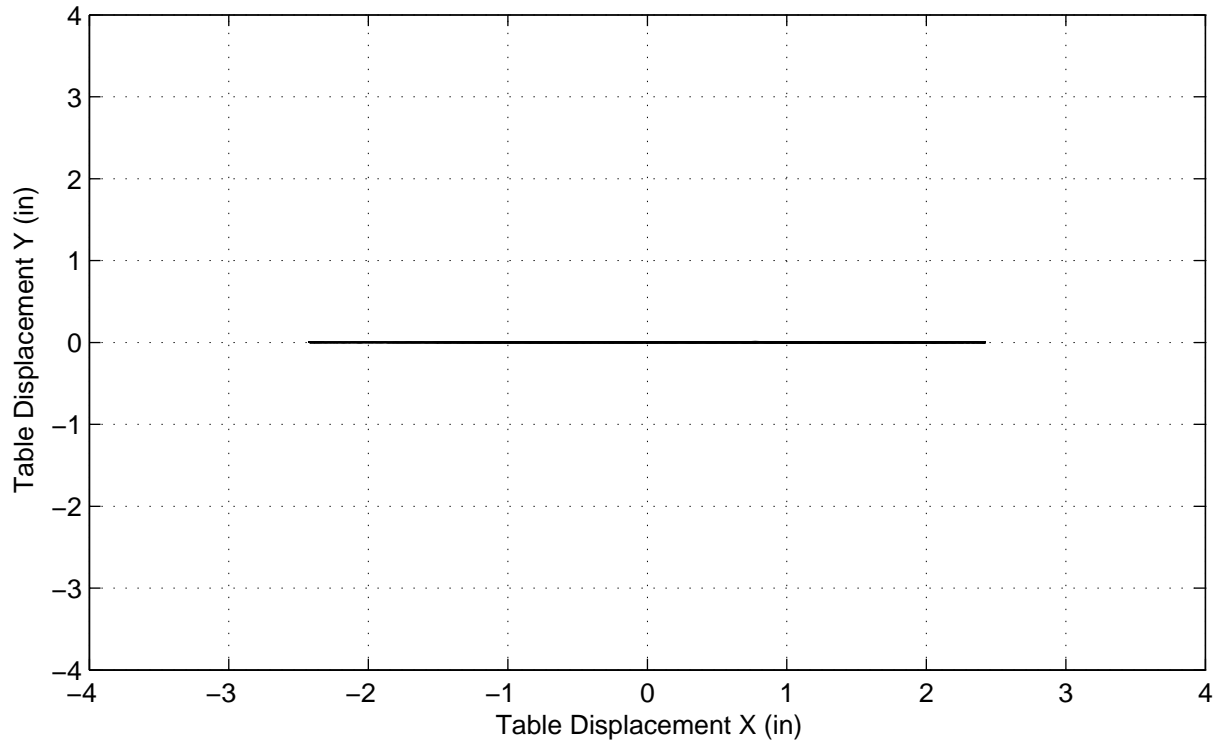

AP4 (No Added Mass) – Test F, 2.5in. Dynamic X Disp

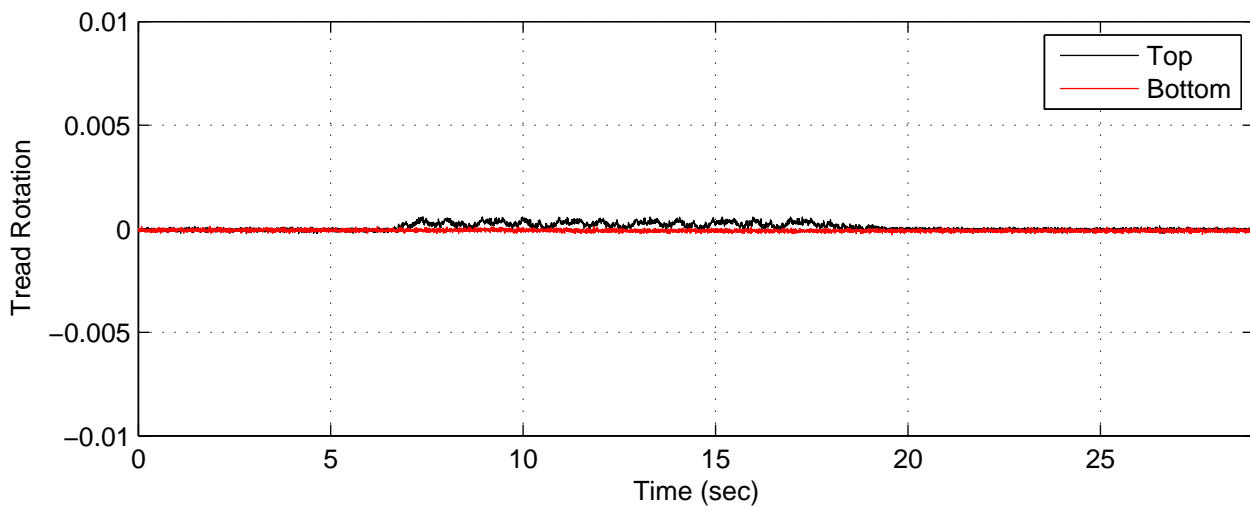
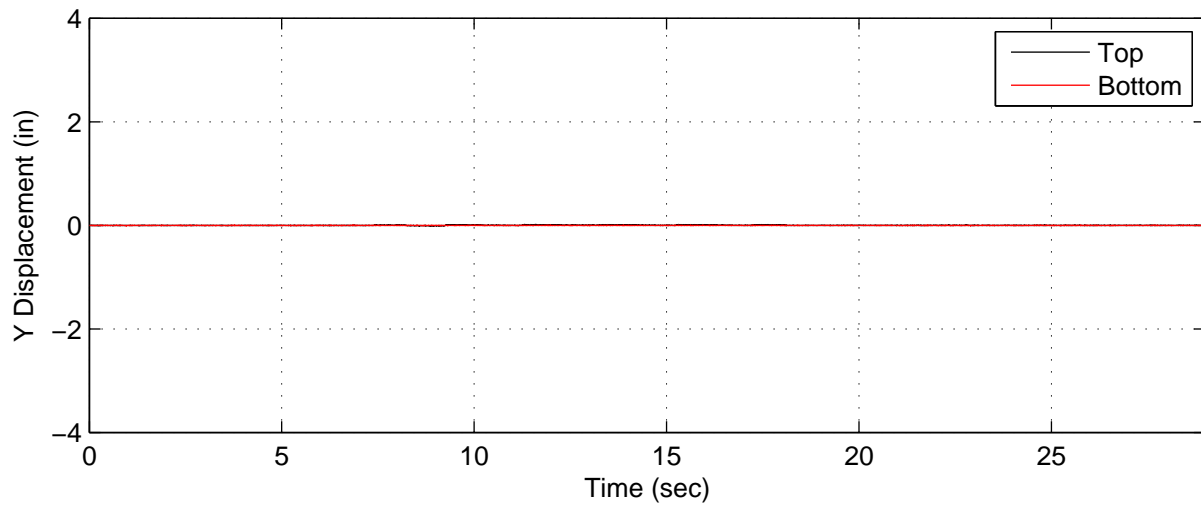
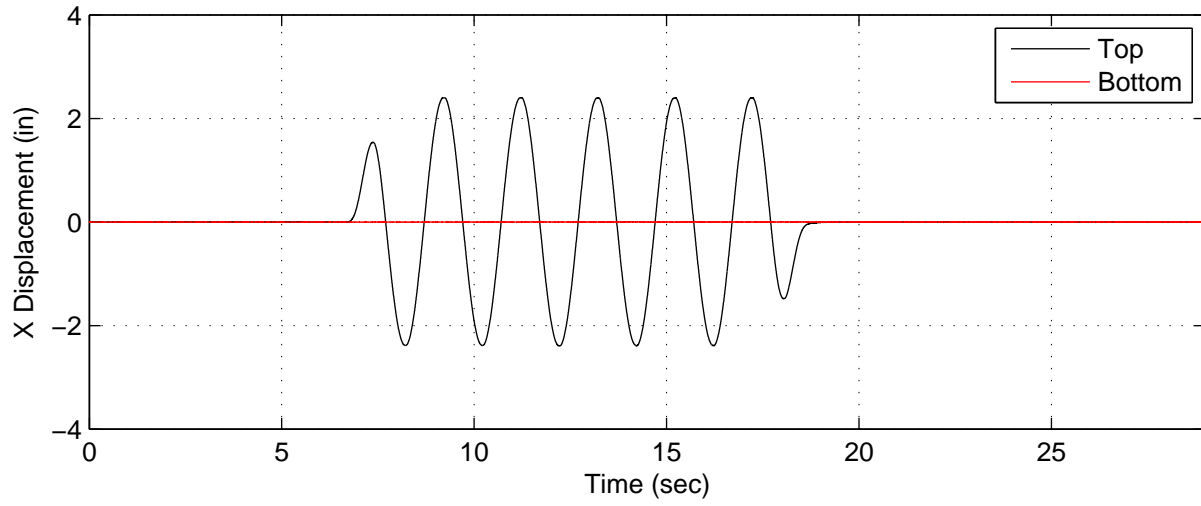

AP4 (No Added Mass) – Test F, 2.5in. Dynamic X Disp

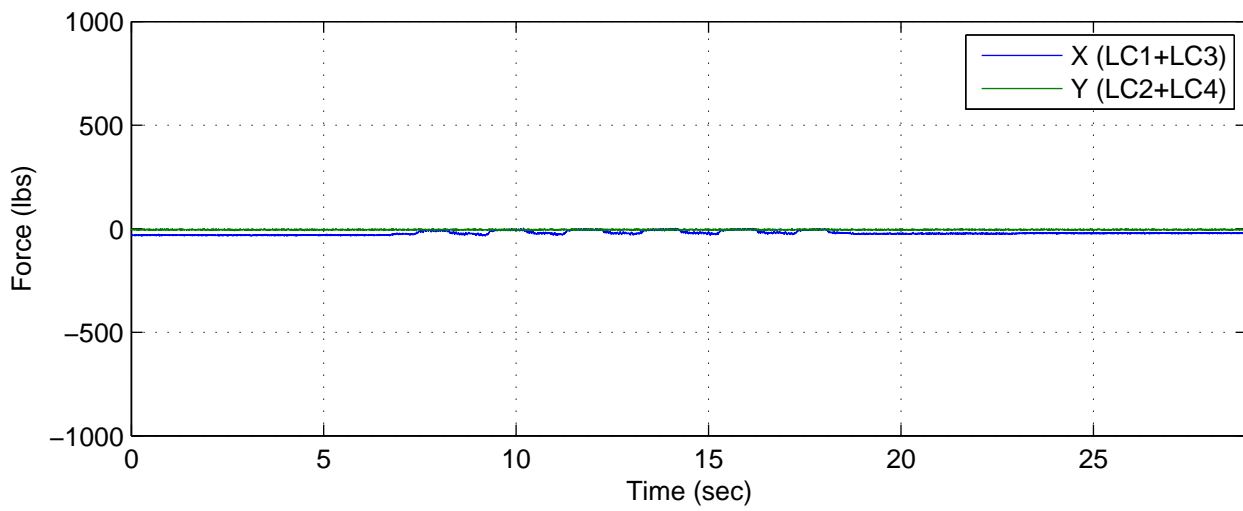
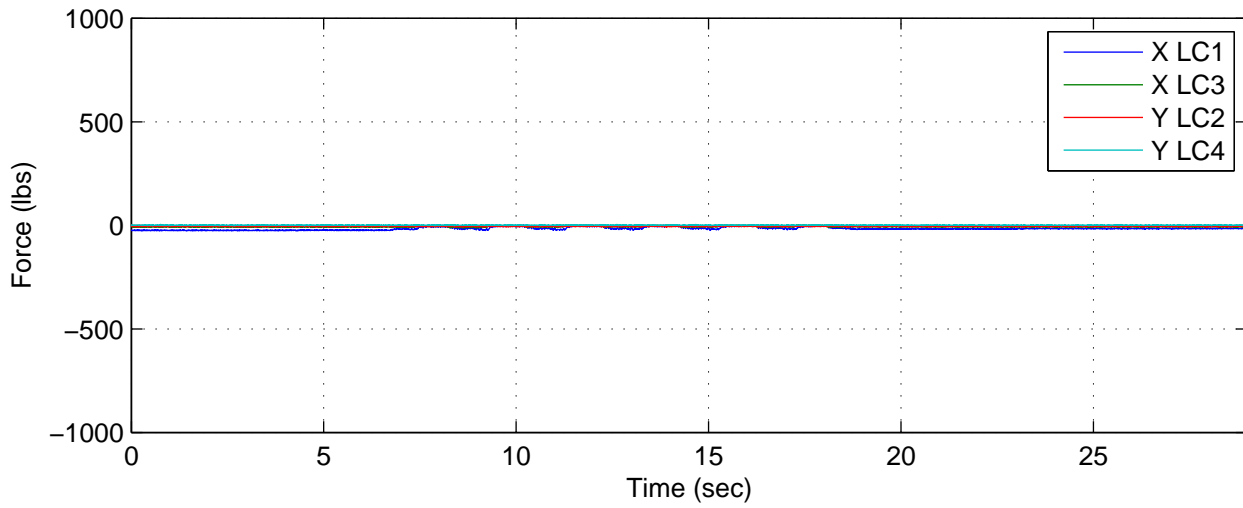
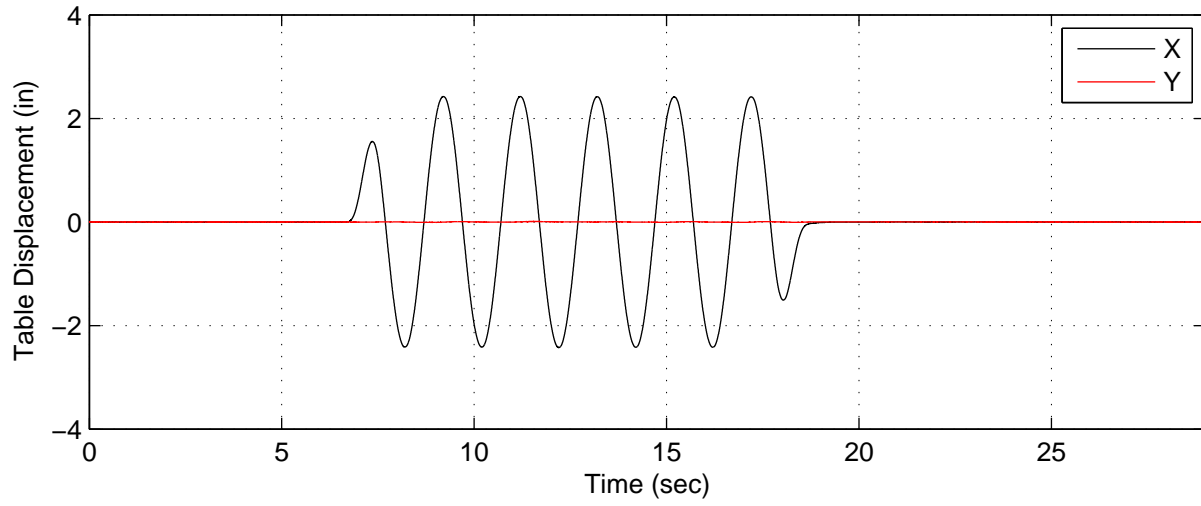

AP4 (No Added Mass) – Test F, 2.5in. Dynamic X Disp

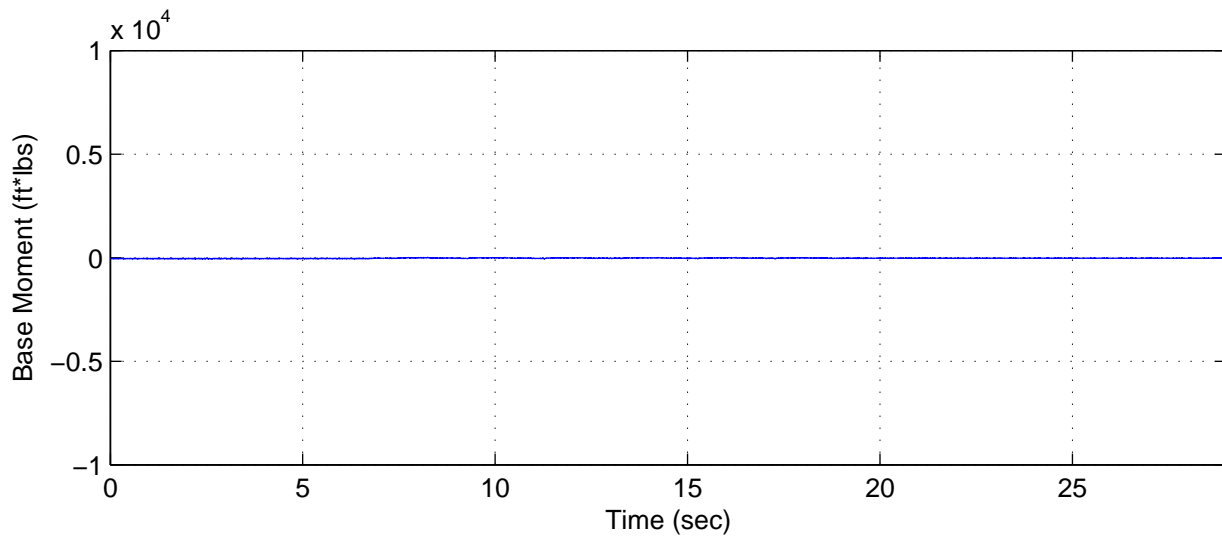
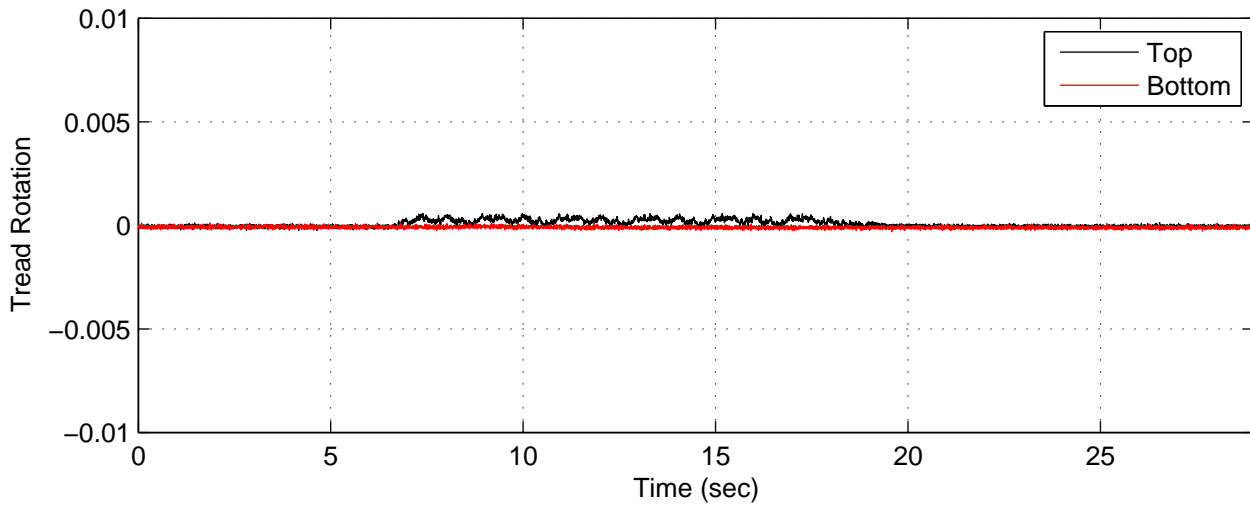
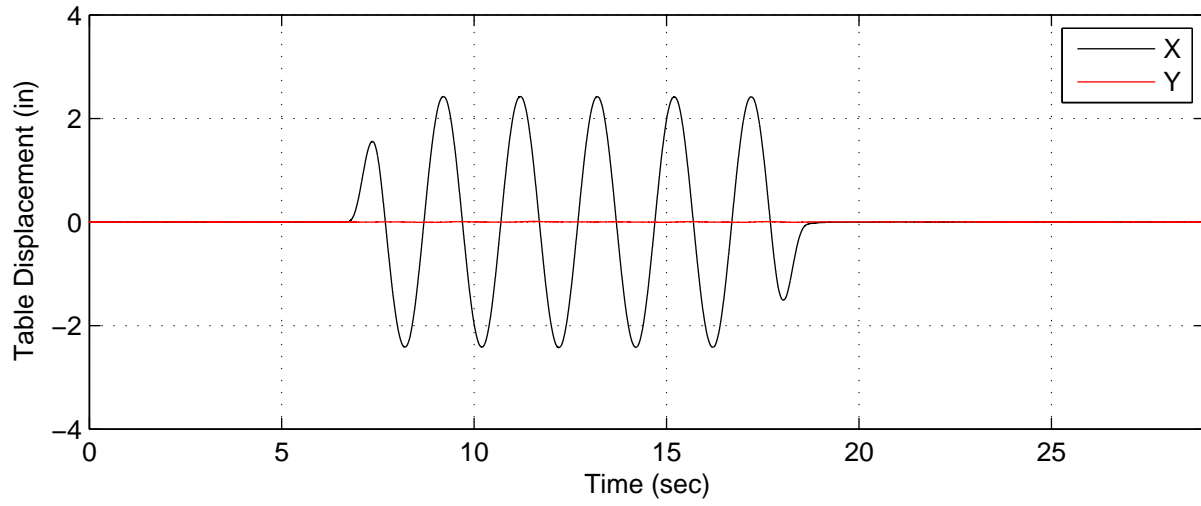

AP4 (No Added Mass) – Test G, 0.5in. Dynamic Y Disp

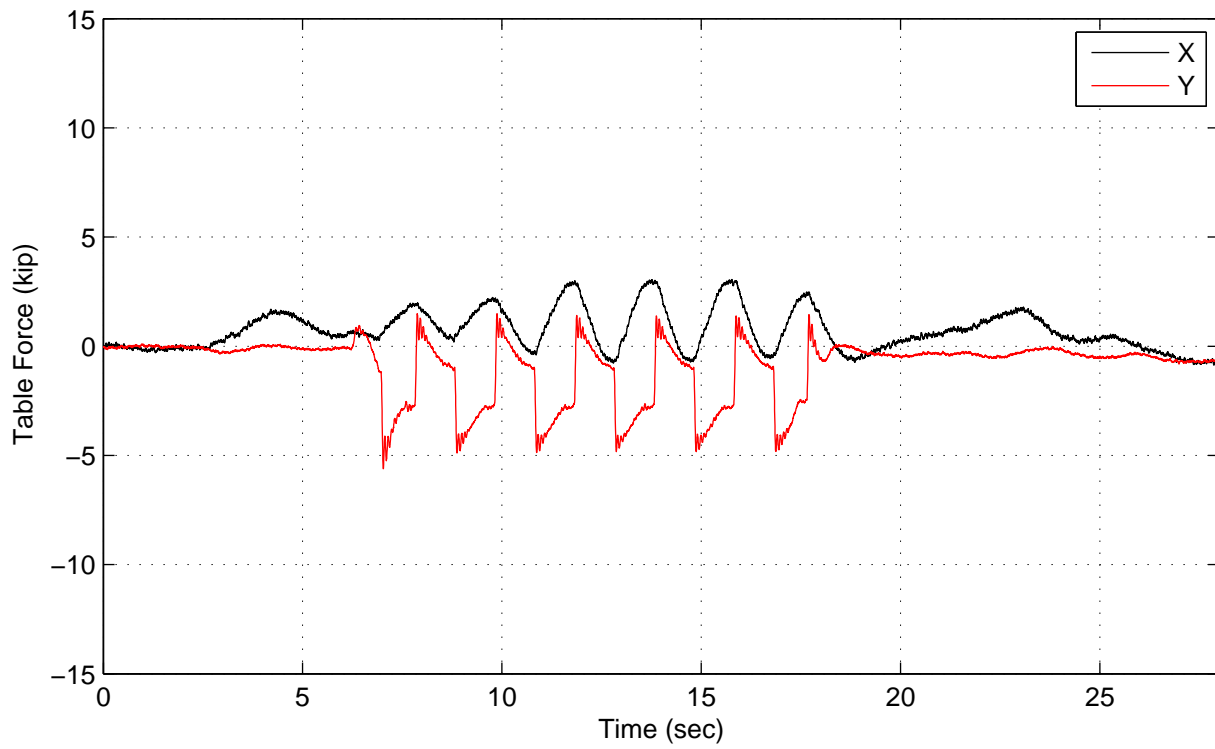
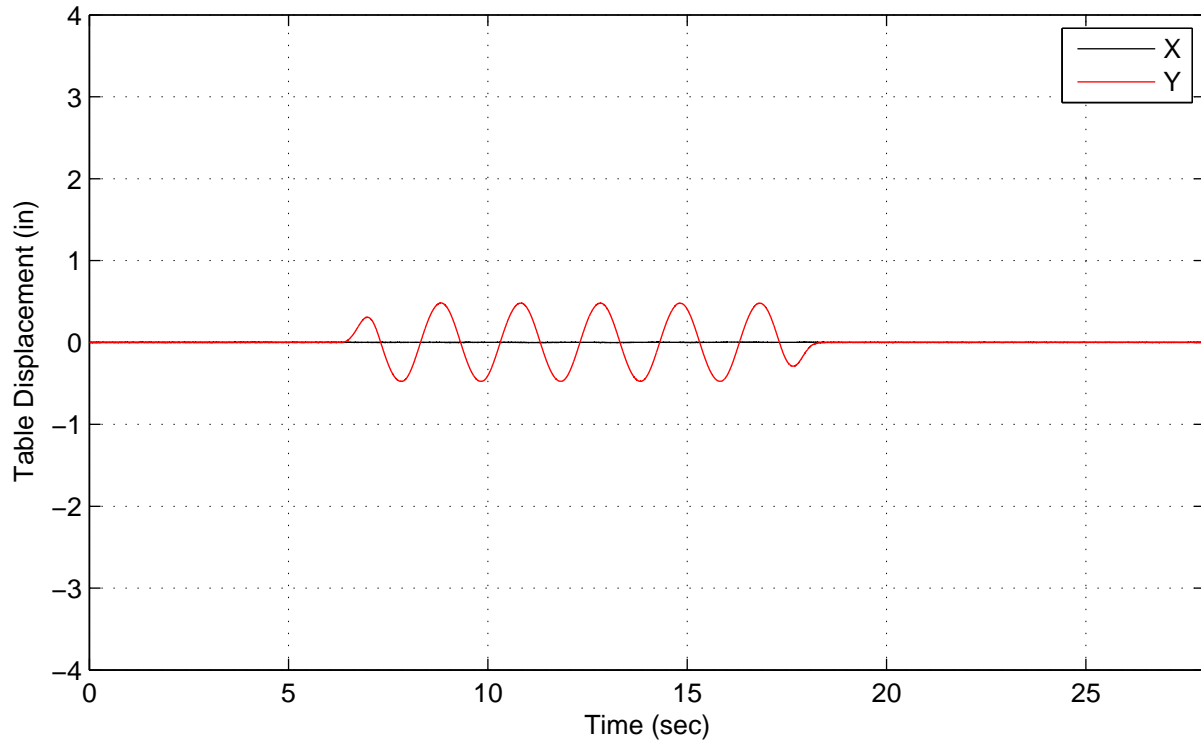

AP4 (No Added Mass) – Test G, 0.5in. Dynamic Y Disp

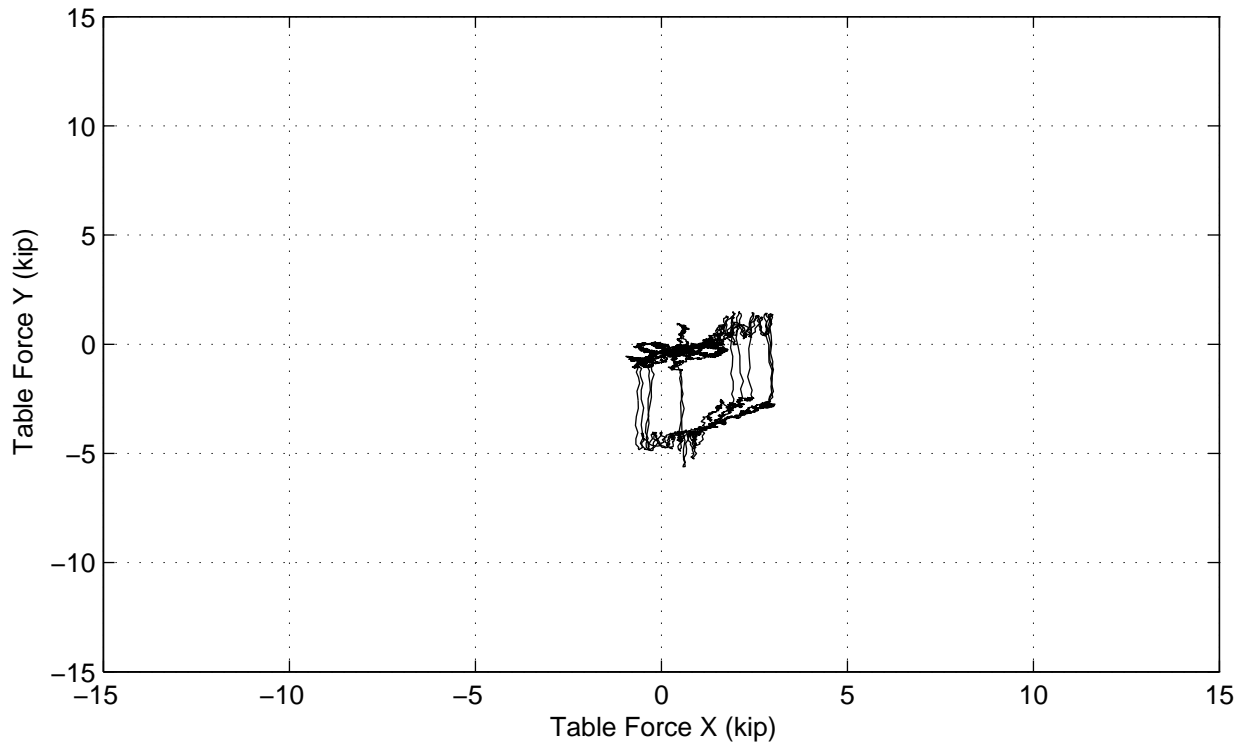
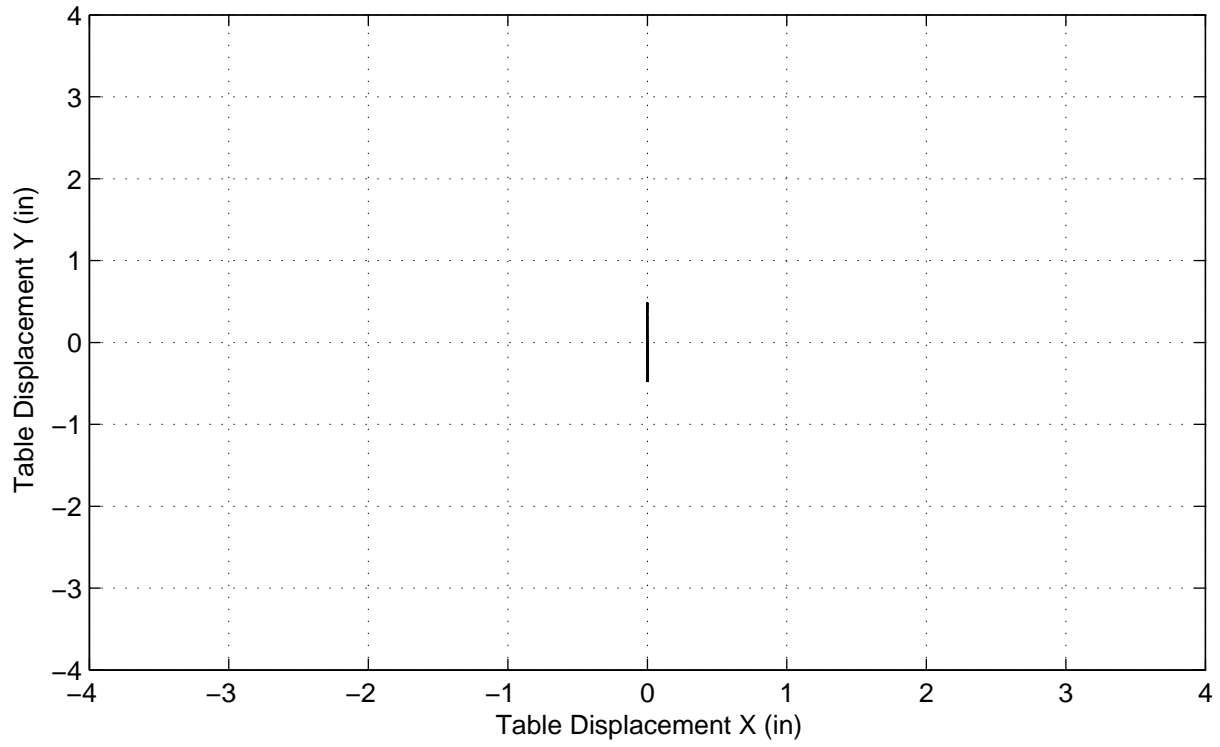



AP4 (No Added Mass) – Test G, 0.5in. Dynamic Y Disp

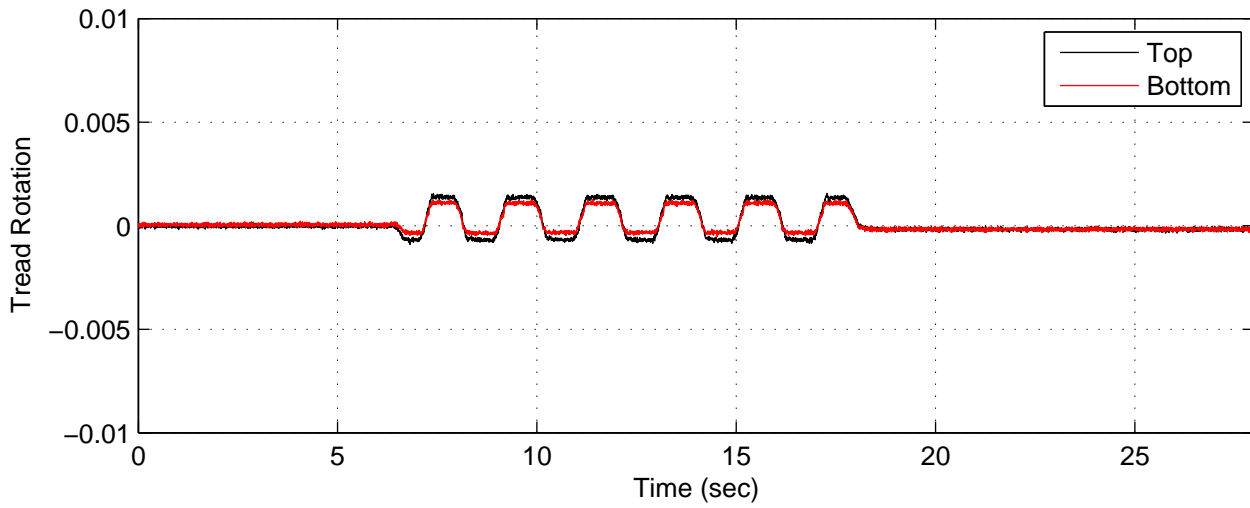
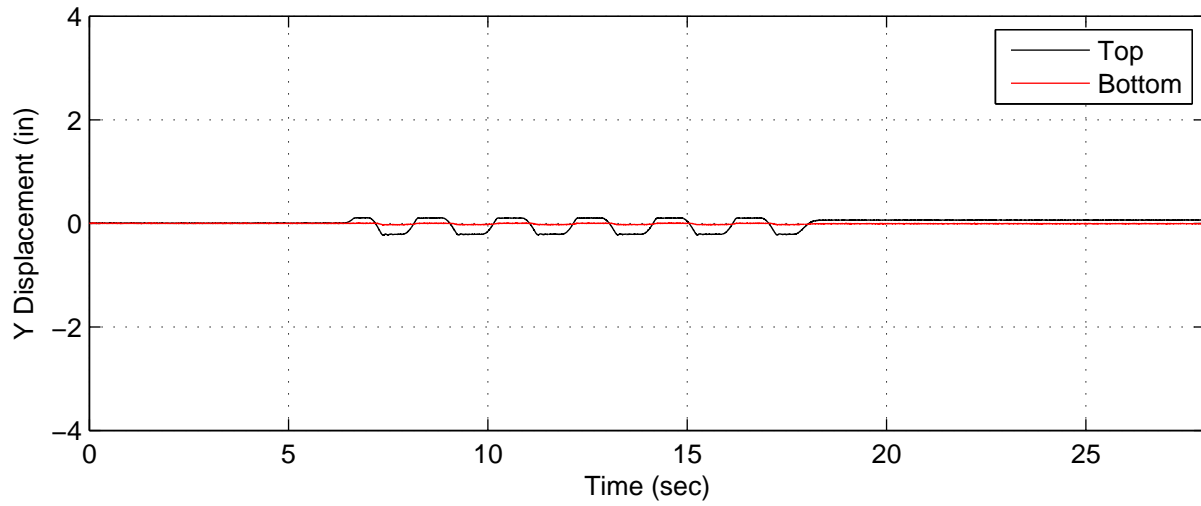
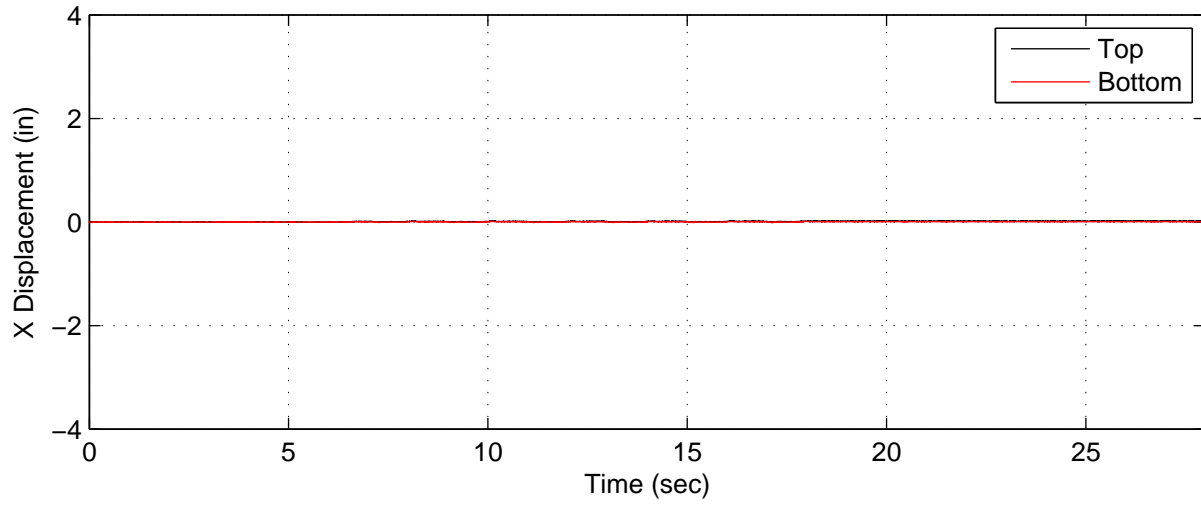

AP4 (No Added Mass) – Test G, 0.5in. Dynamic Y Disp

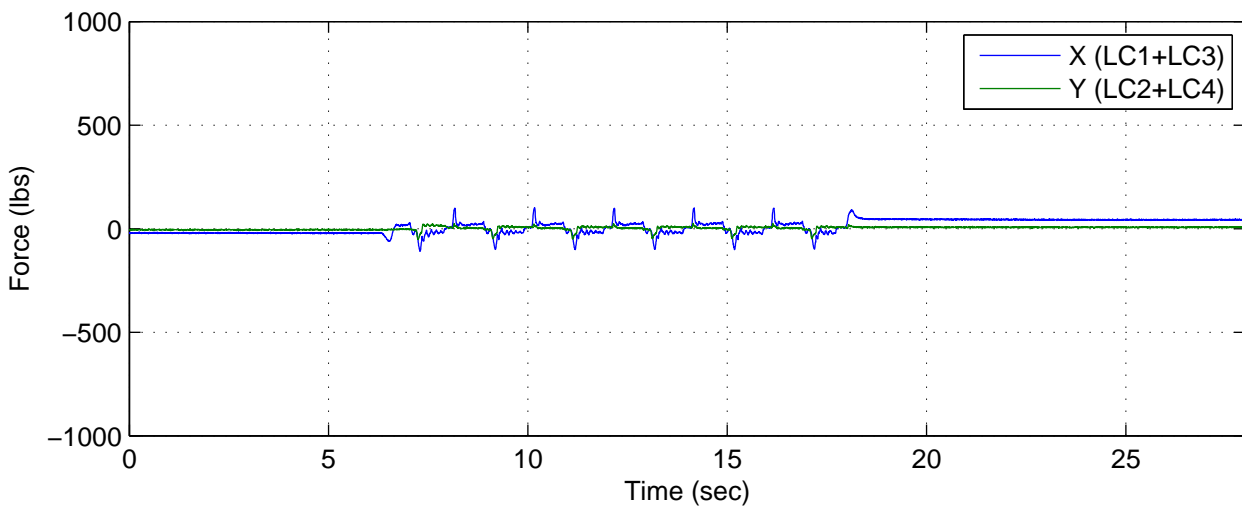
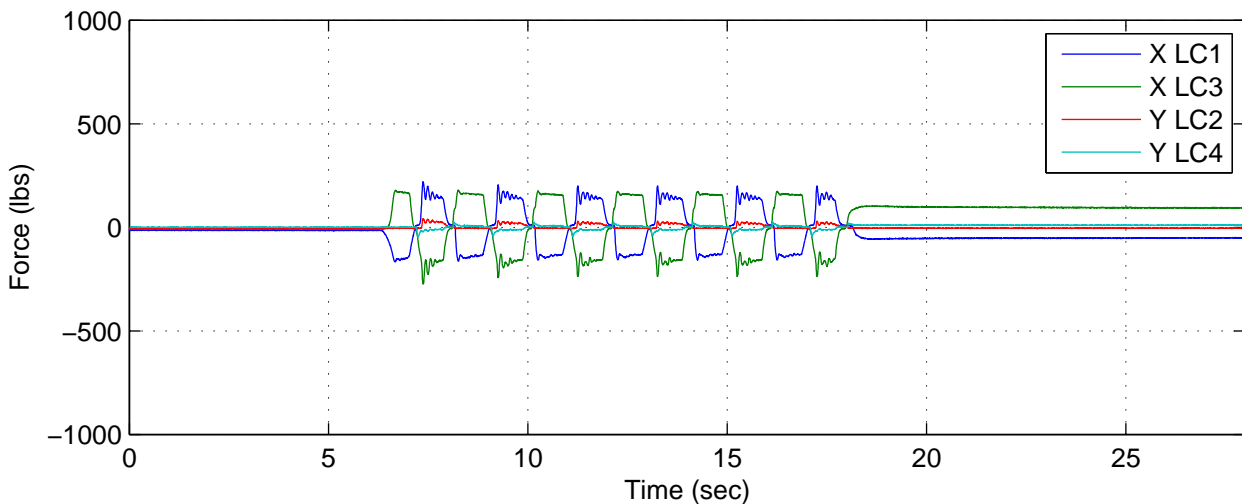
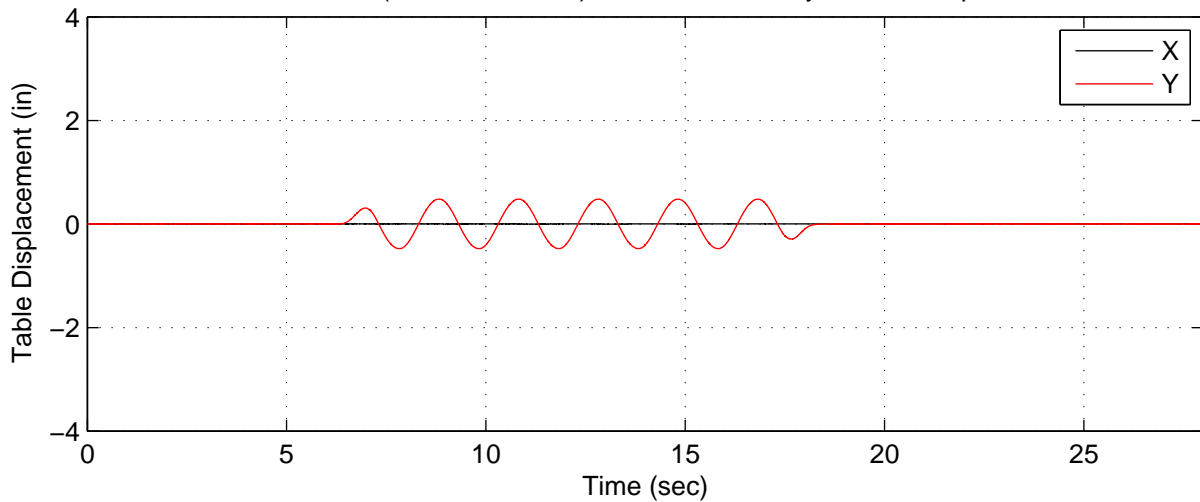

AP4 (No Added Mass) – Test G, 0.5in. Dynamic Y Disp

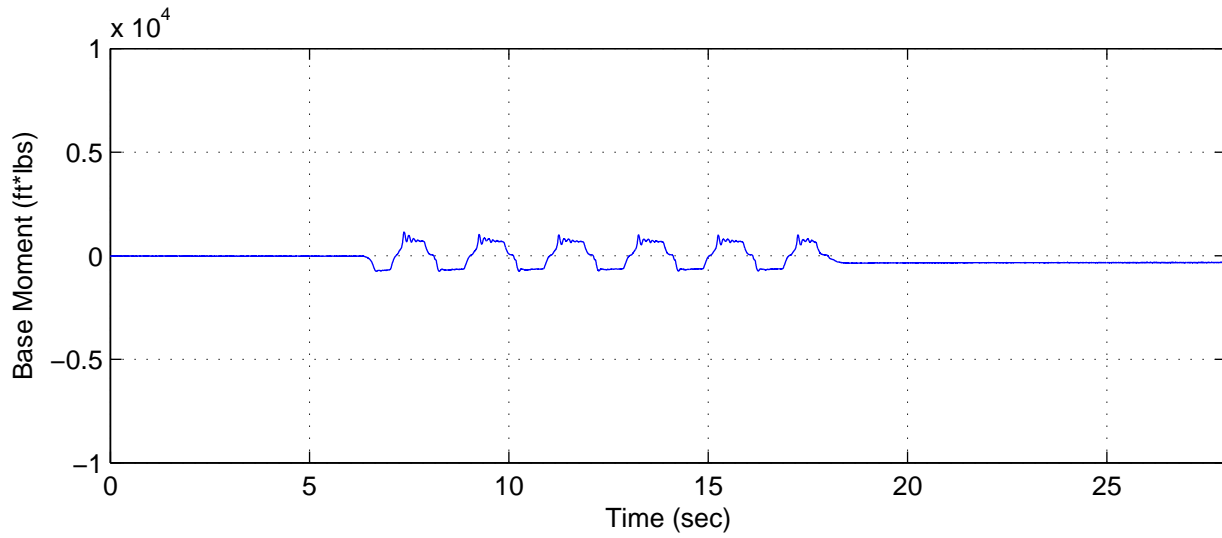
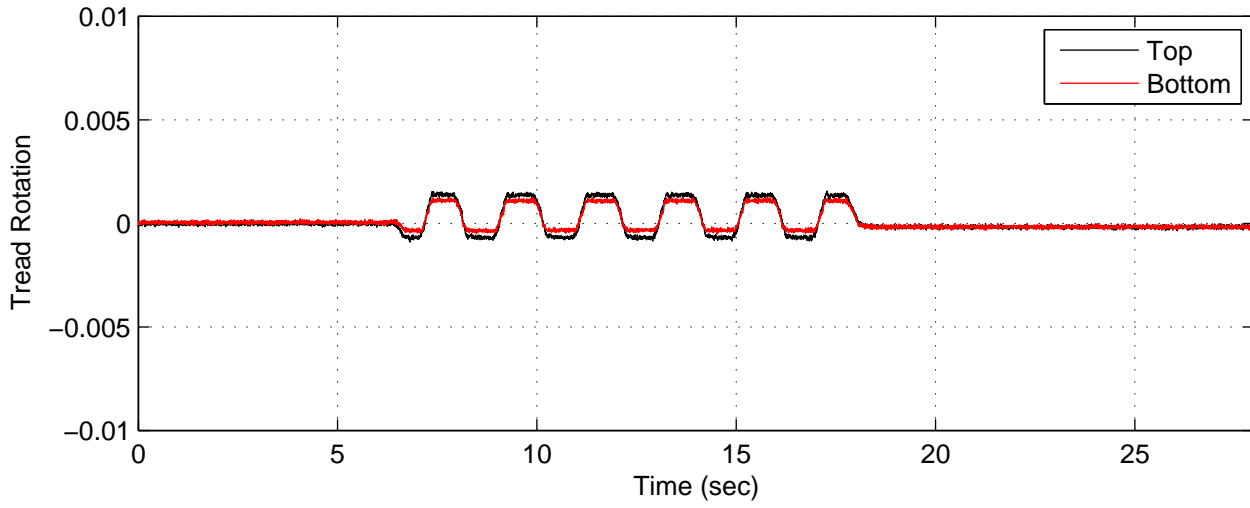
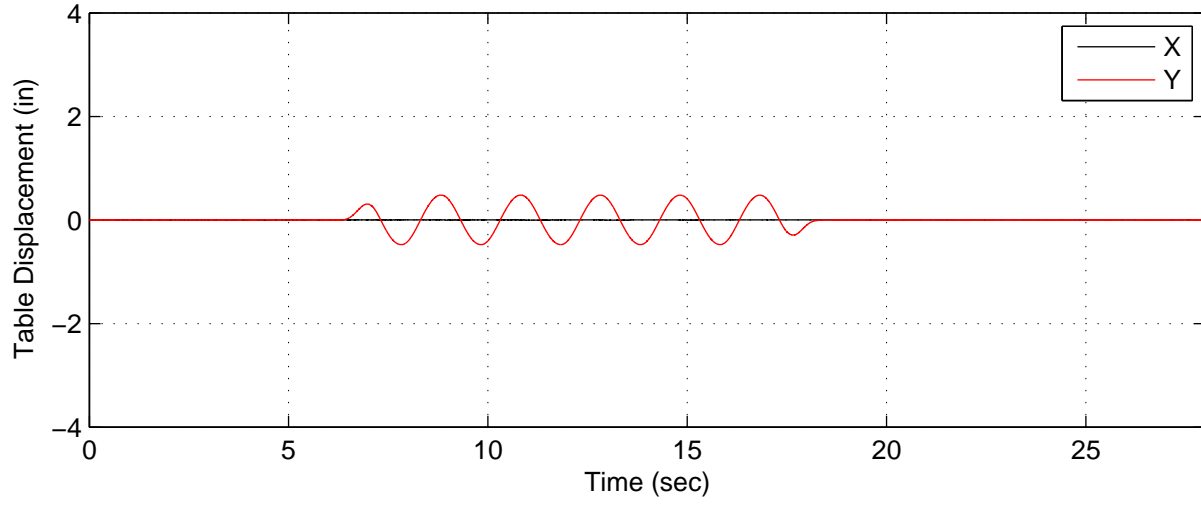

AP4 (No Added Mass) – Test H, 2.5in. Dynamic Y Disp

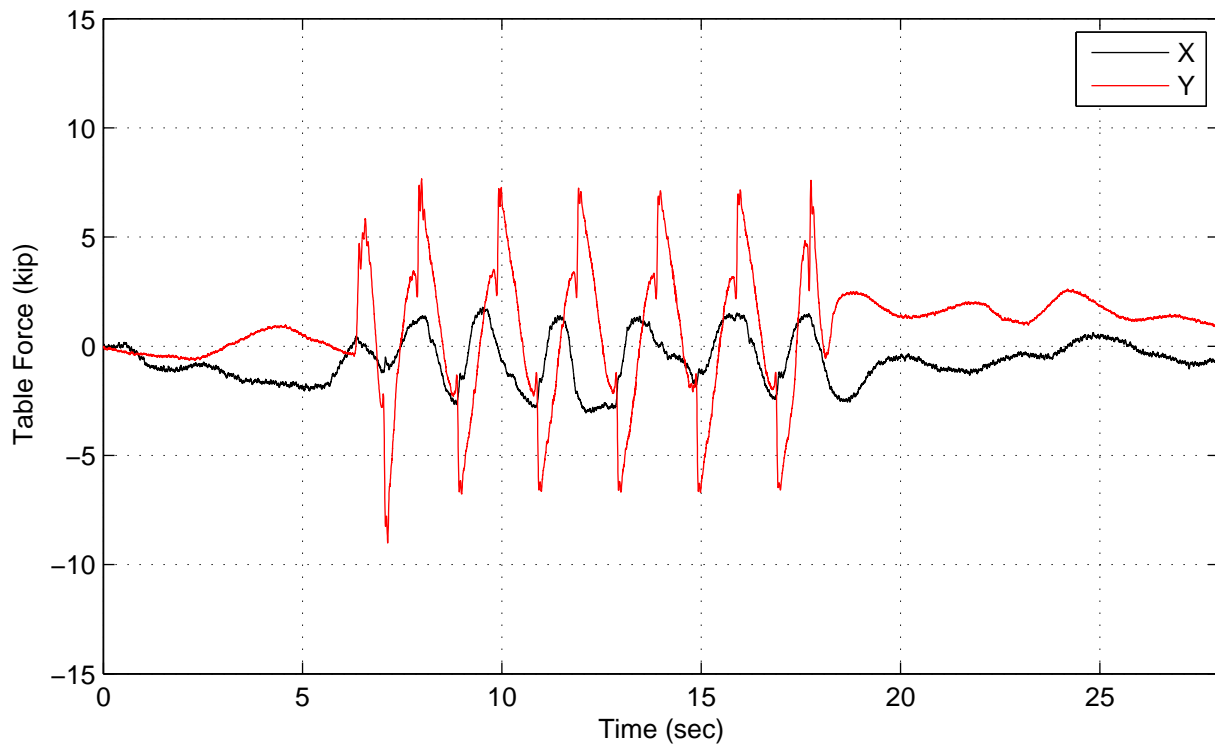
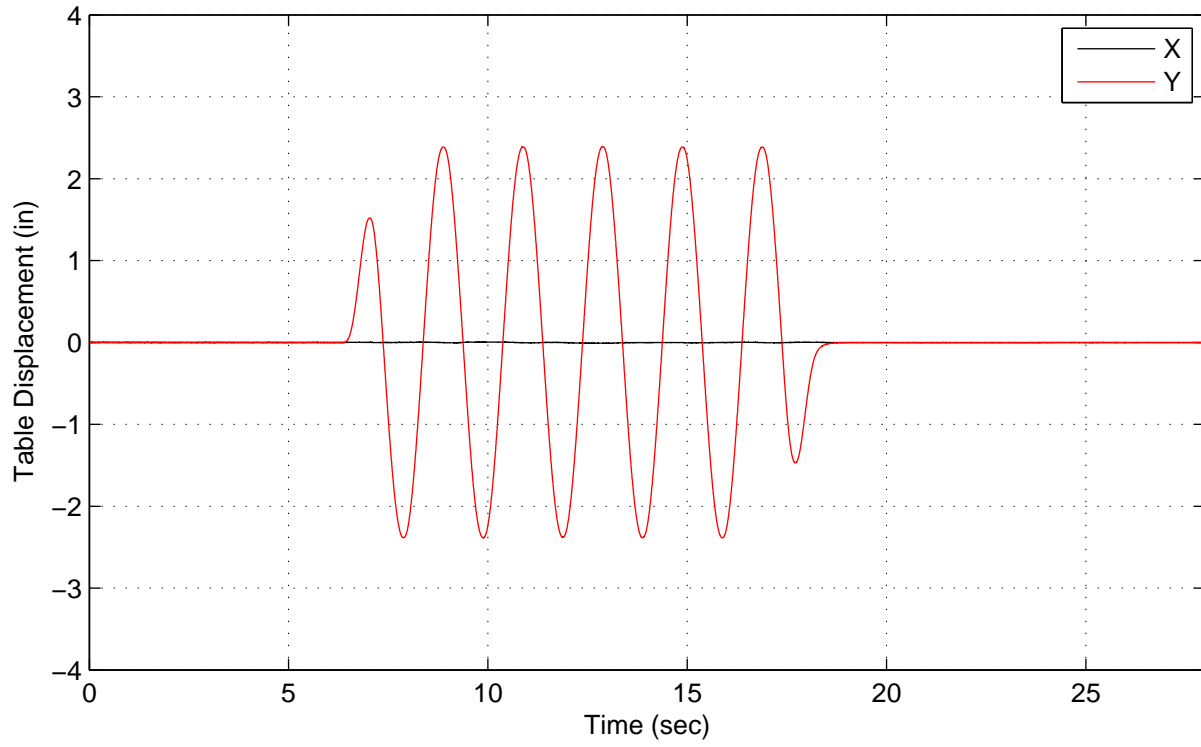

AP4 (No Added Mass) – Test H, 2.5in. Dynamic Y Disp

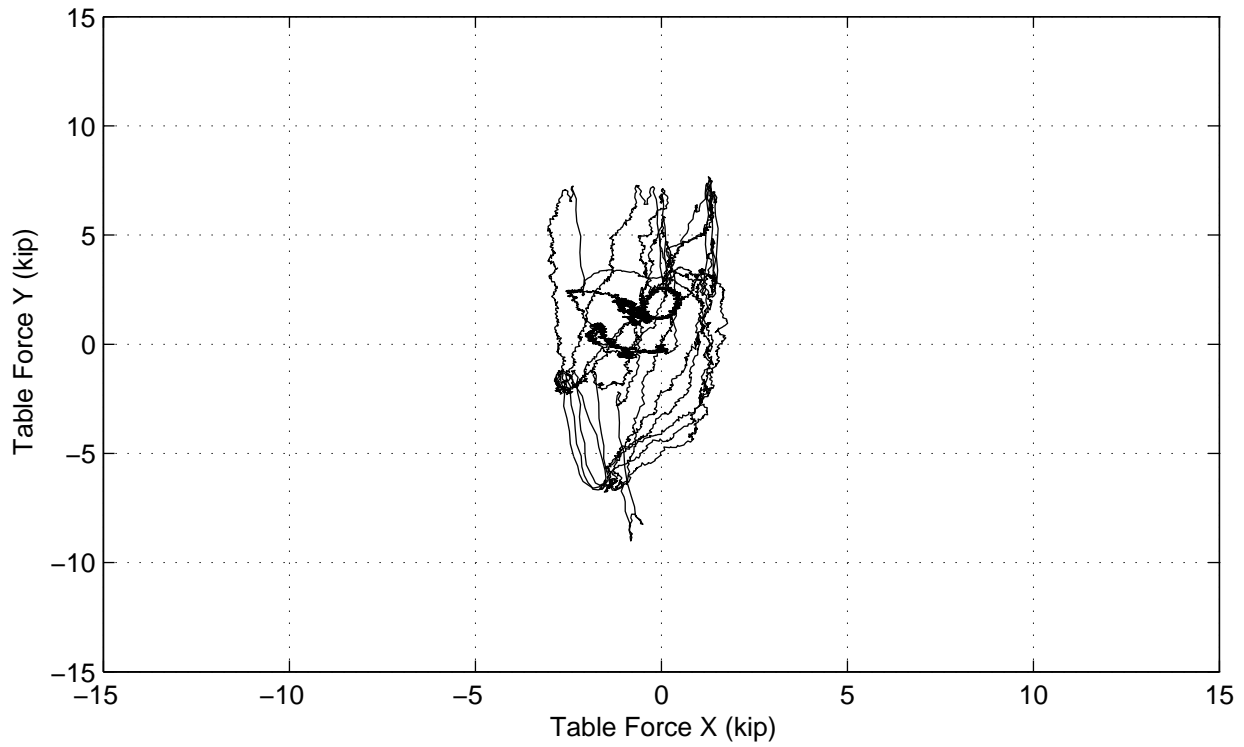
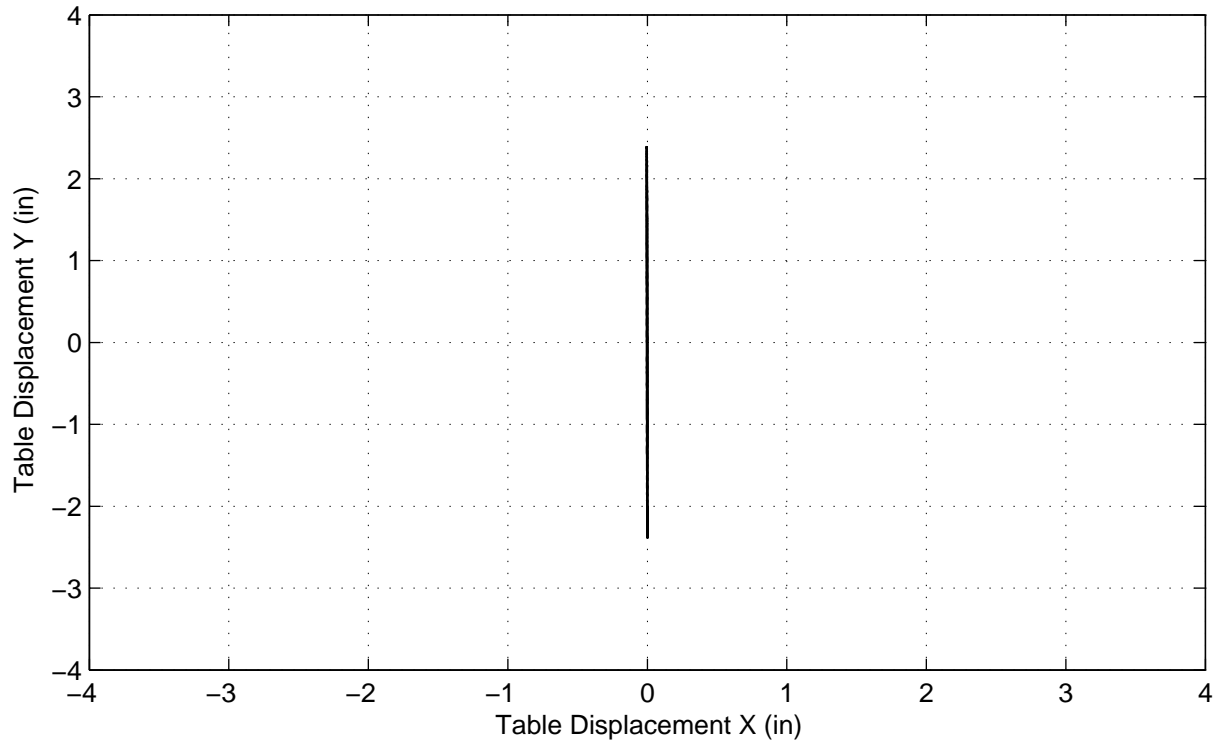

AP4 (No Added Mass) – Test H, 2.5in. Dynamic Y Disp

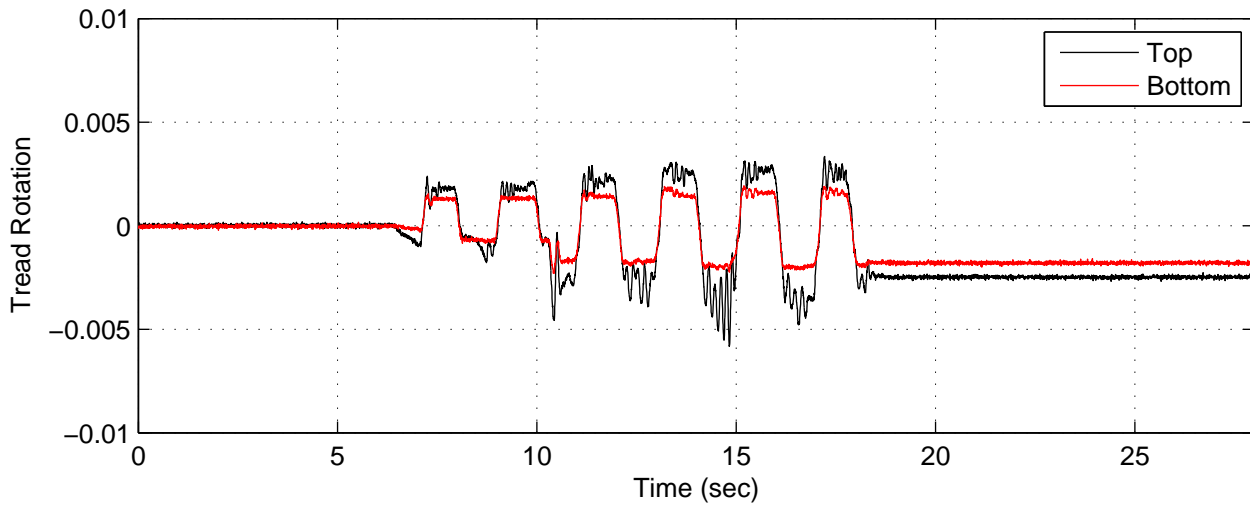
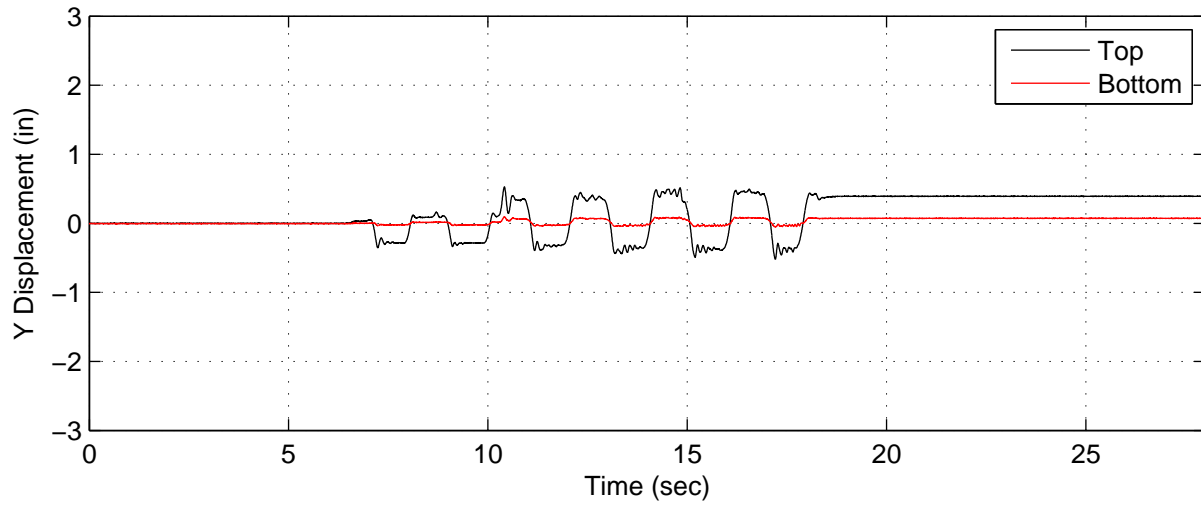
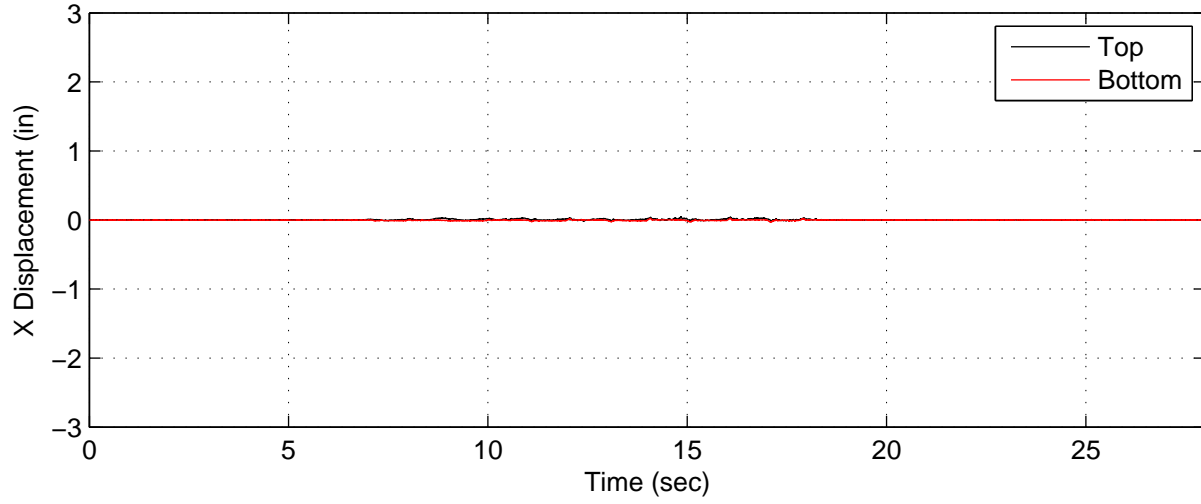

AP4 (No Added Mass) – Test H, 2.5in. Dynamic Y Disp

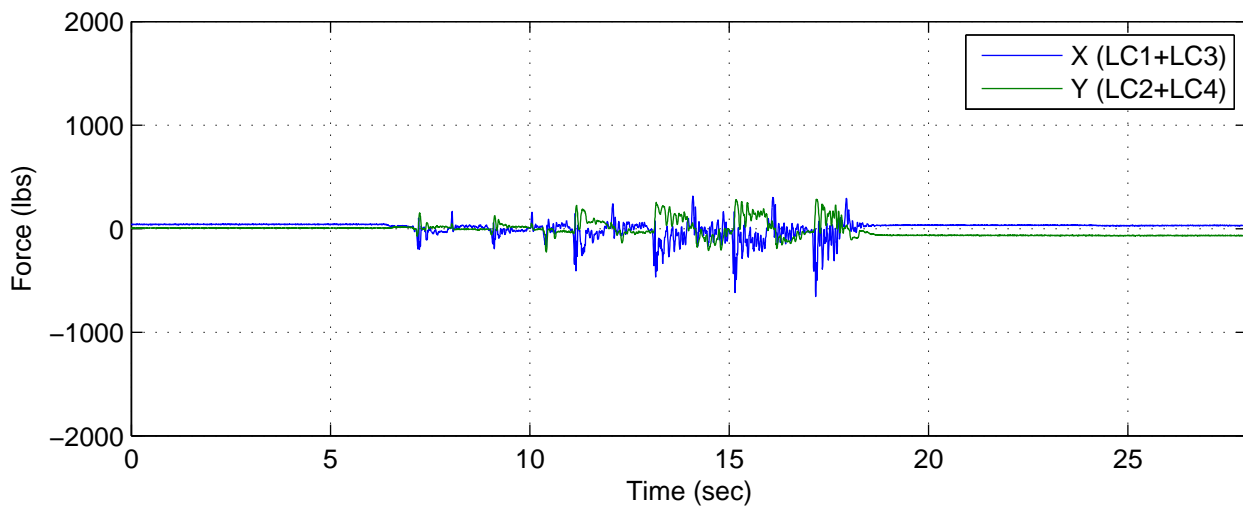
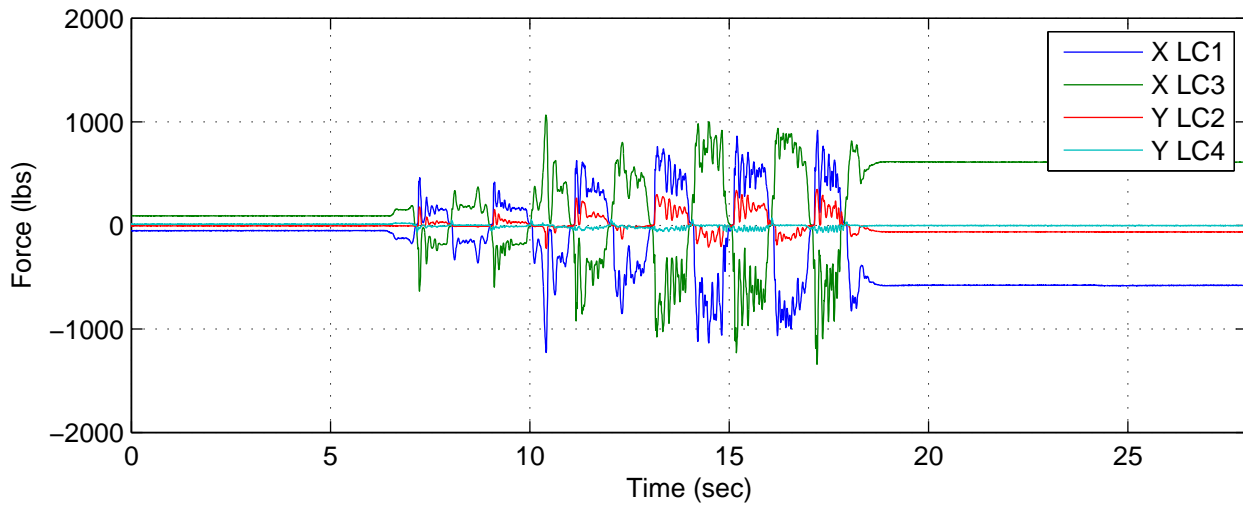
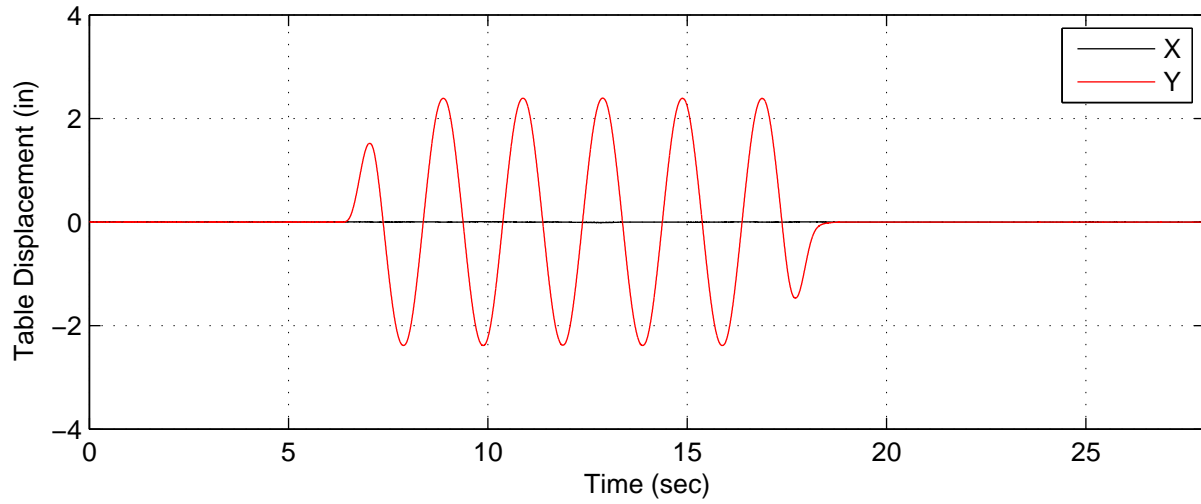

AP4 (No Added Mass) – Test H, 2.5in. Dynamic Y Disp

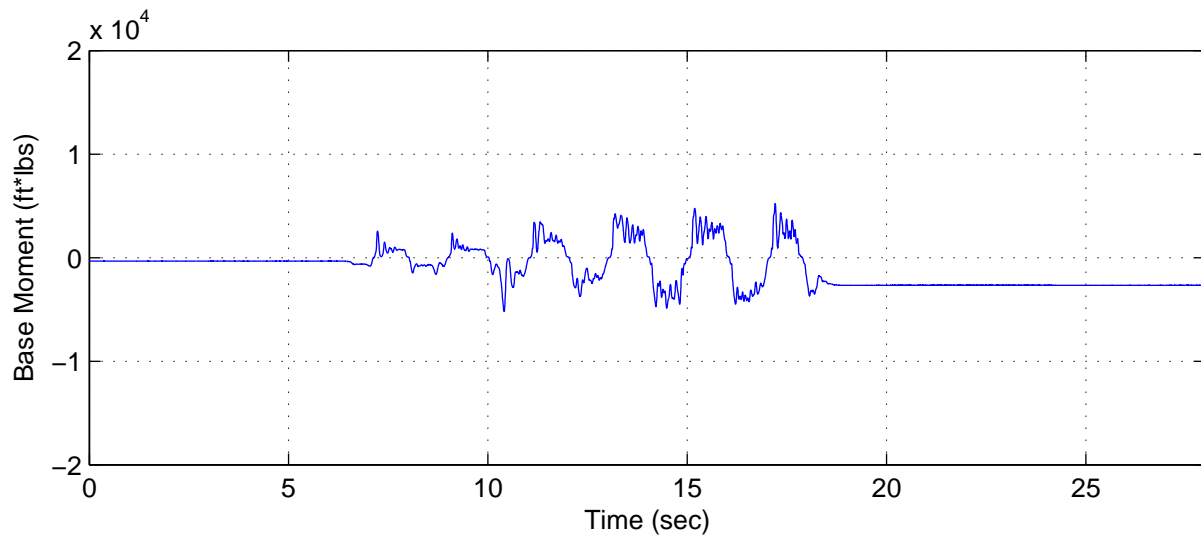
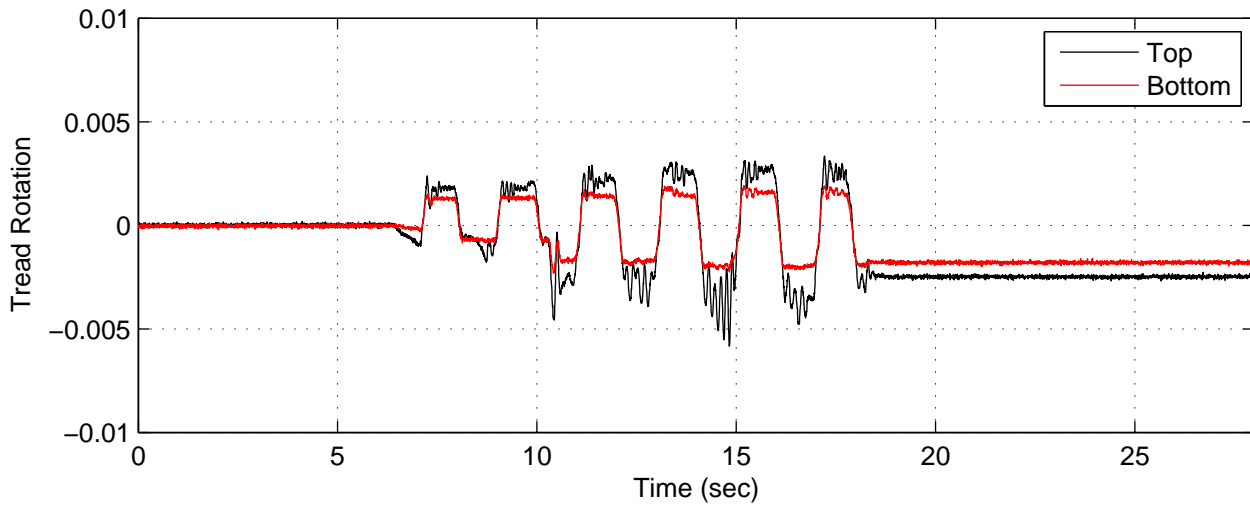
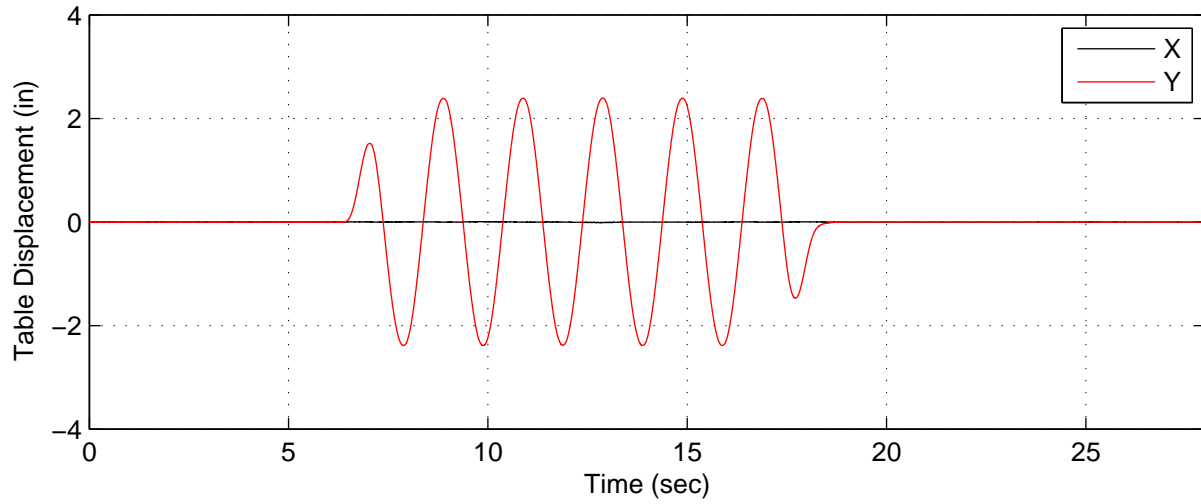



AP4 (No Added Mass) – Test I, 0.5in. Dynamic X+Y Disp

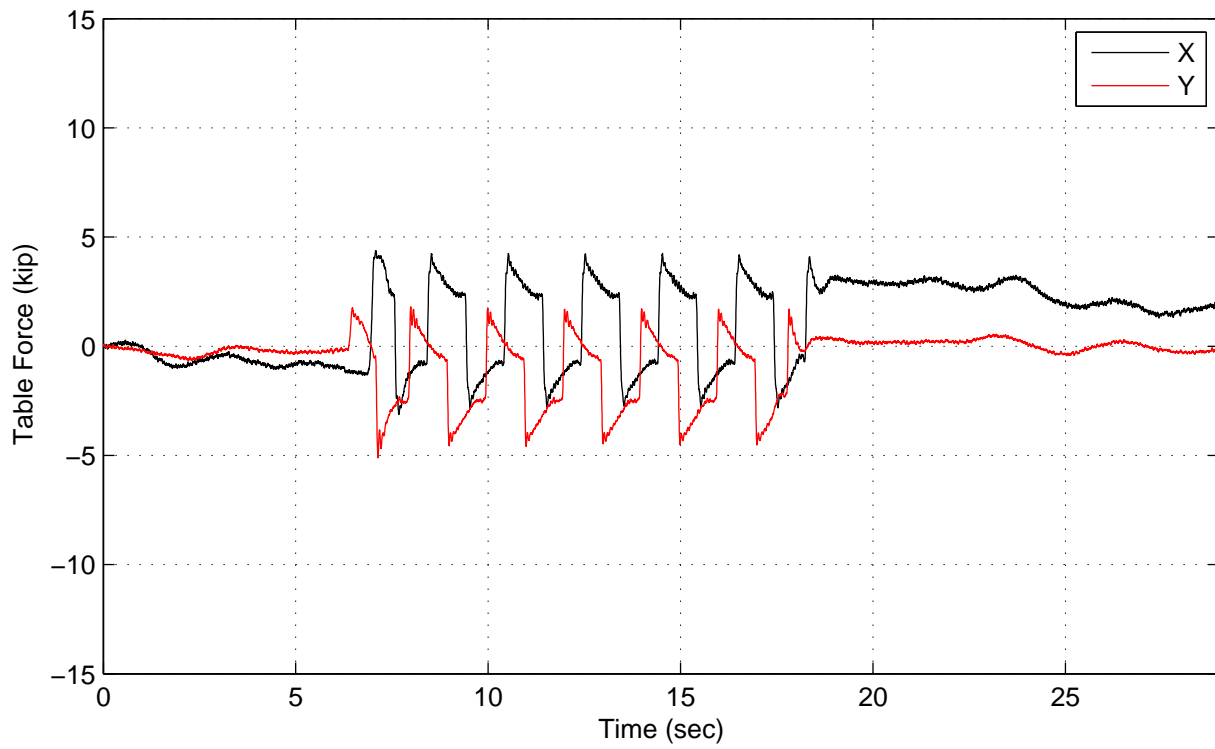
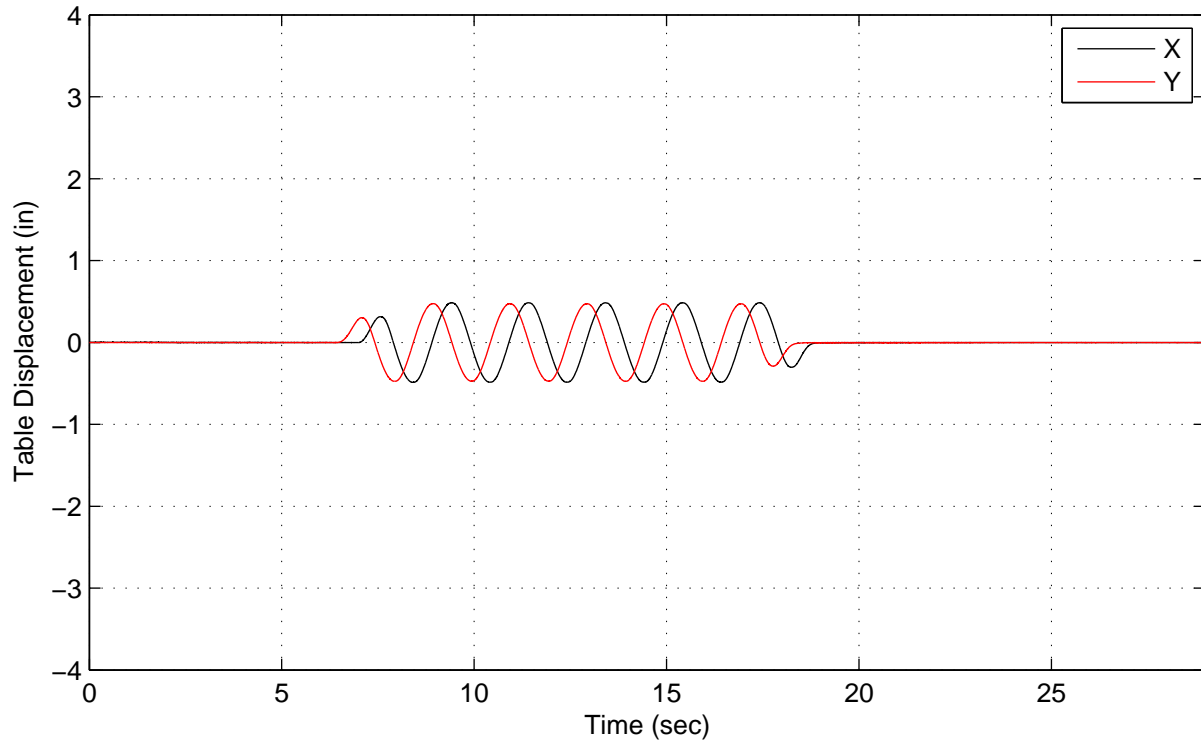

AP4 (No Added Mass) – Test I, 0.5in. Dynamic X+Y Disp

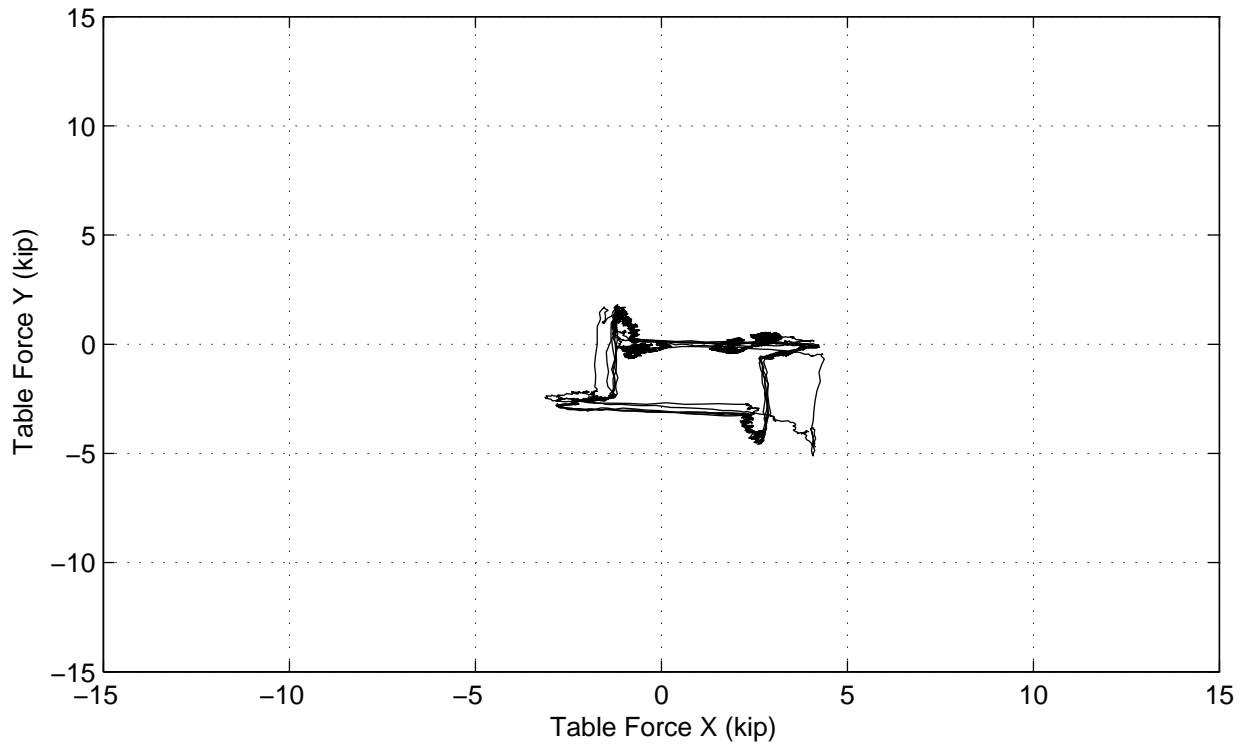
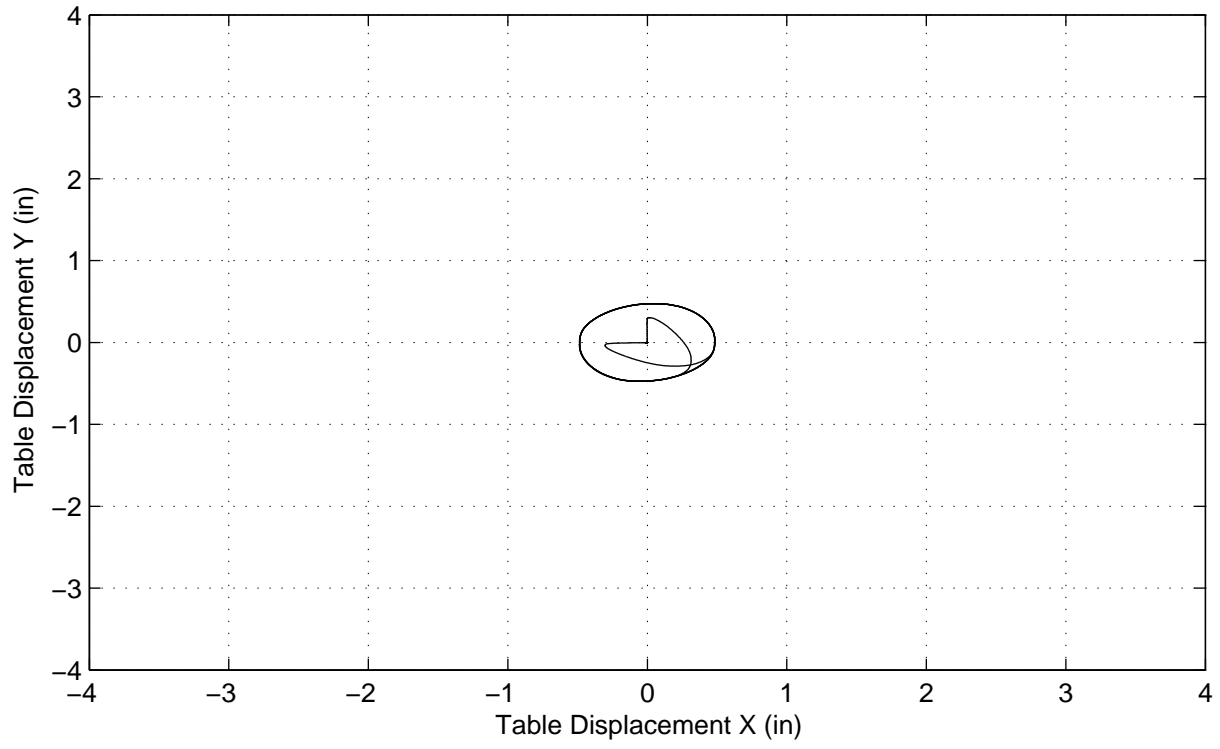

AP4 (No Added Mass) – Test I, 0.5in. Dynamic X+Y Disp

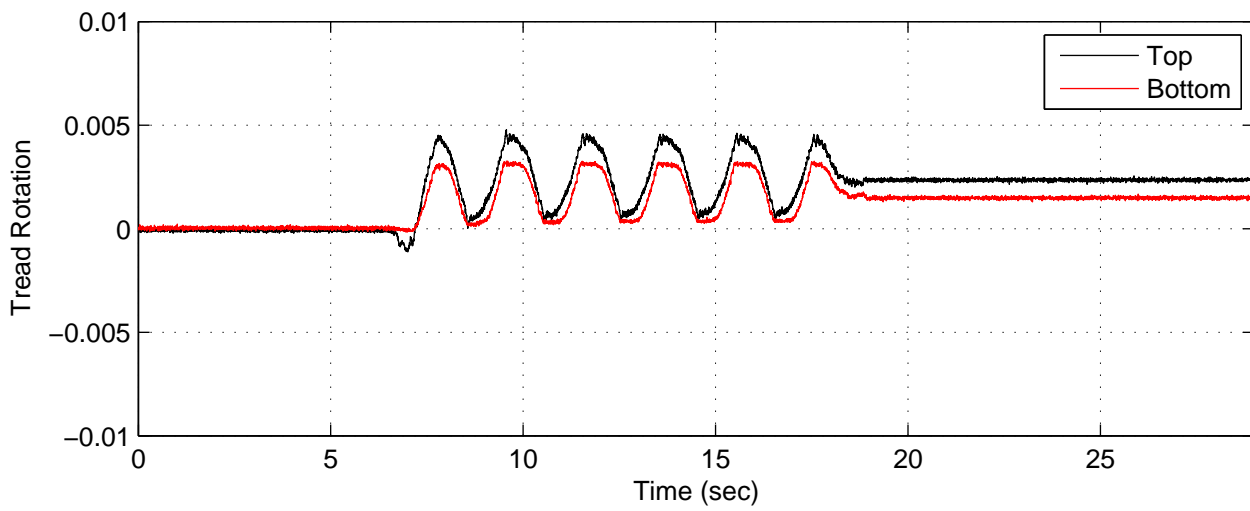
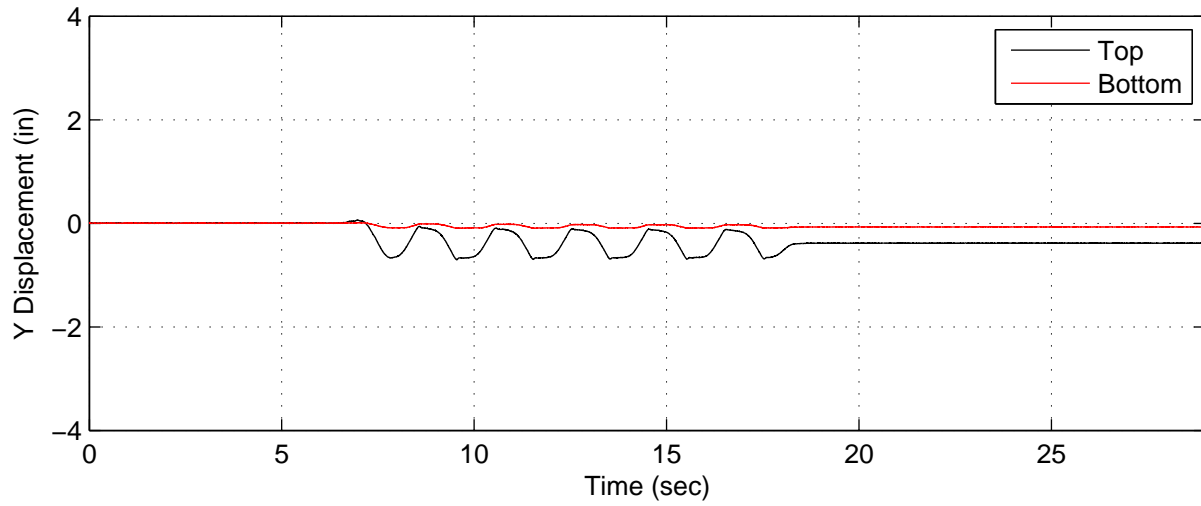
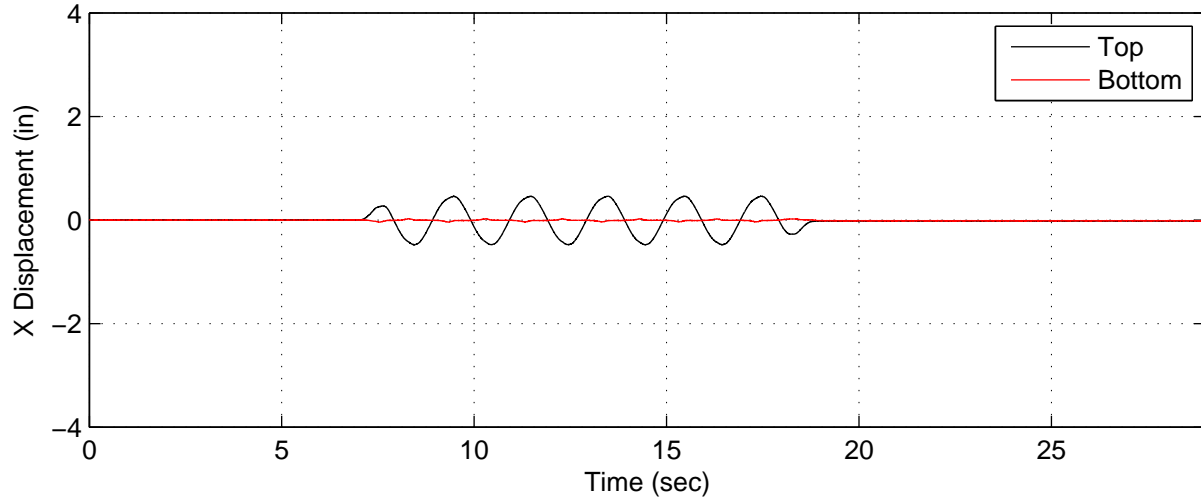

AP4 (No Added Mass) – Test I, 0.5in. Dynamic X+Y Disp

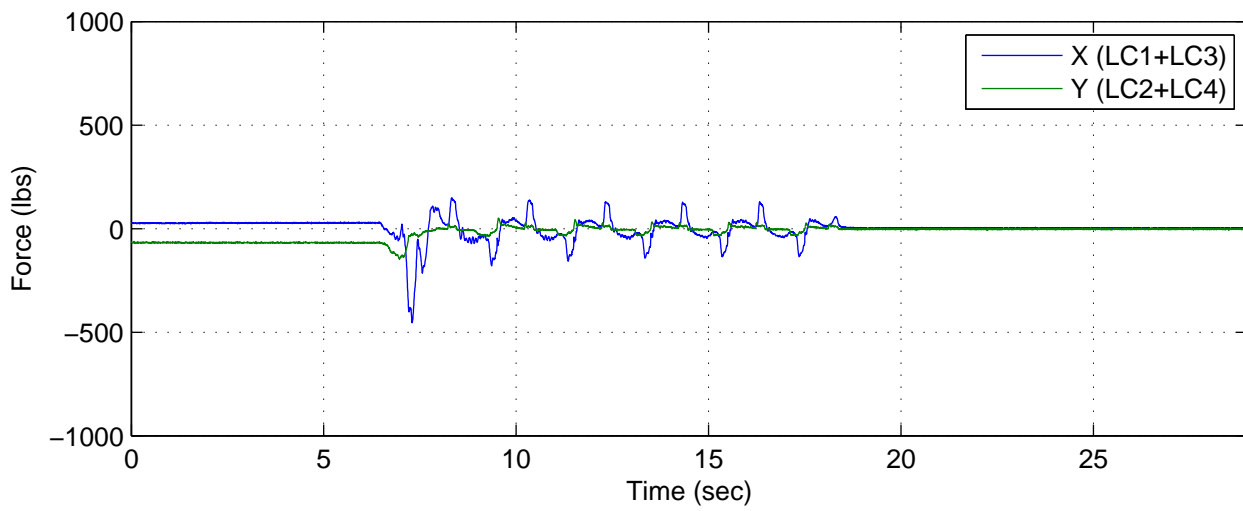
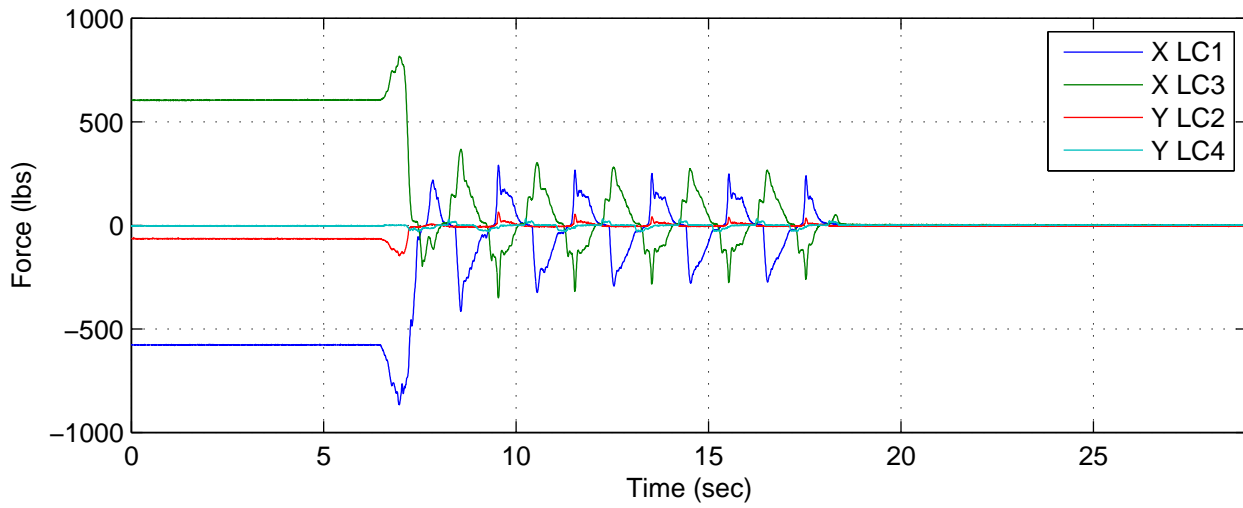
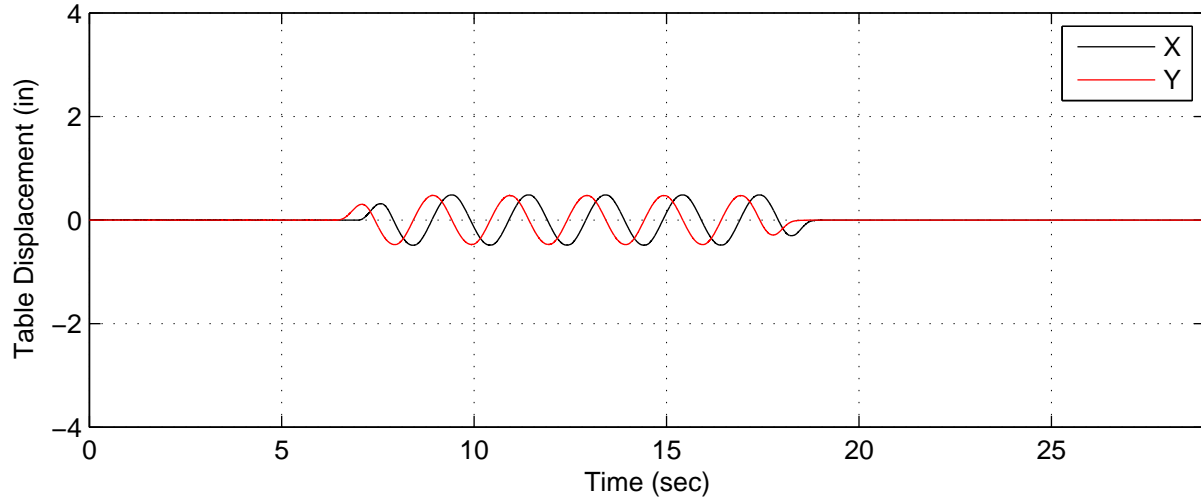

AP4 (No Added Mass) – Test I, 0.5in. Dynamic X+Y Disp

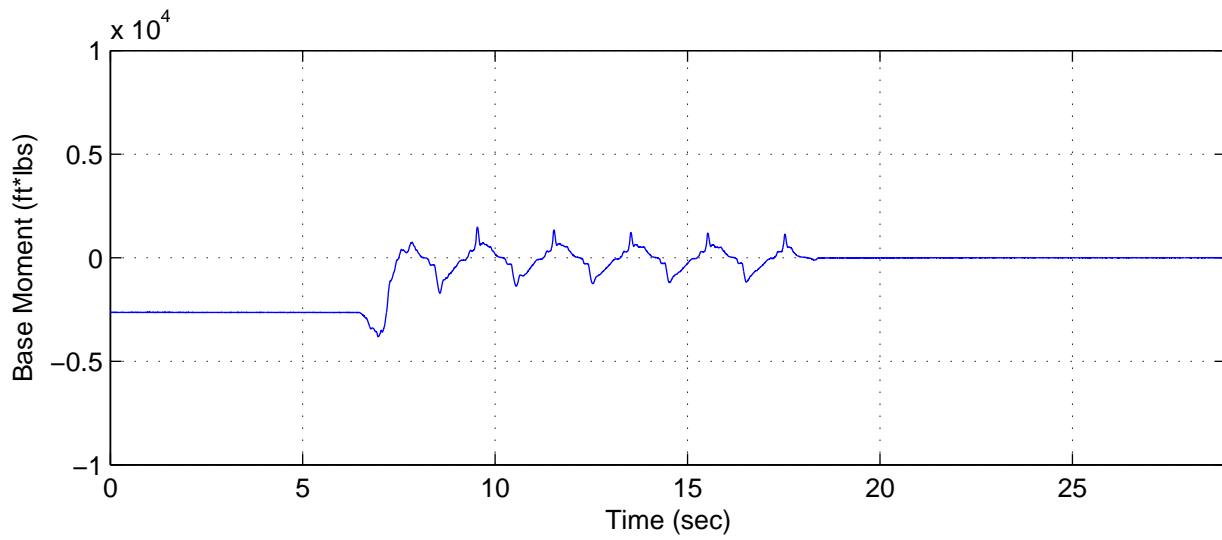
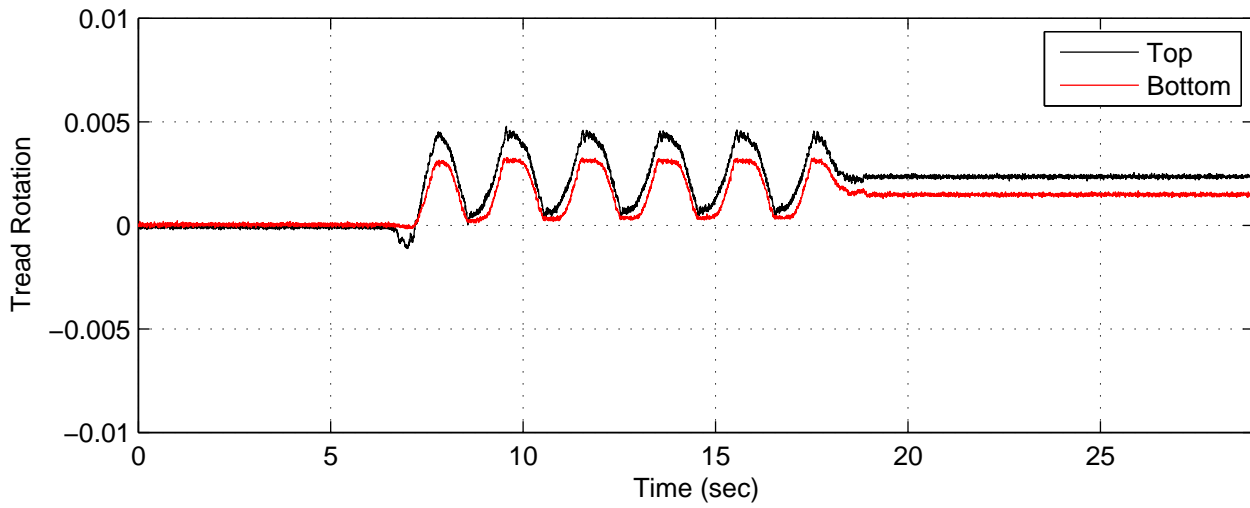
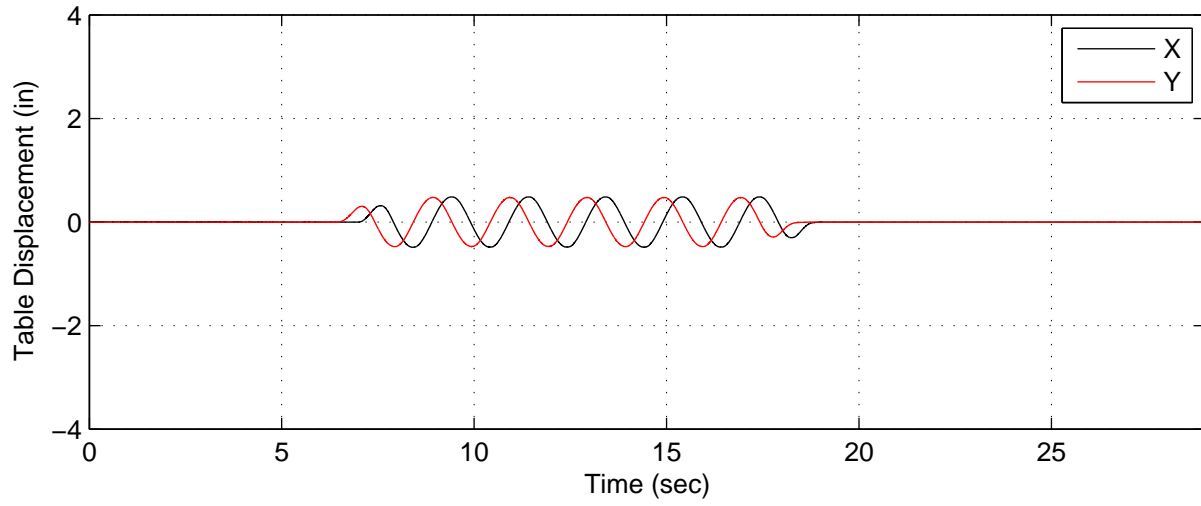

AP4 (No Added Mass) – Test J, 2.5in. Dynamic X+Y Disp

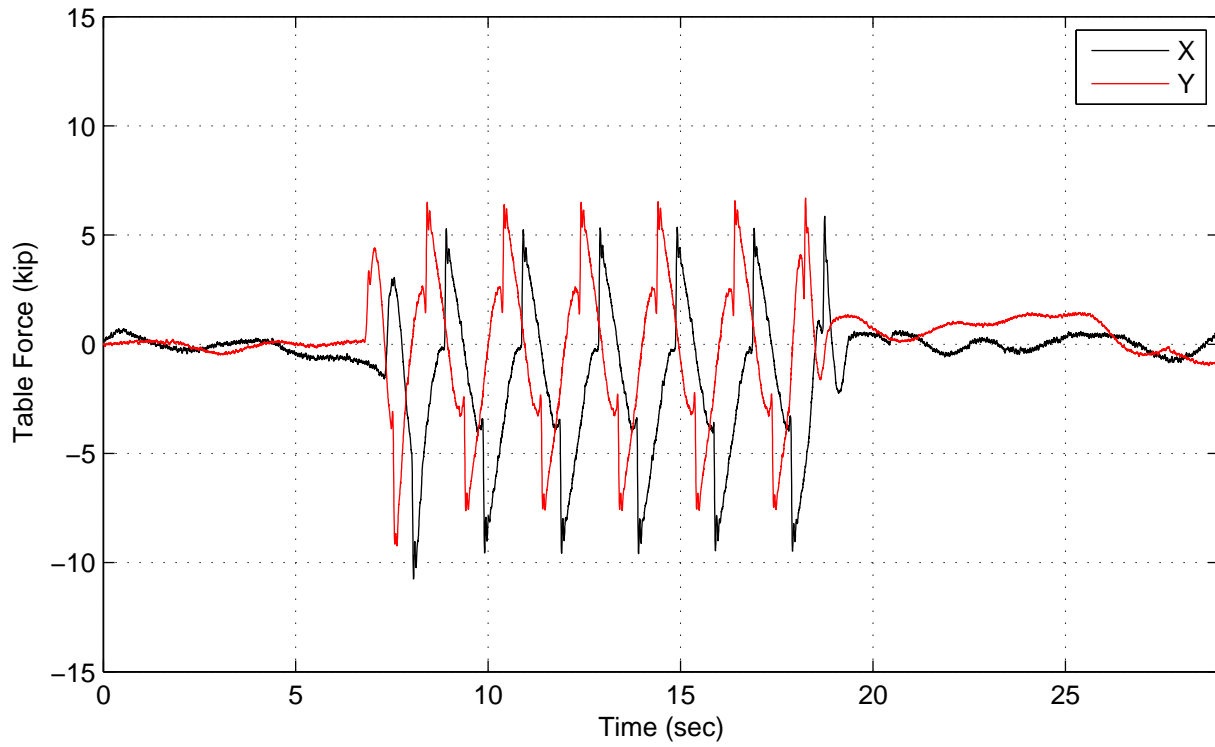
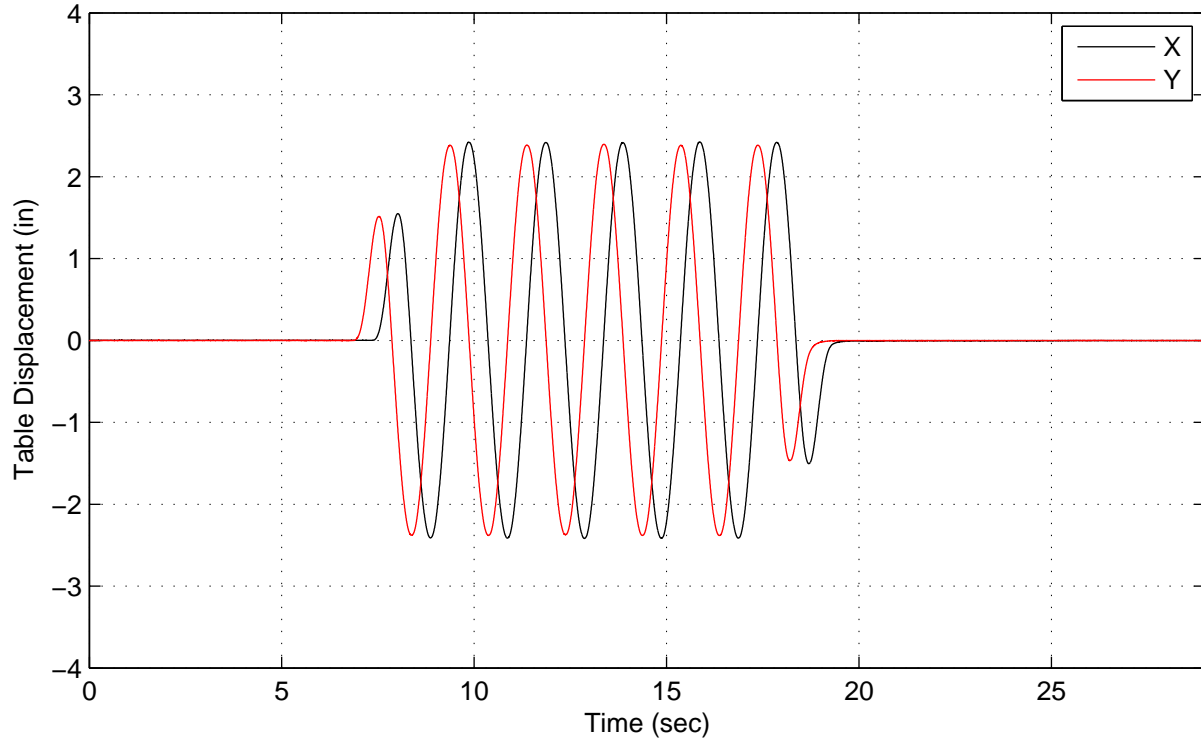

AP4 (No Added Mass) – Test J, 2.5in. Dynamic X+Y Disp

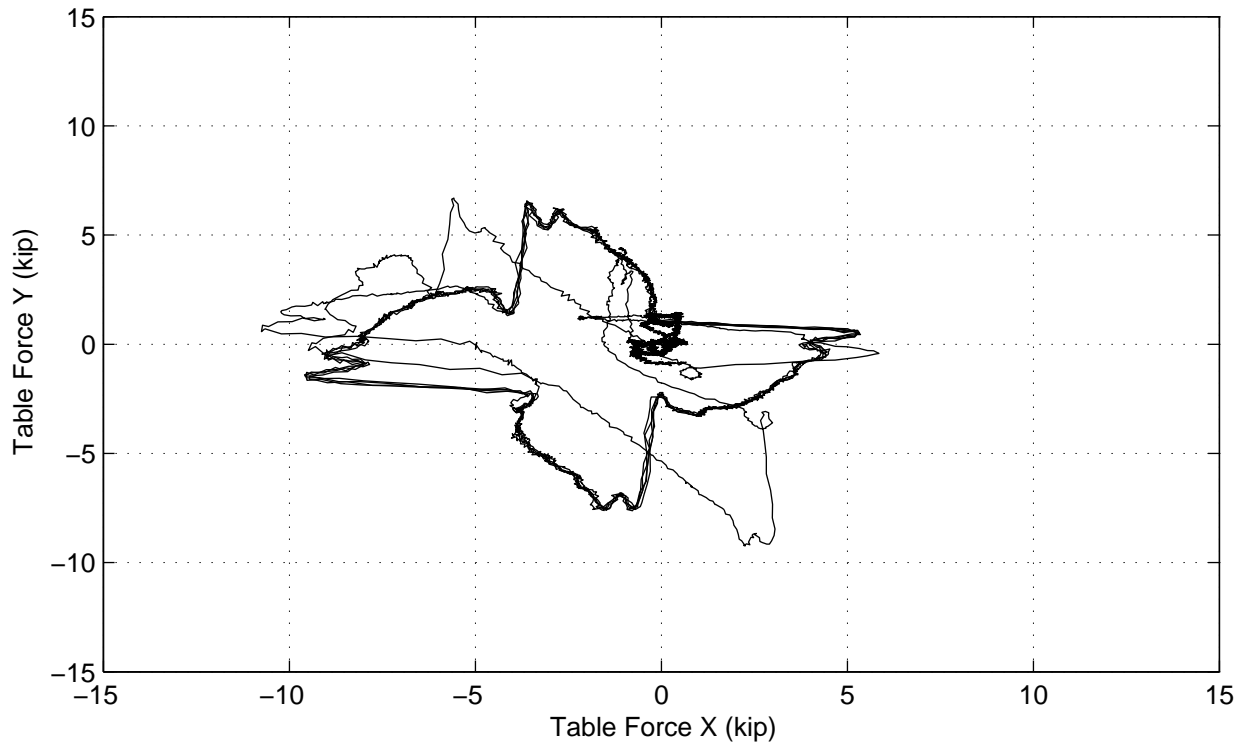
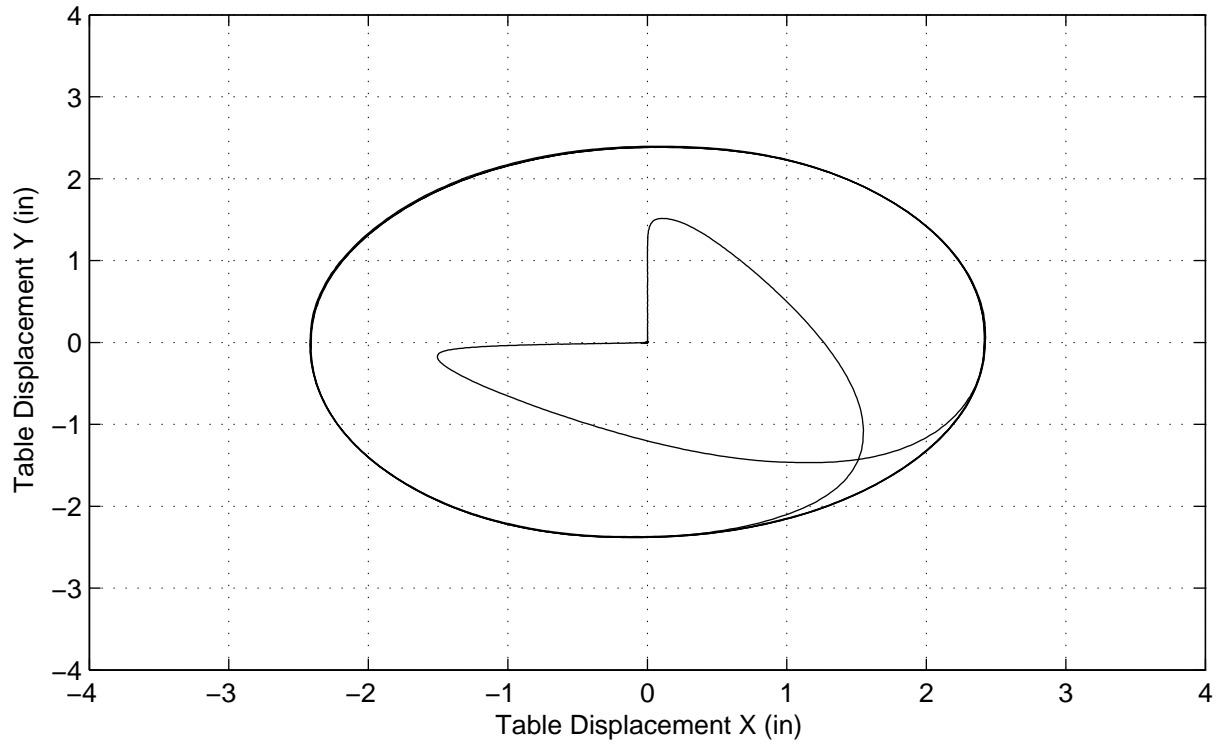

AP4 (No Added Mass) – Test J, 2.5in. Dynamic X+Y Disp

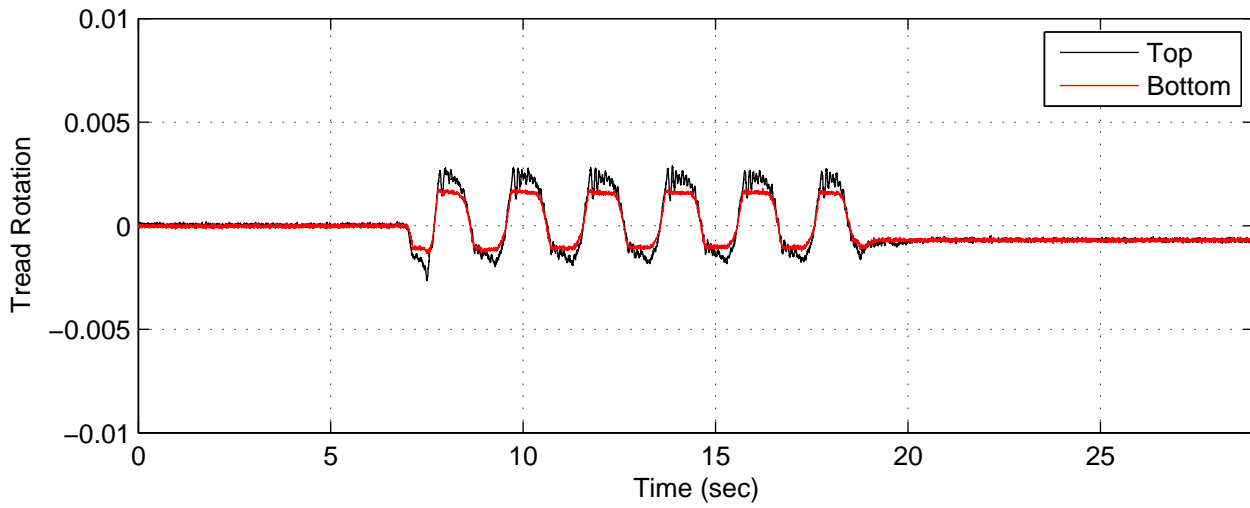
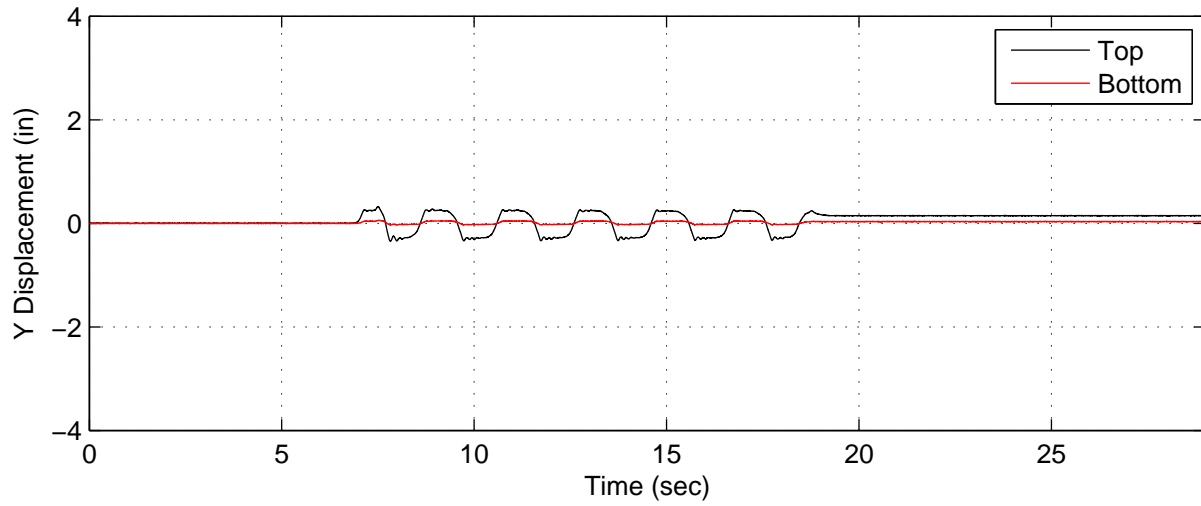
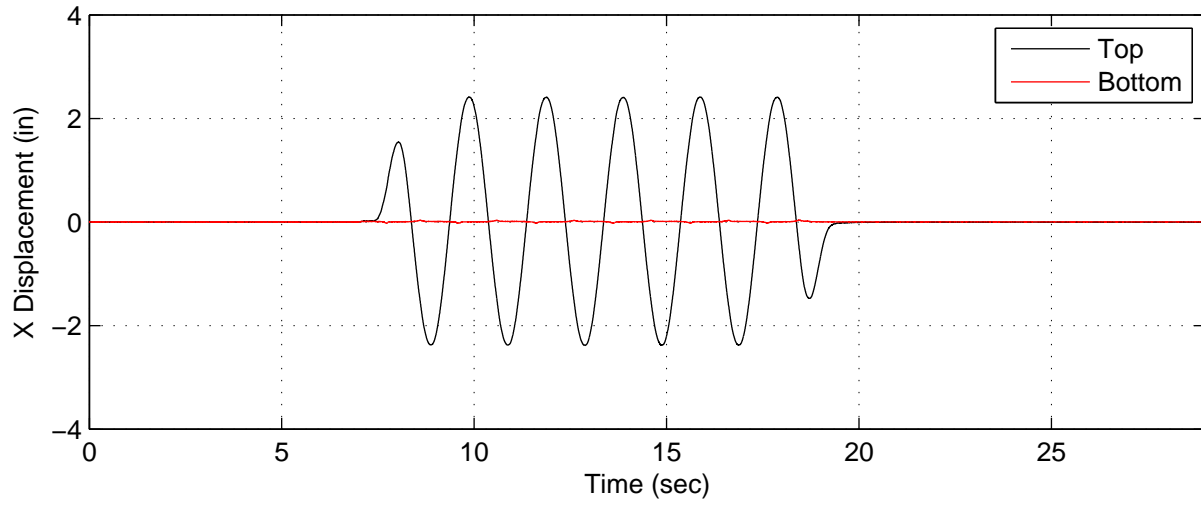



AP4 (No Added Mass) – Test J, 2.5in. Dynamic X+Y Disp

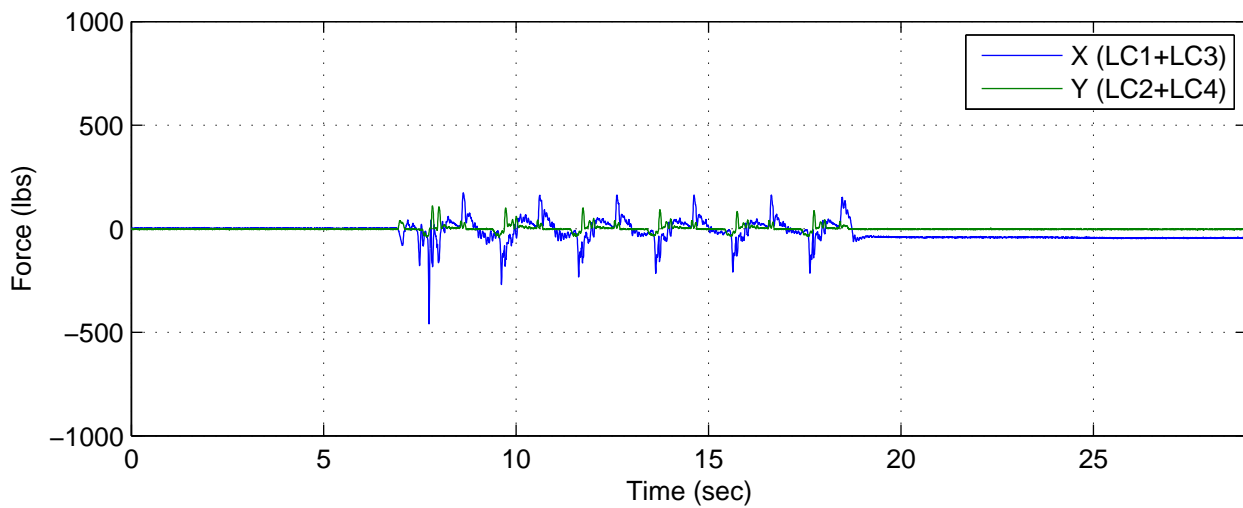
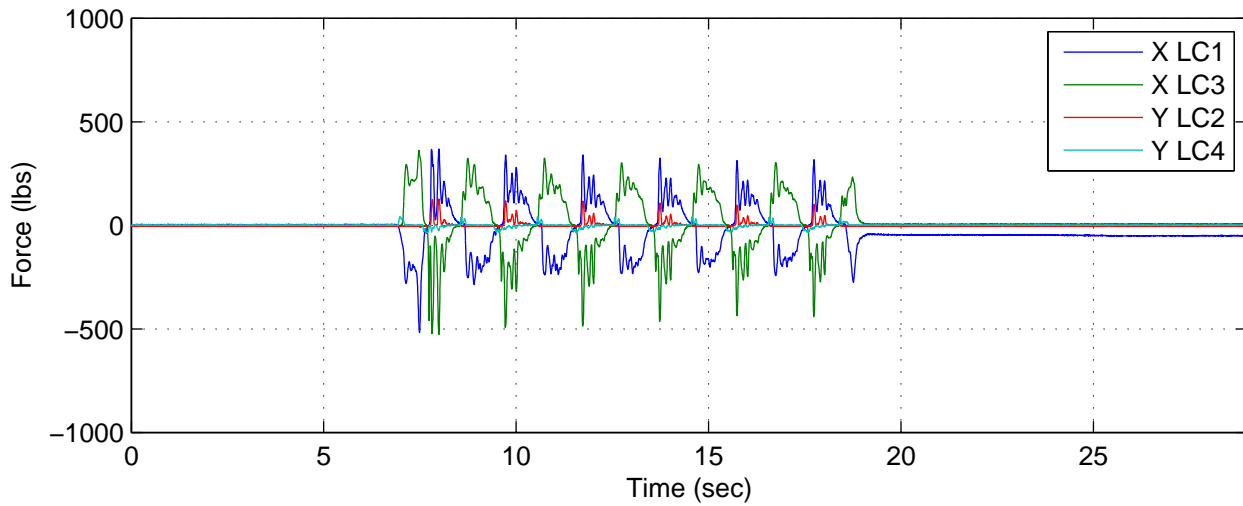
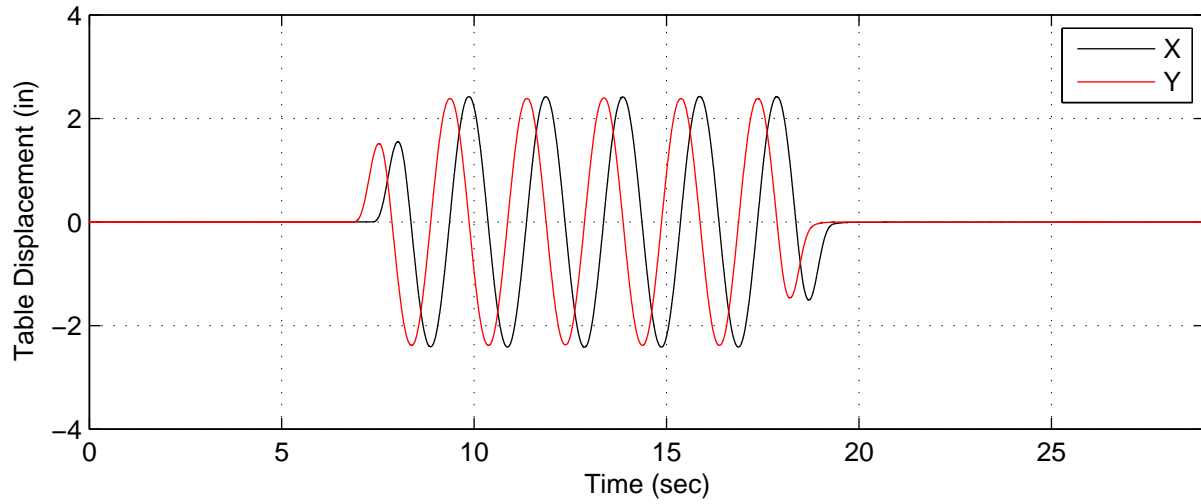

AP4 (No Added Mass) – Test J, 2.5in. Dynamic X+Y Disp

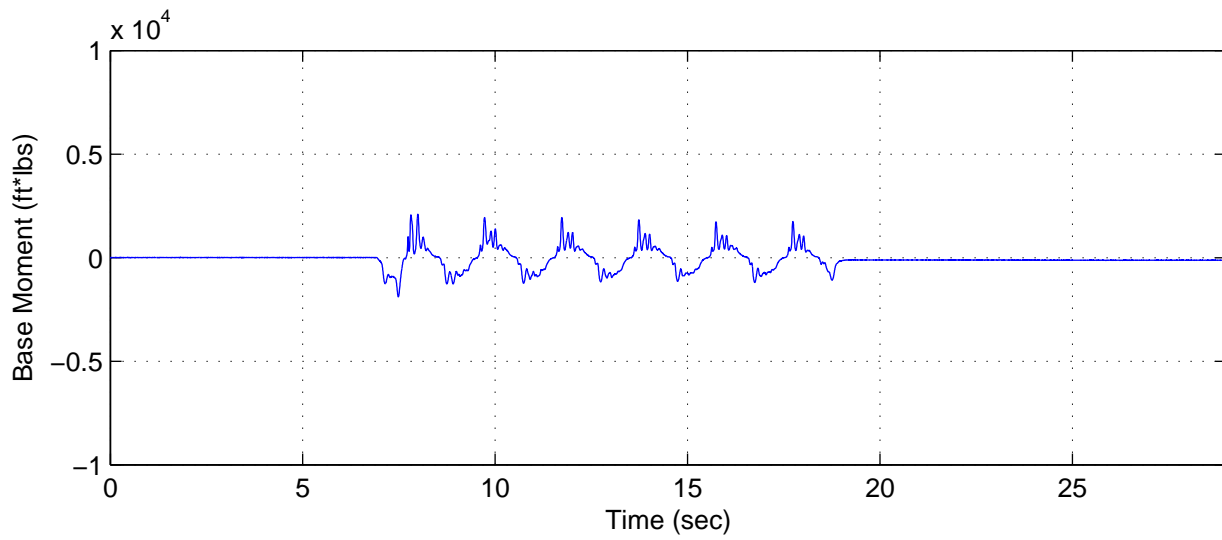
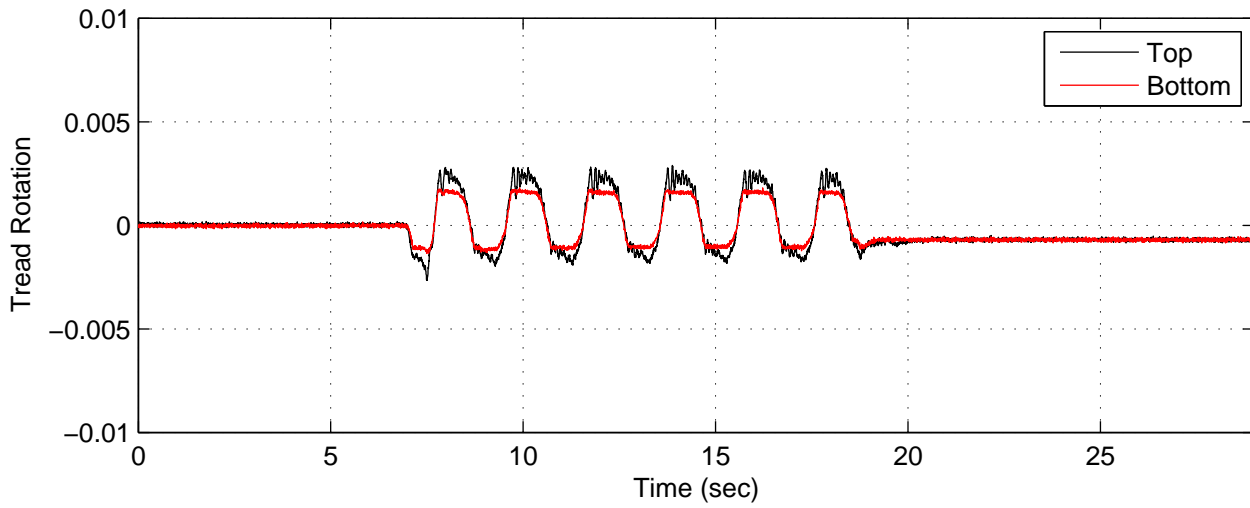
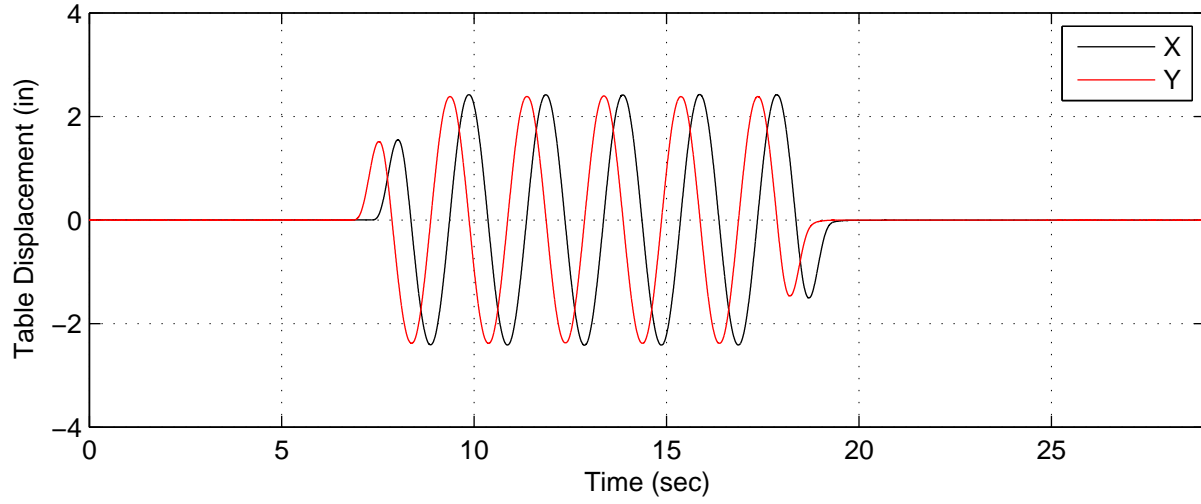

AP4 (No Added Mass) – Test K, 3.75in. Dynamic X+Y Disp

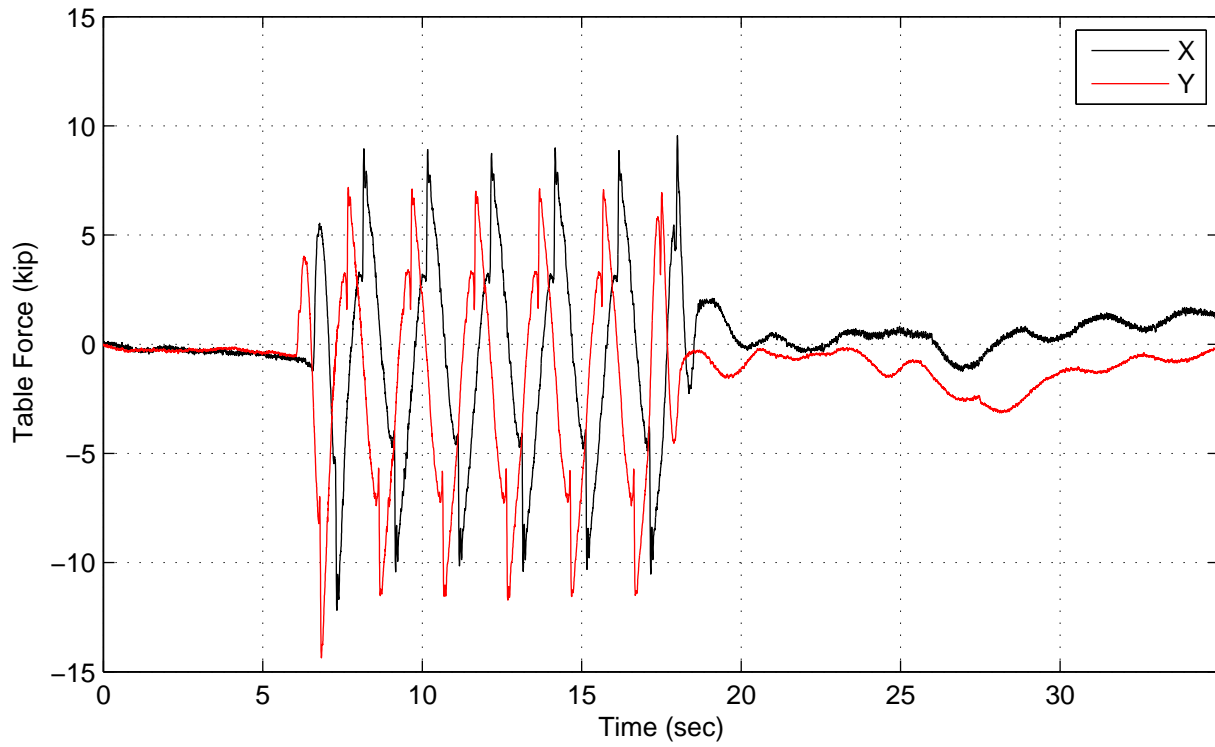
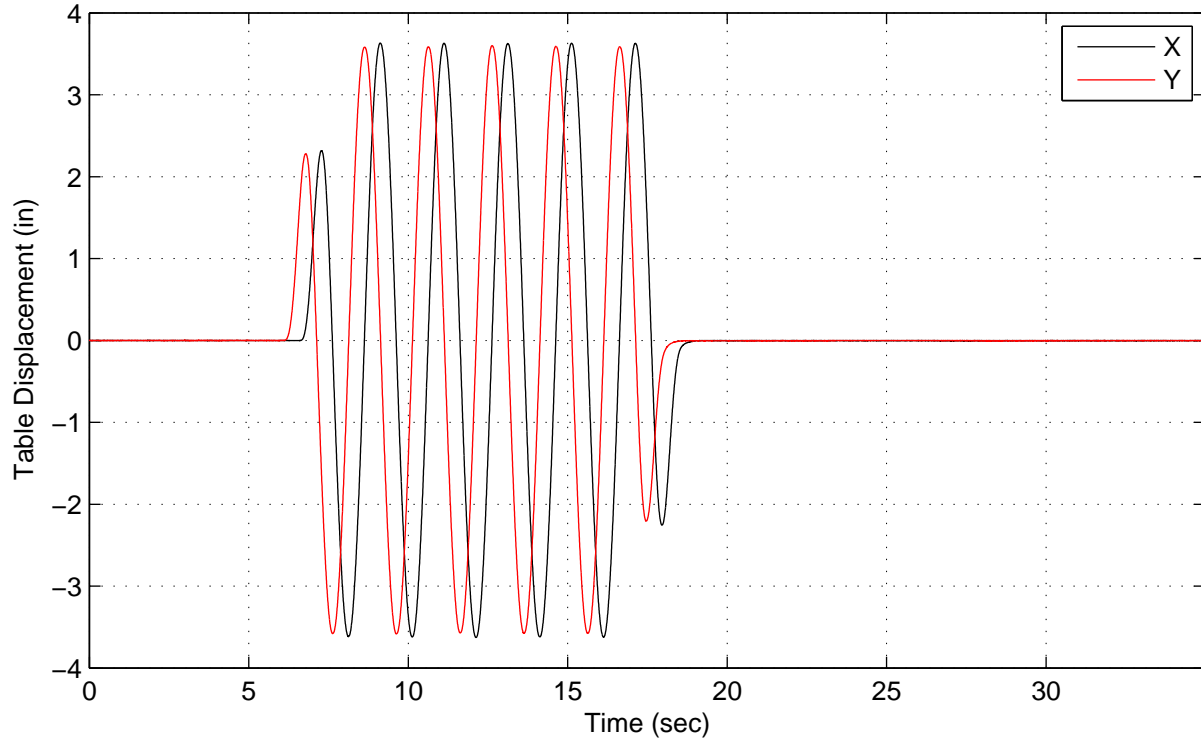

AP4 (No Added Mass) – Test K, 3.75in. Dynamic X+Y Disp

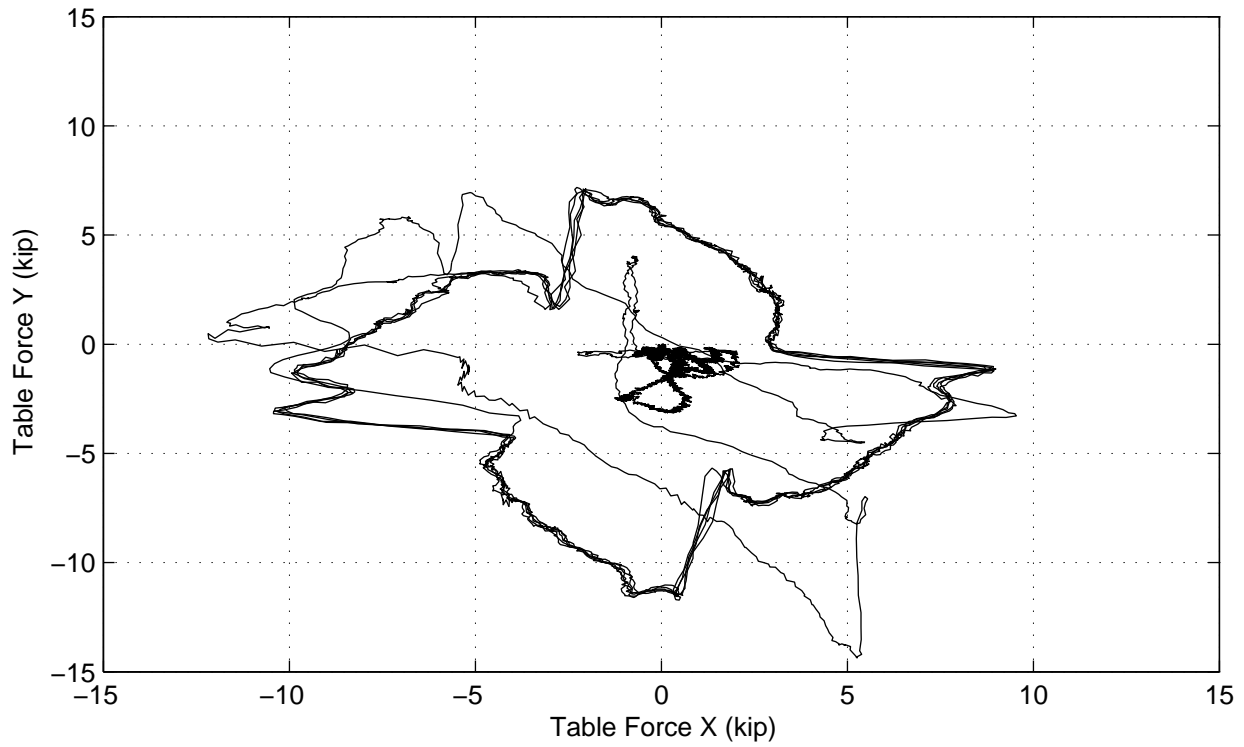
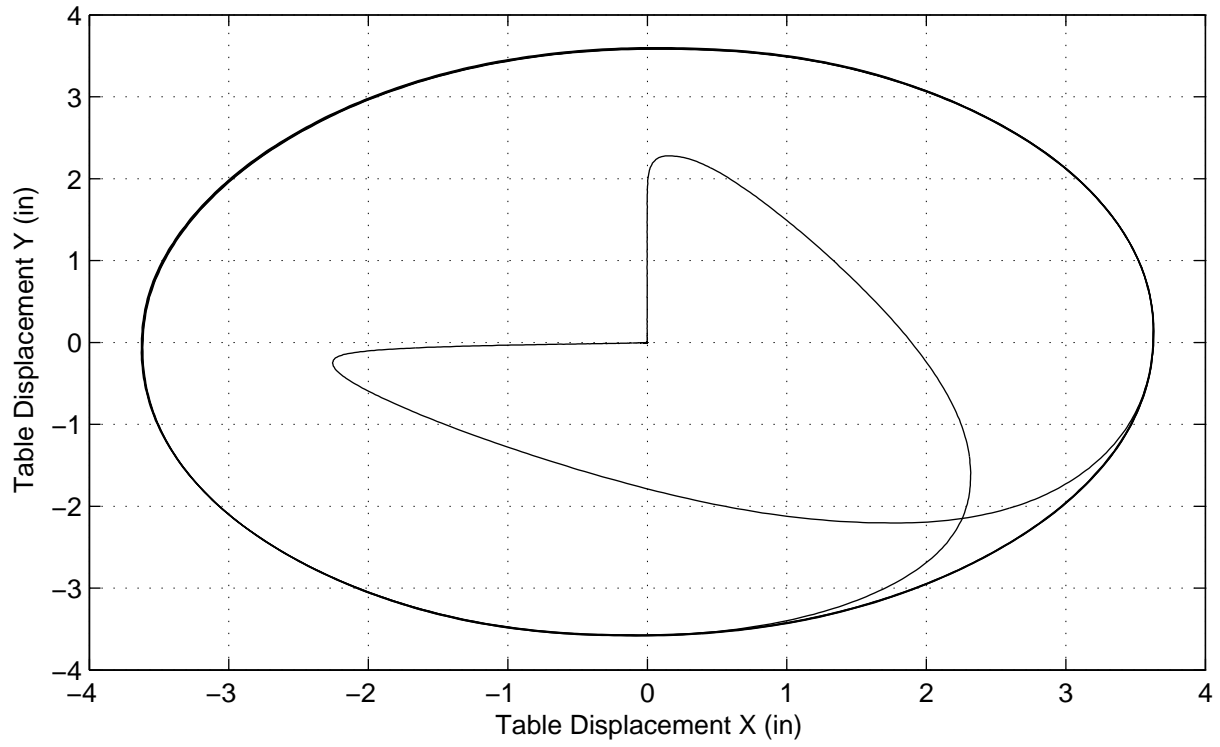

AP4 (No Added Mass) – Test K, 3.75in. Dynamic X+Y Disp

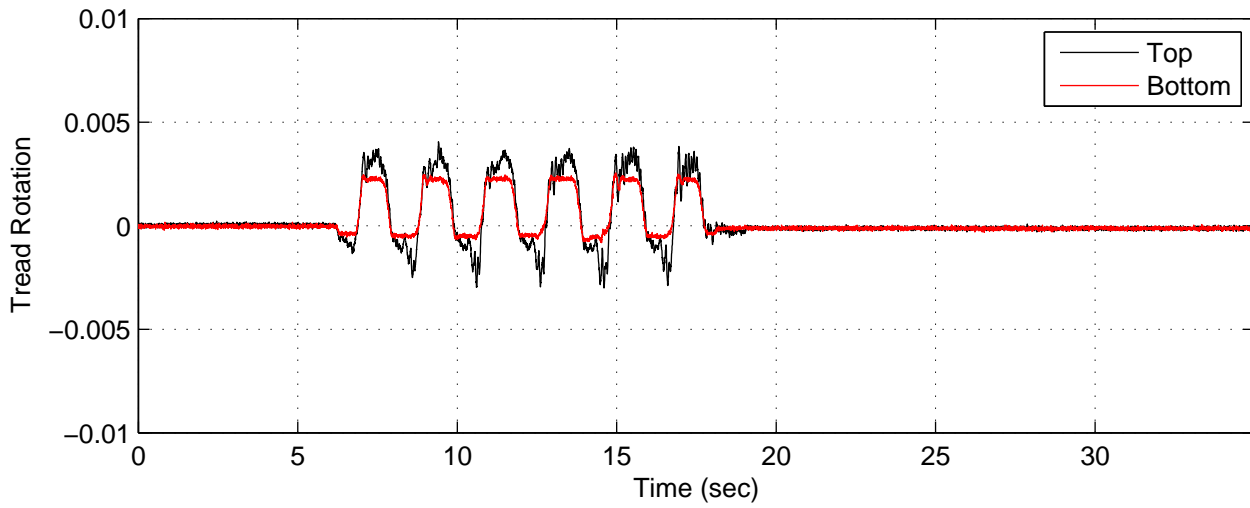
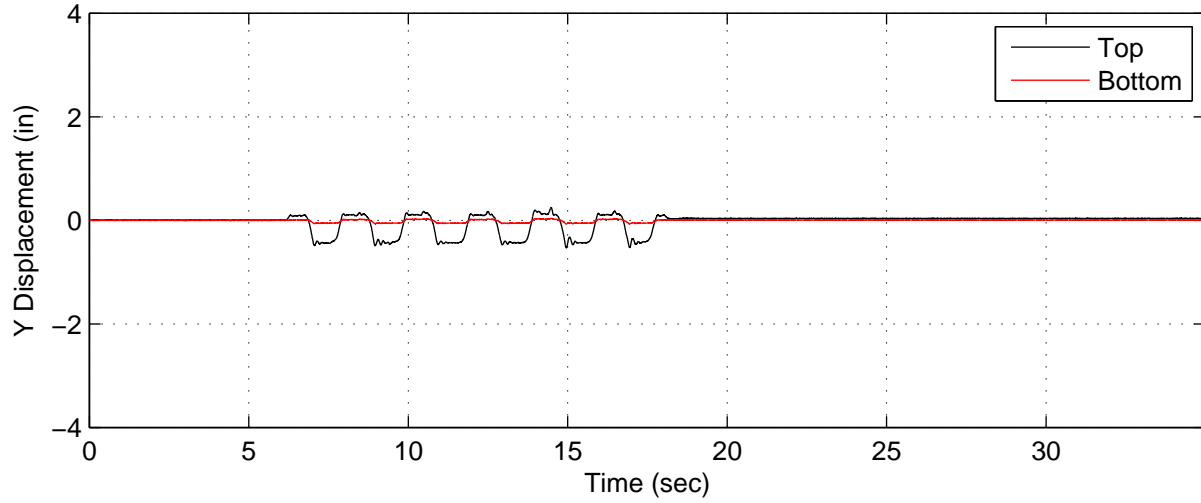
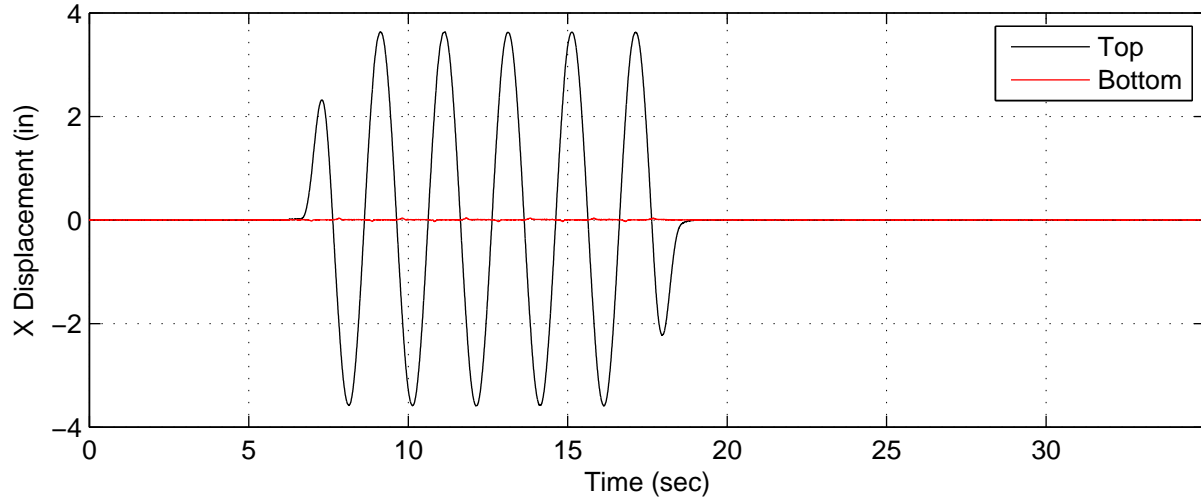

AP4 (No Added Mass) – Test K, 3.75in. Dynamic X+Y Disp

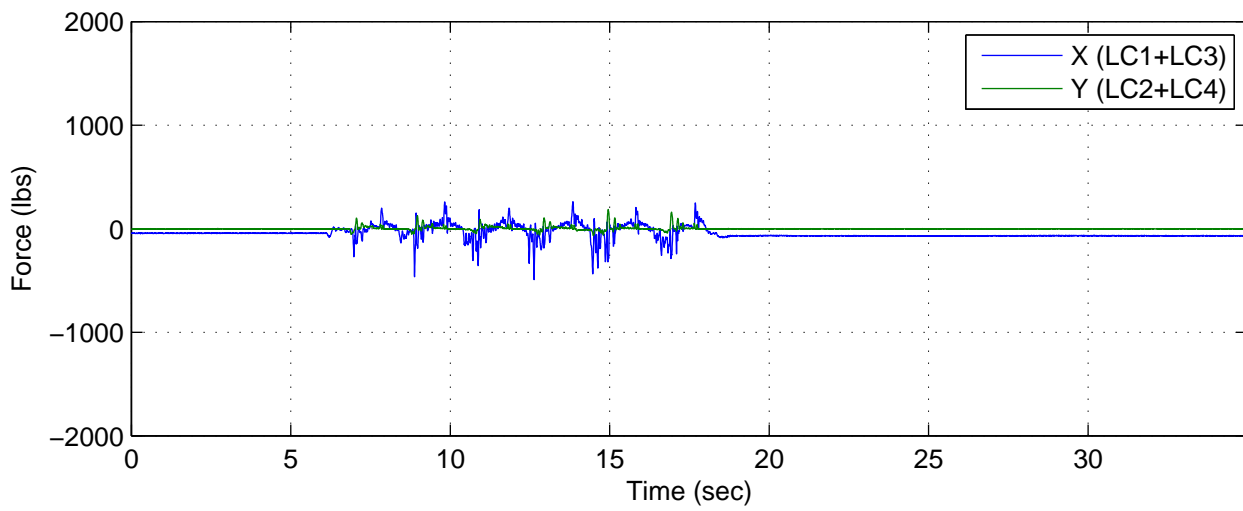
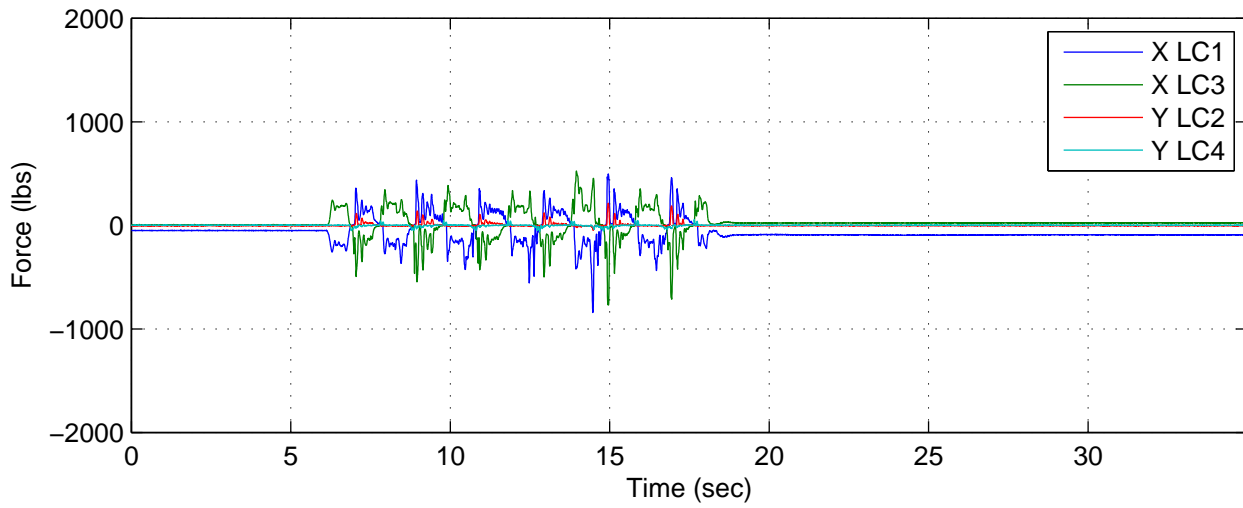
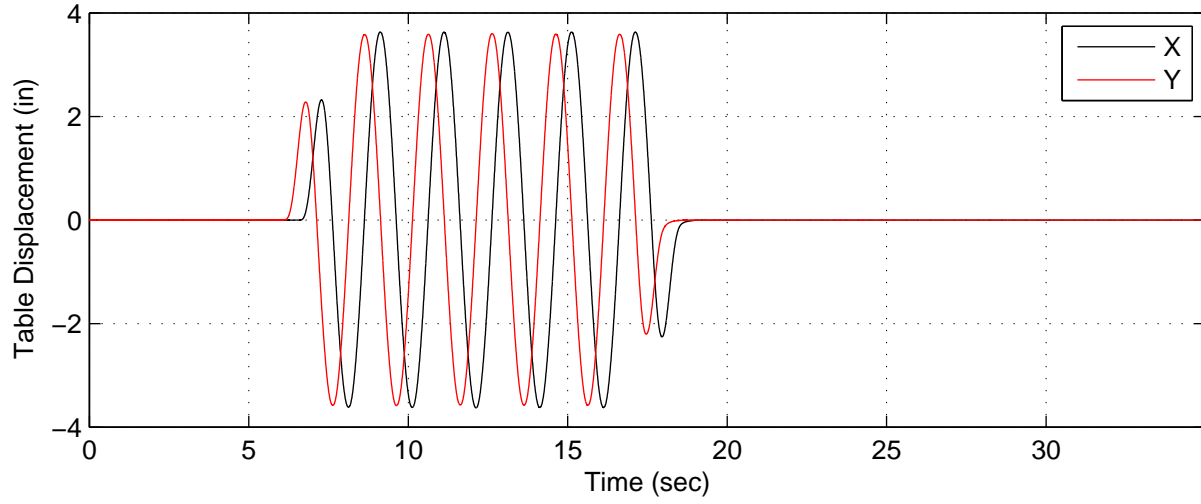

AP4 (No Added Mass) – Test K, 3.75in. Dynamic X+Y Disp

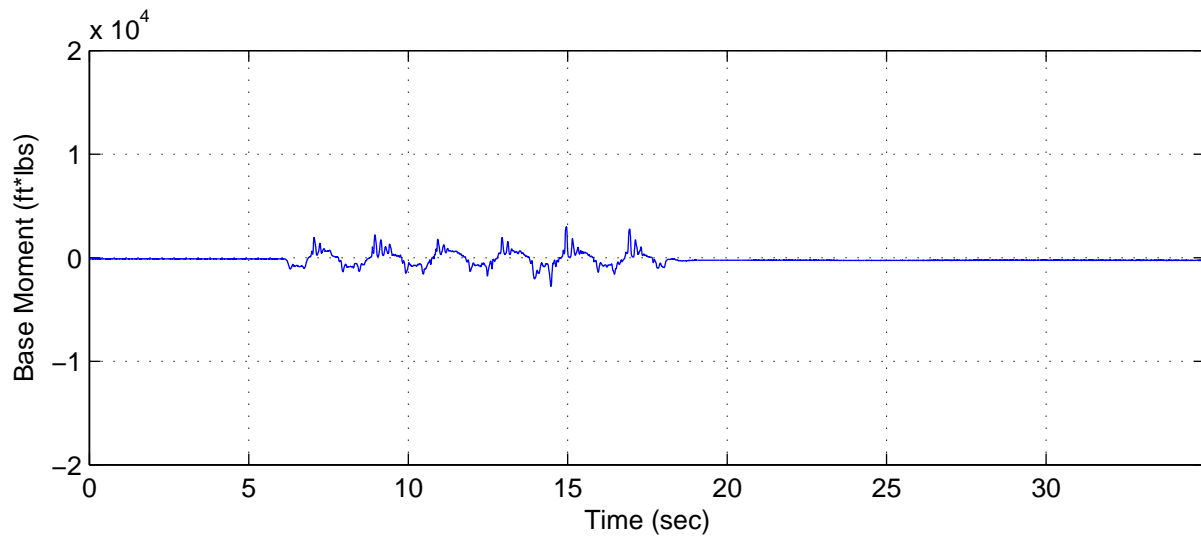
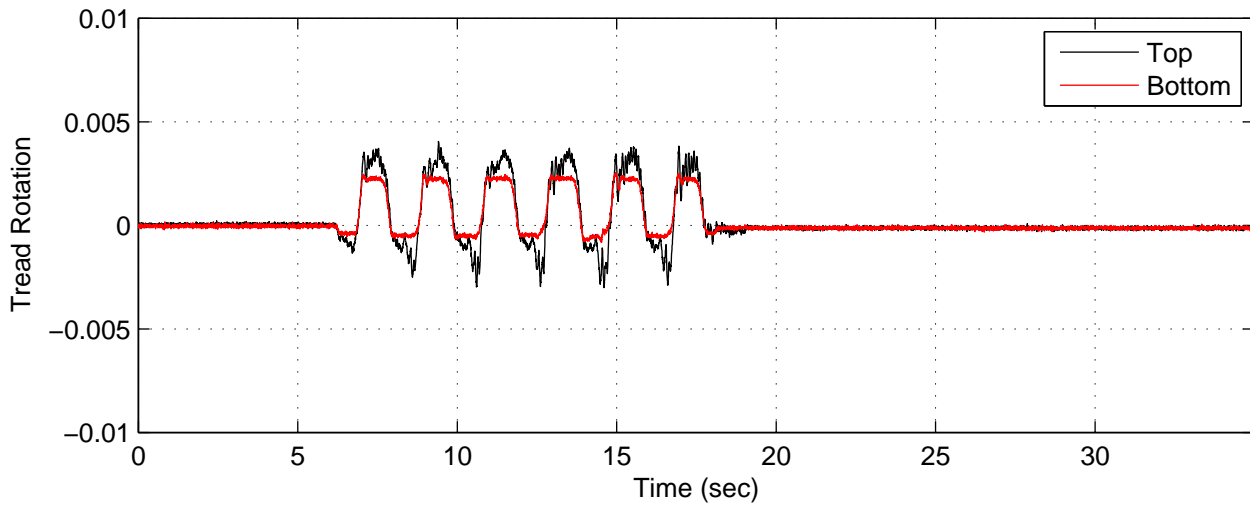
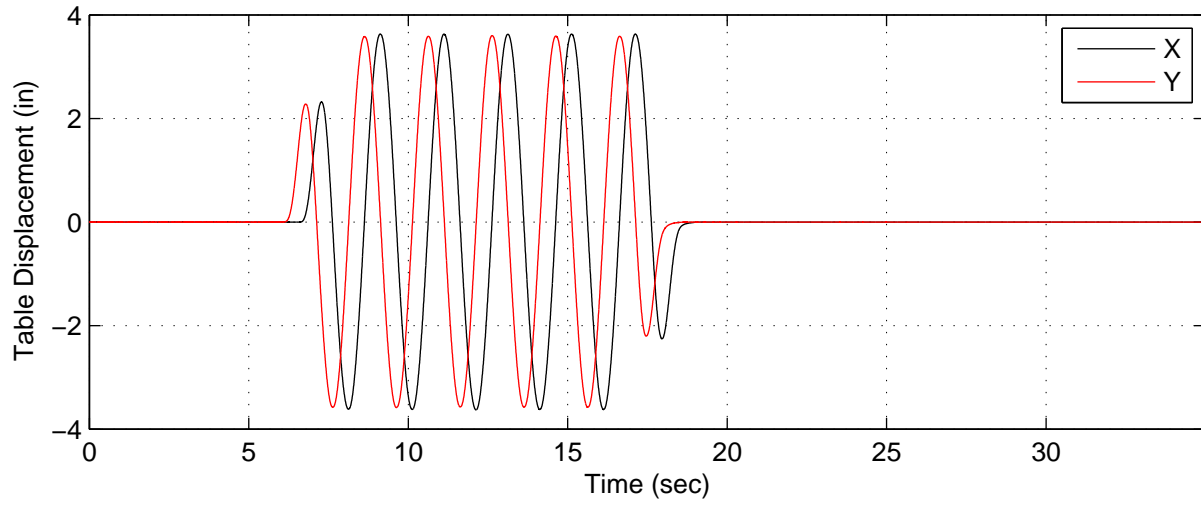

AP4 (No Added Mass) – Test L, 2.5in. Long Period DBE – 0 deg Long

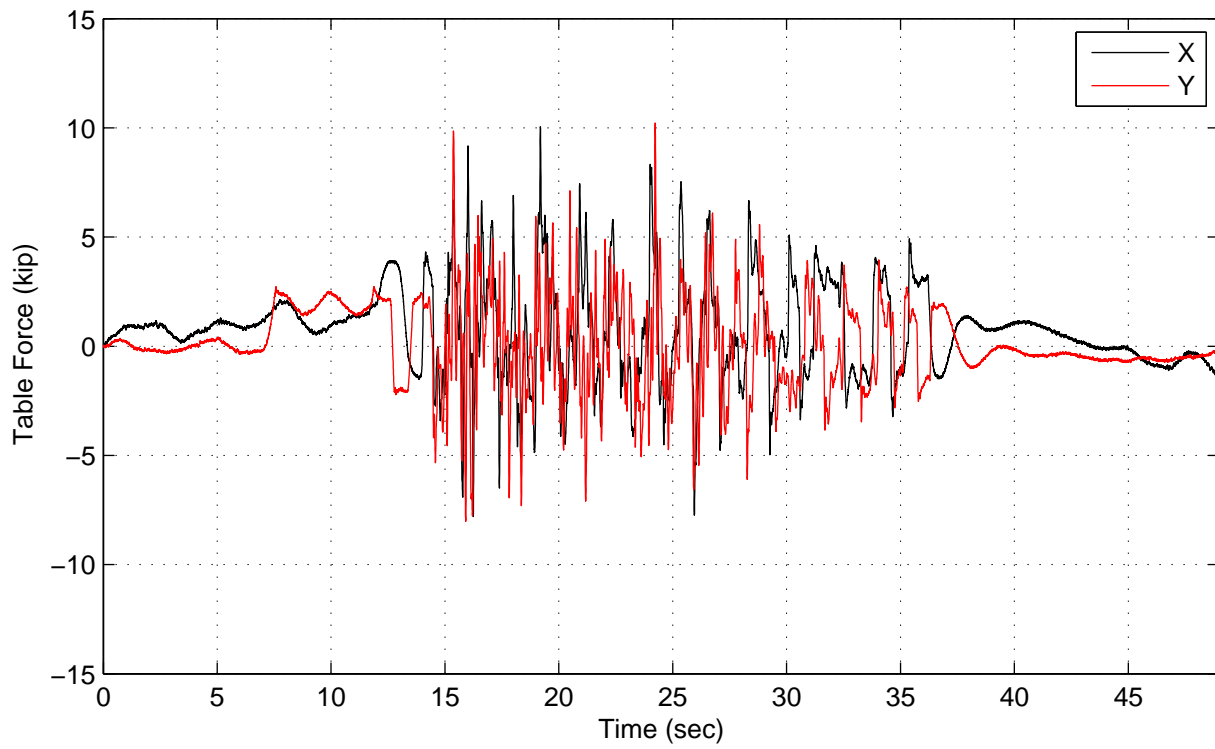
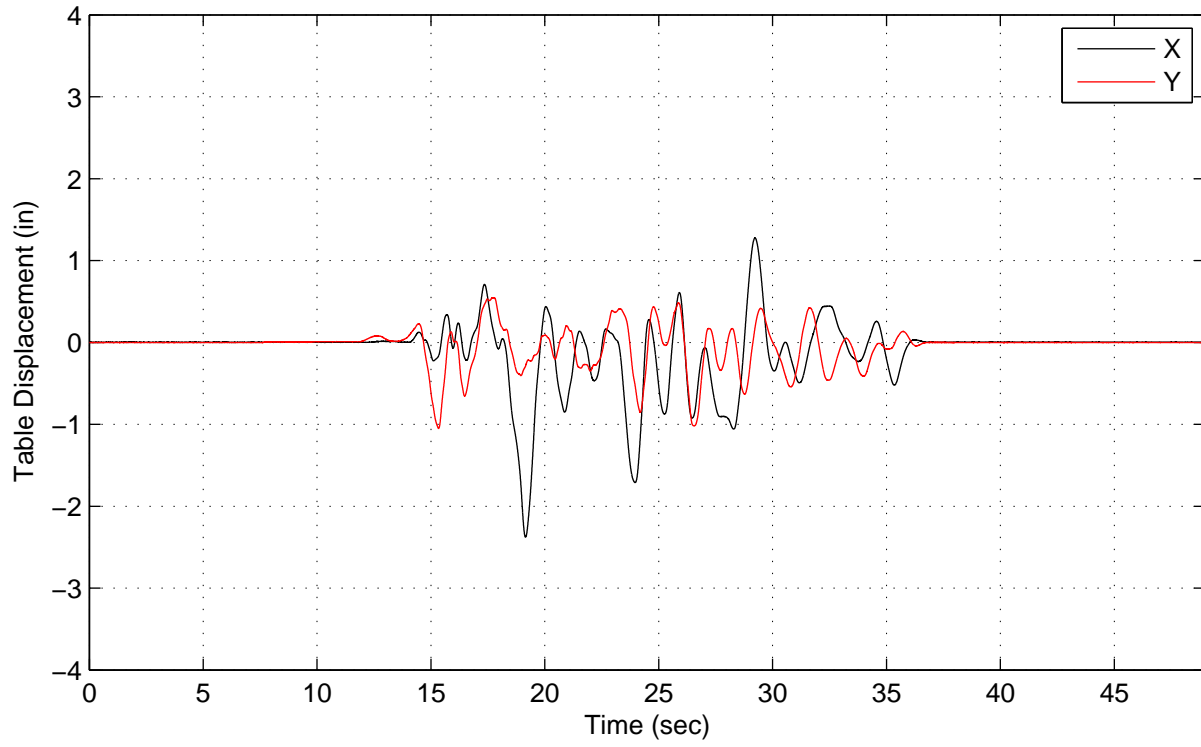



AP4 (No Added Mass) – Test L, 2.5in. Long Period DBE – 0 deg Long

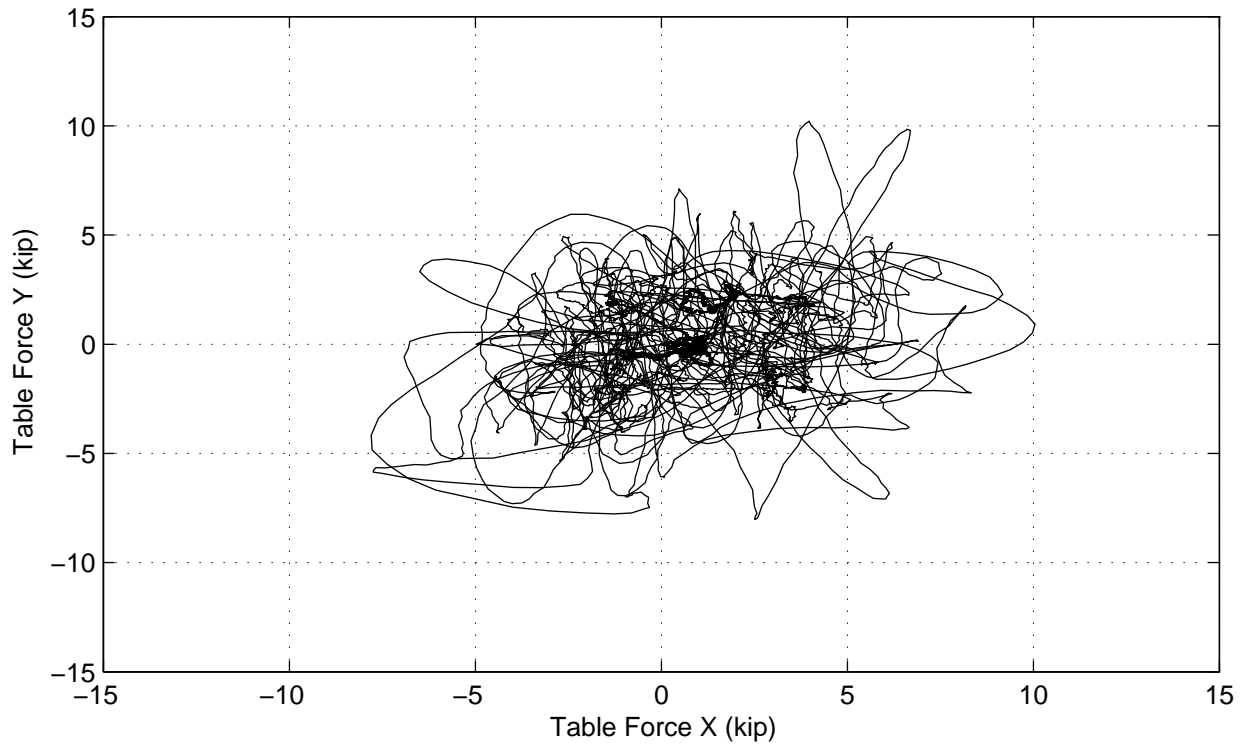
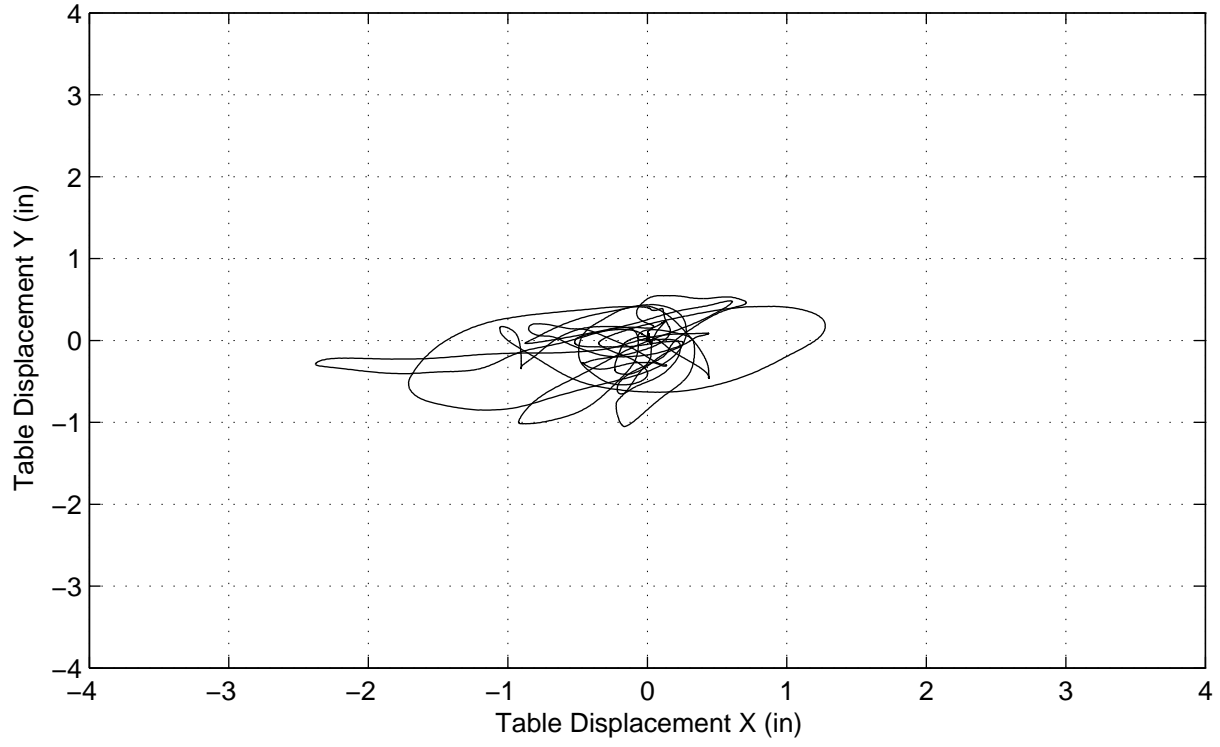

AP4 (No Added Mass) – Test L, 2.5in. Long Period DBE – 0 deg Long

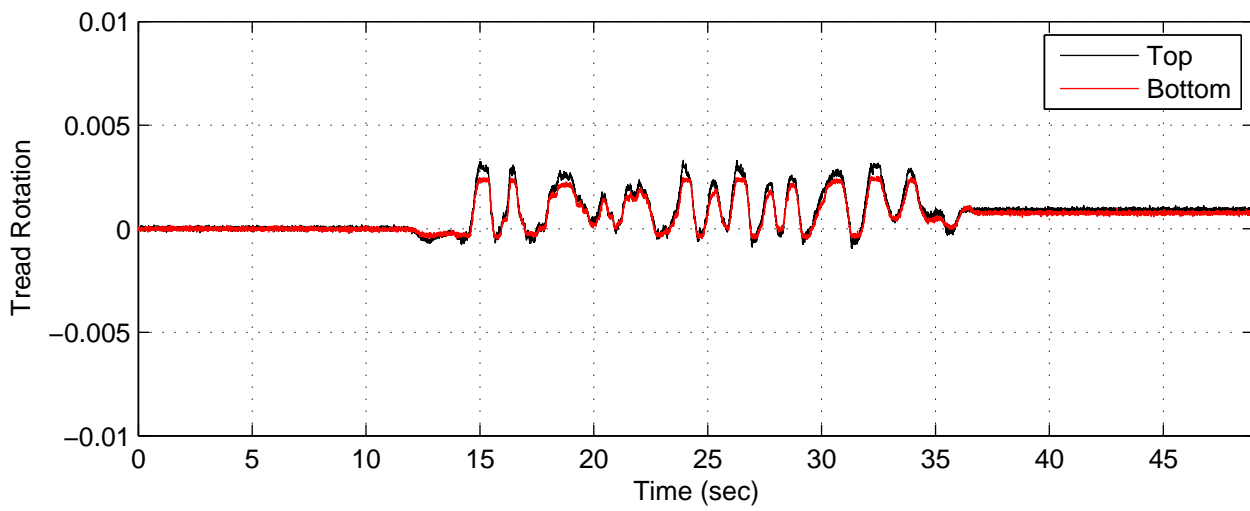
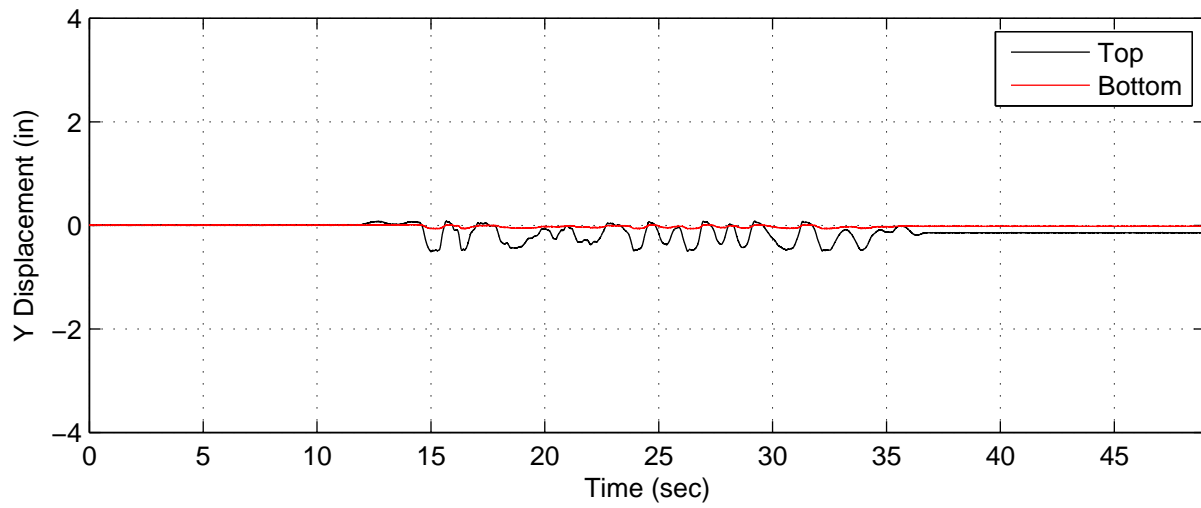
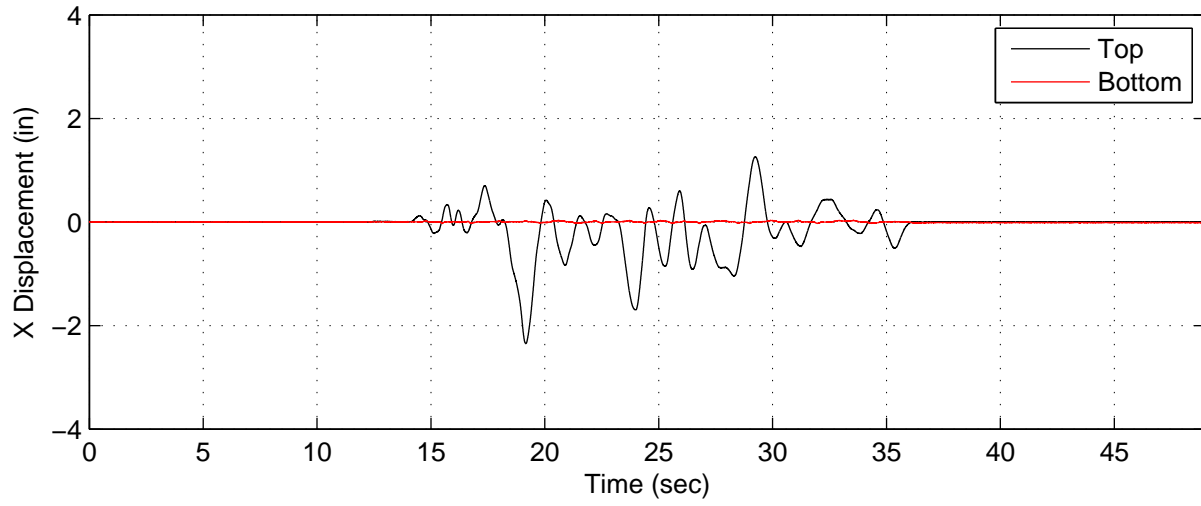

AP4 (No Added Mass) – Test L, 2.5in. Long Period DBE – 0 deg Long

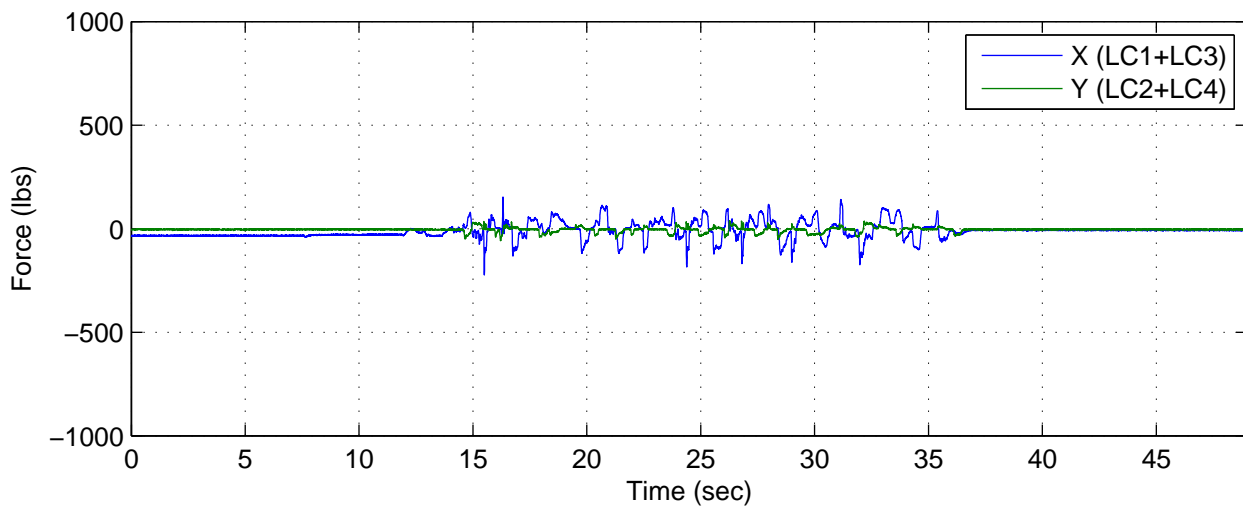
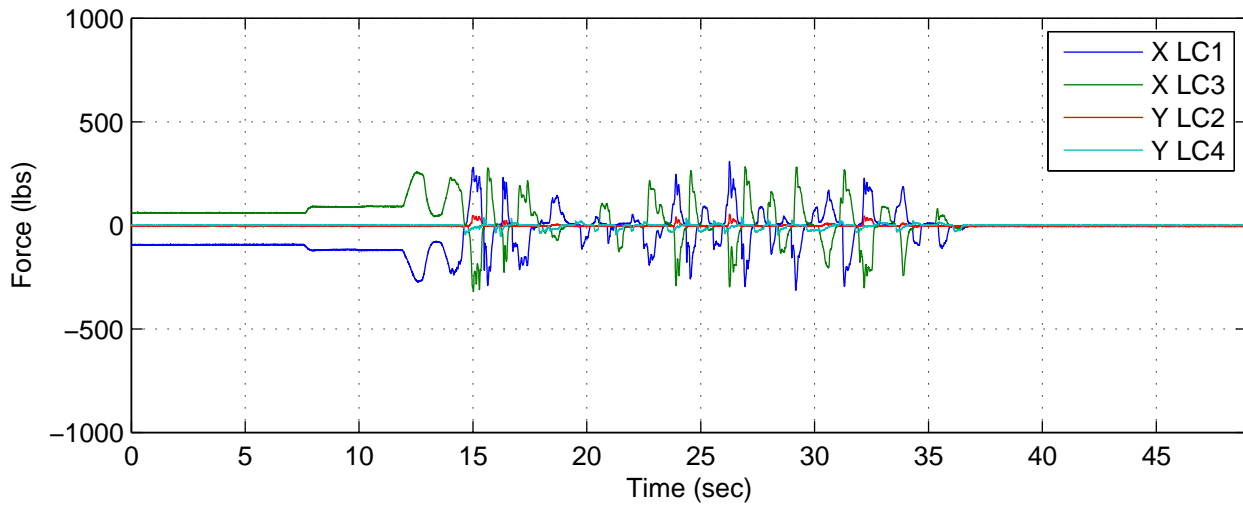
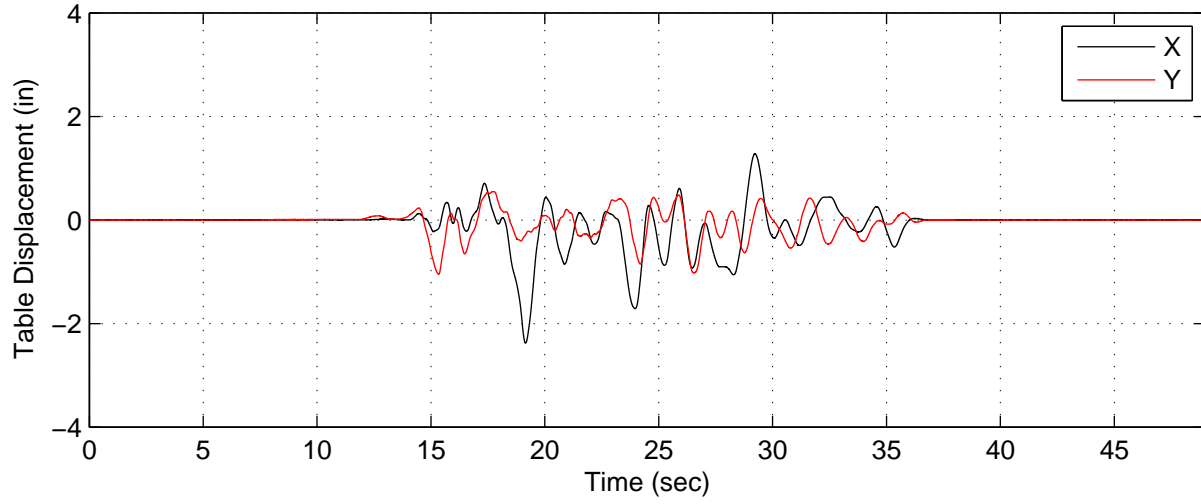

AP4 (No Added Mass) – Test L, 2.5in. Long Period DBE – 0 deg Long

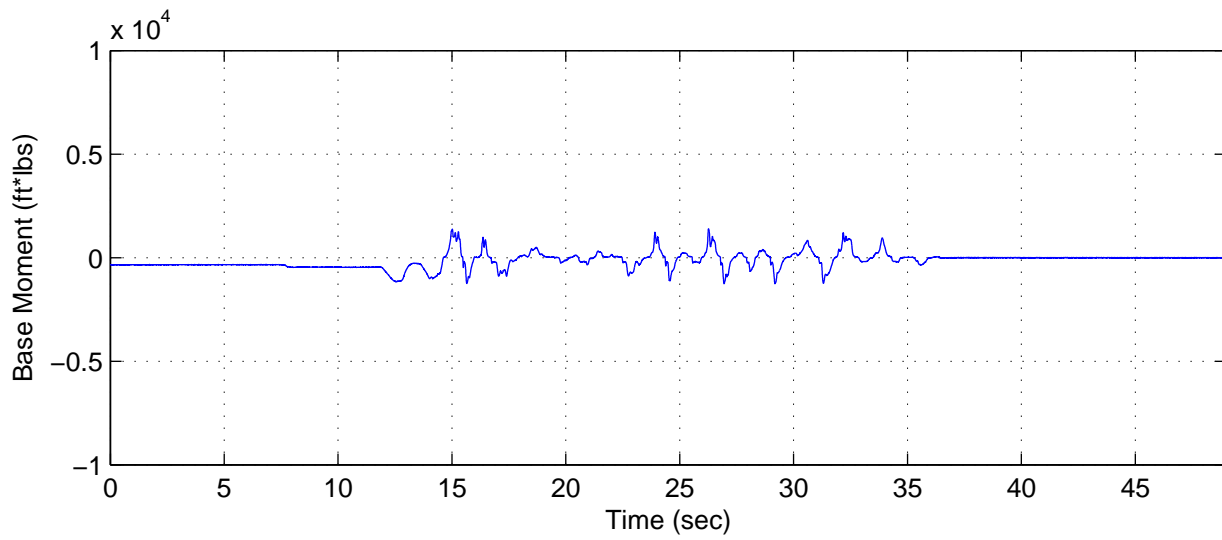
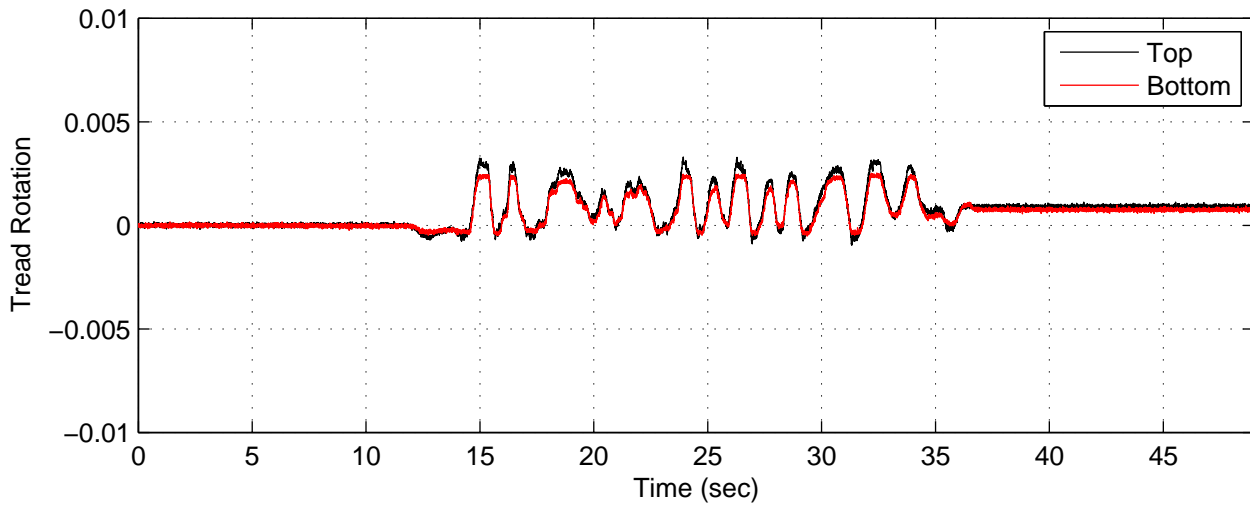
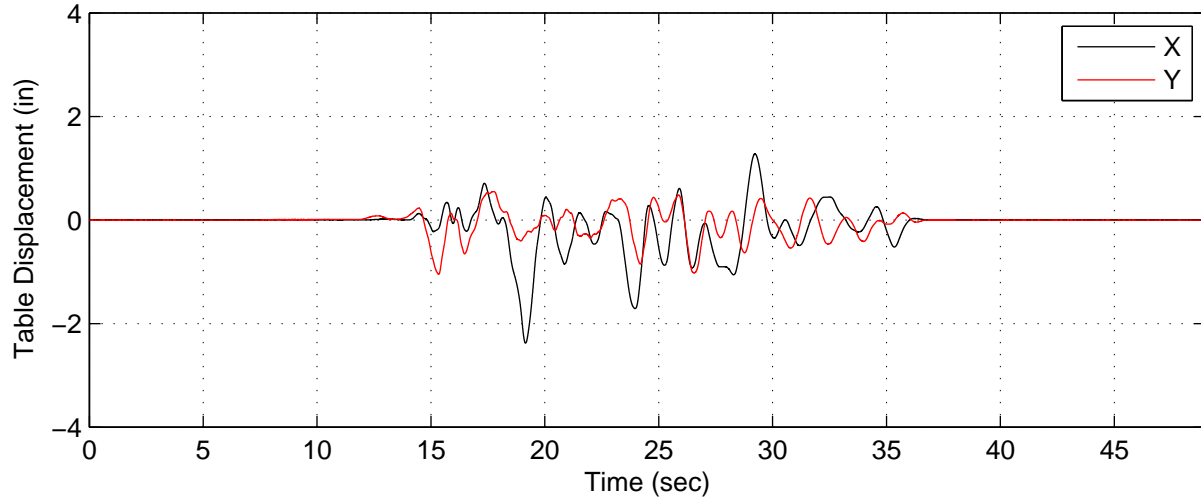

AP4 (No Added Mass) – Test M, 2.5in. Long Period DBE – 0 deg Trans

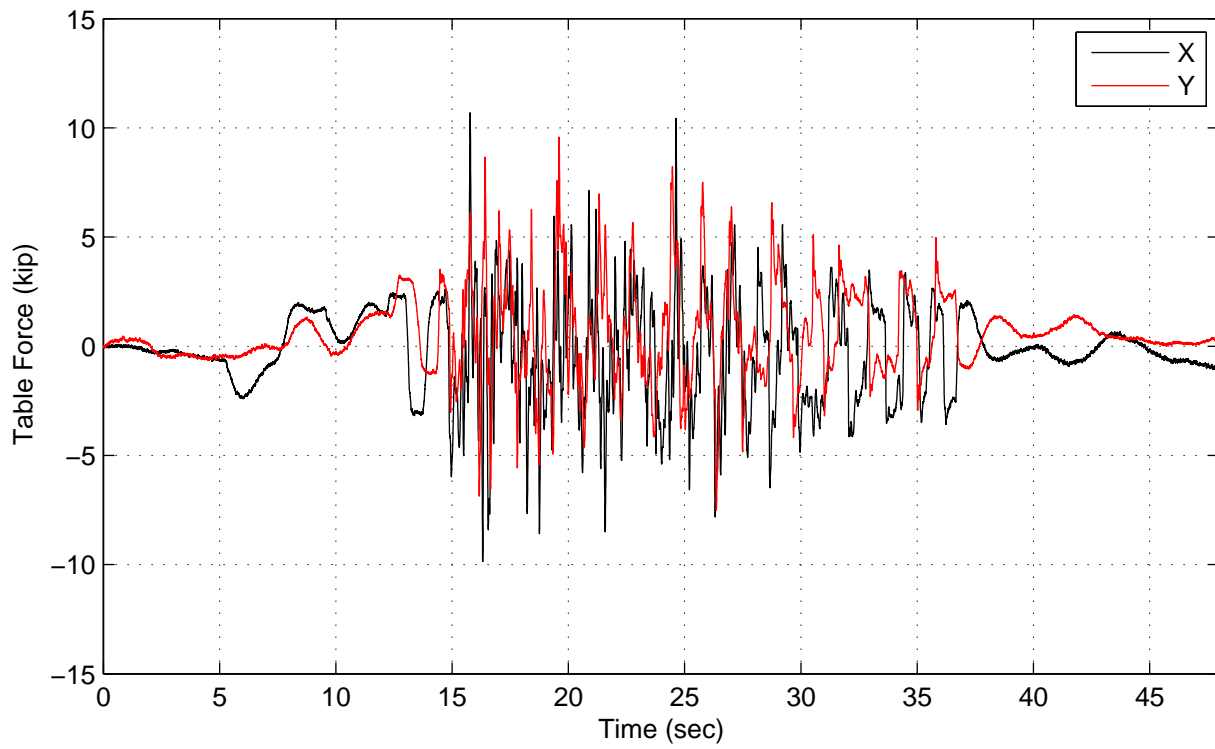
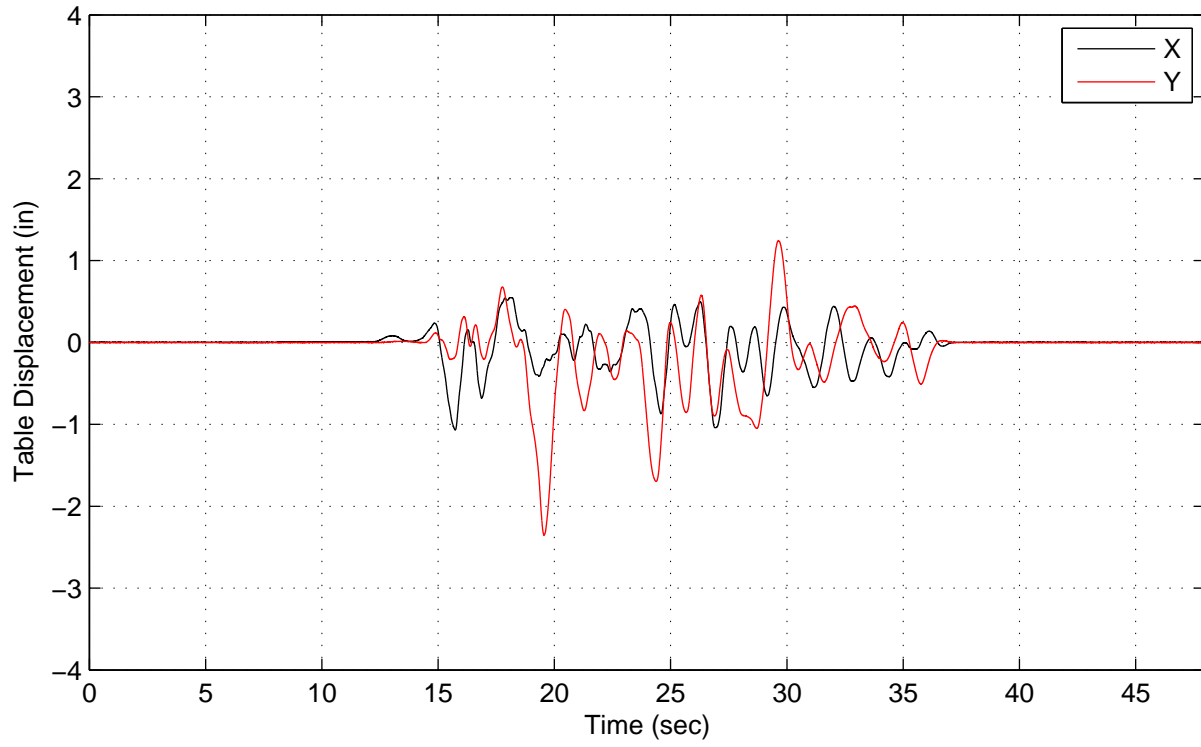

AP4 (No Added Mass) – Test M, 2.5in. Long Period DBE – 0 deg Trans

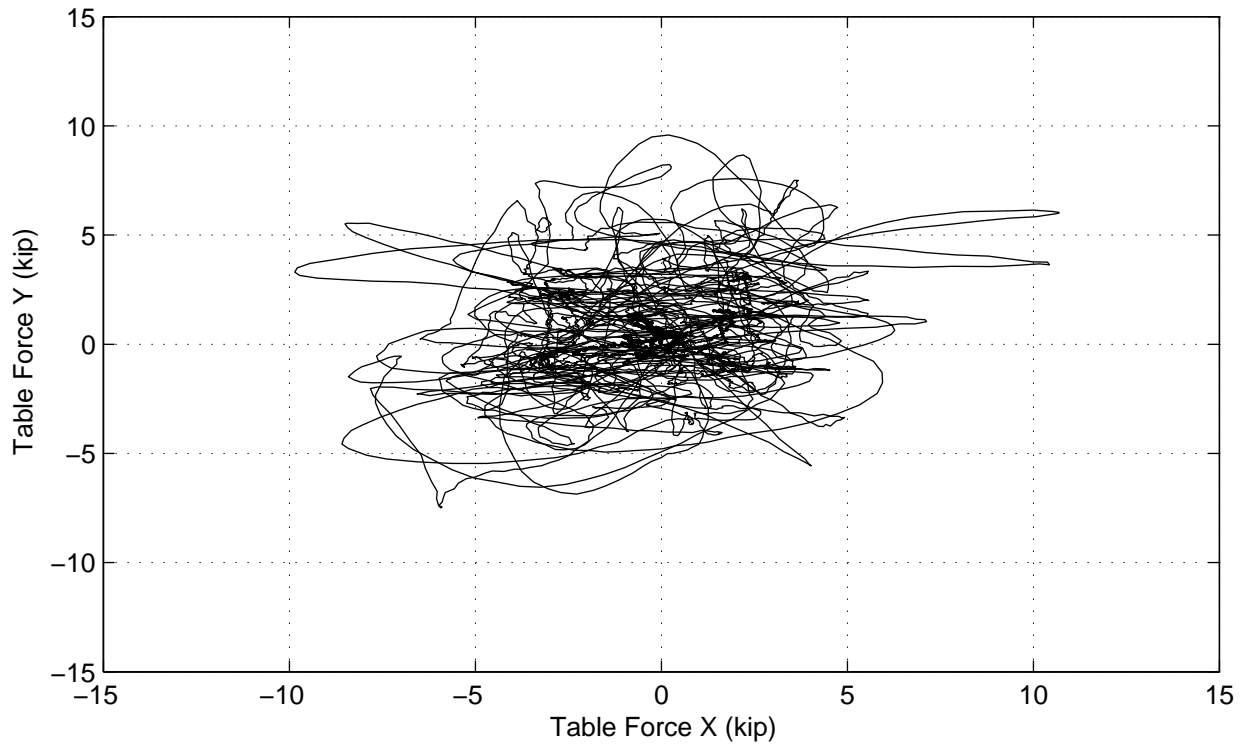
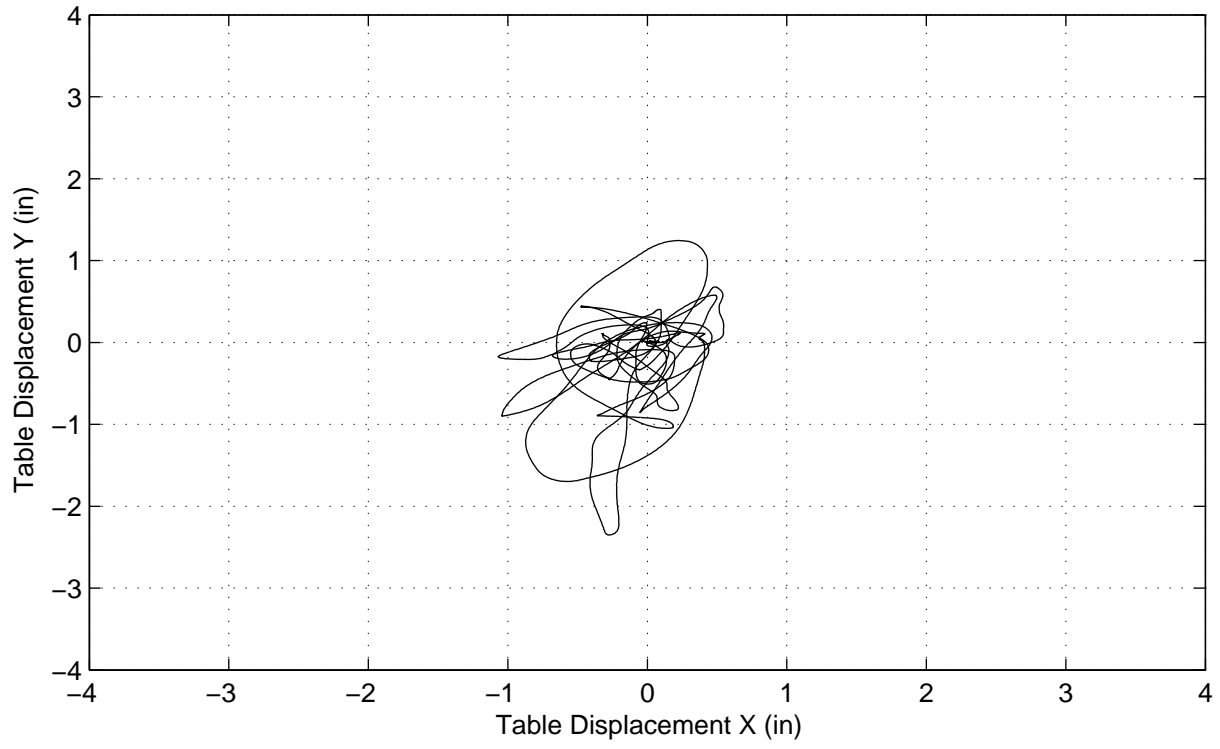

AP4 (No Added Mass) – Test M, 2.5in. Long Period DBE – 0 deg Trans

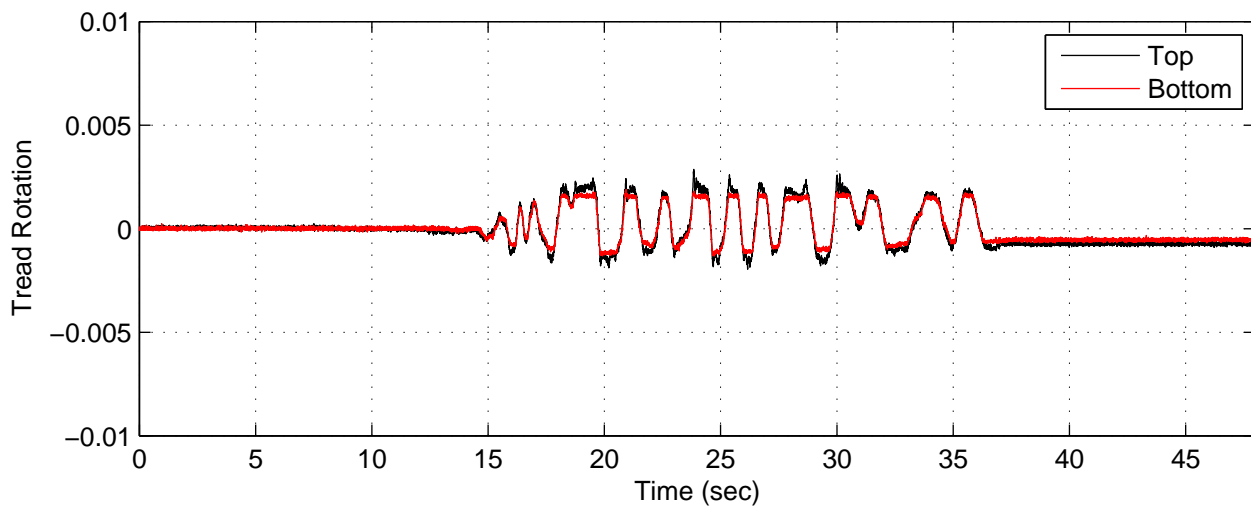
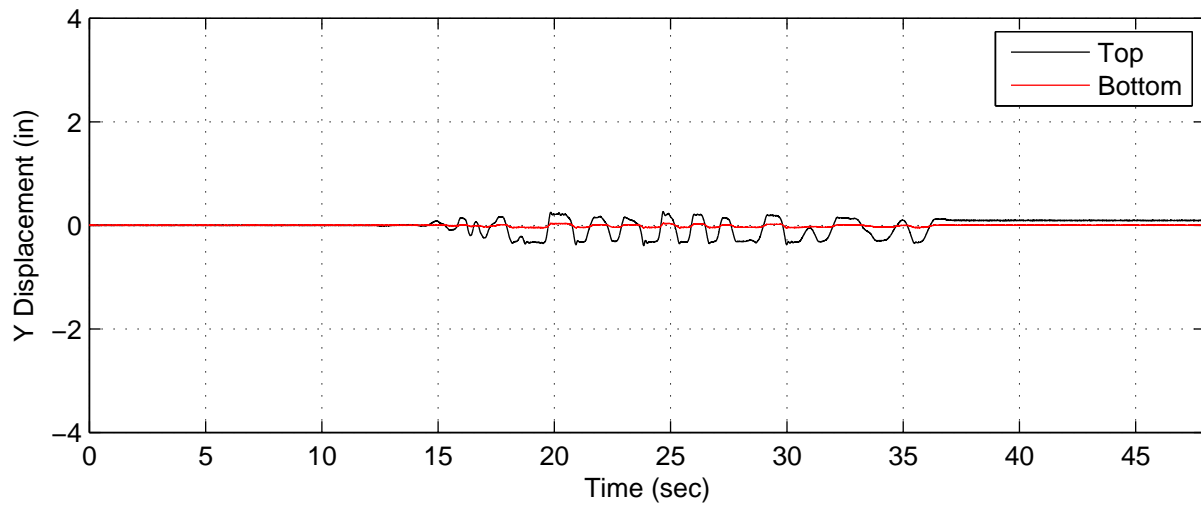
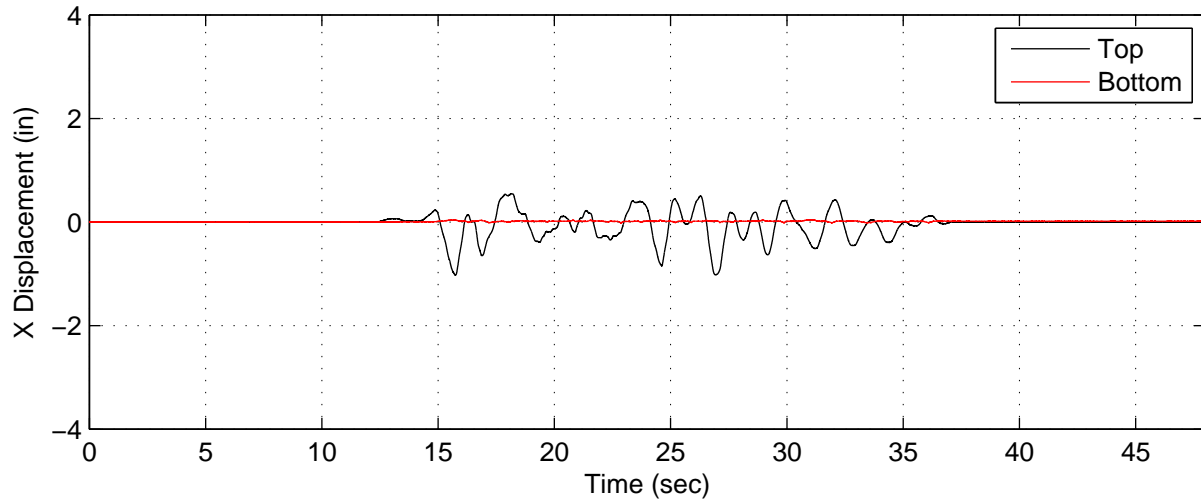

AP4 (No Added Mass) – Test M, 2.5in. Long Period DBE – 0 deg Trans

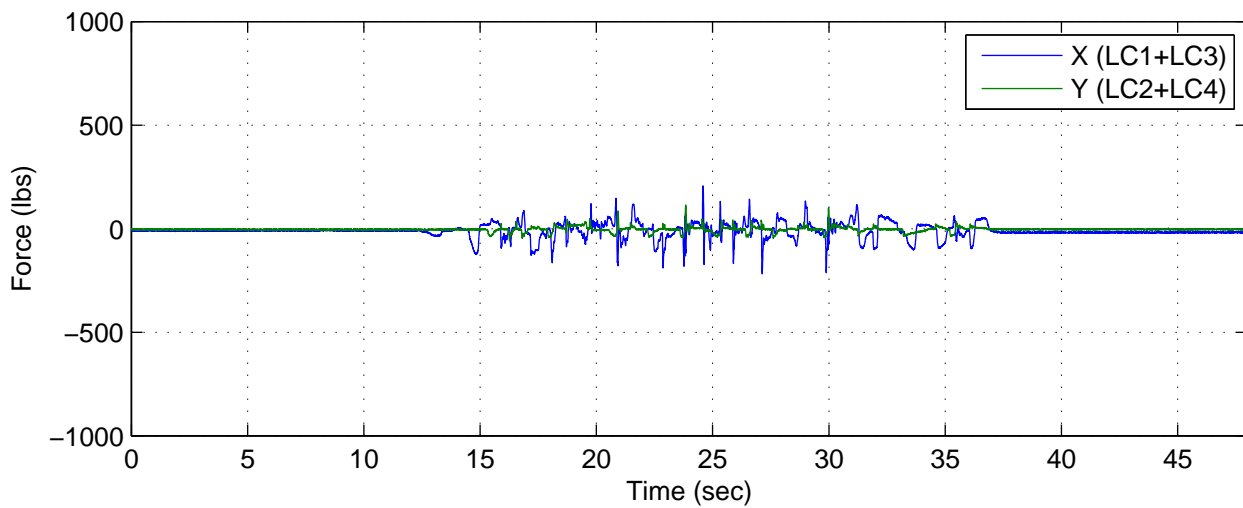
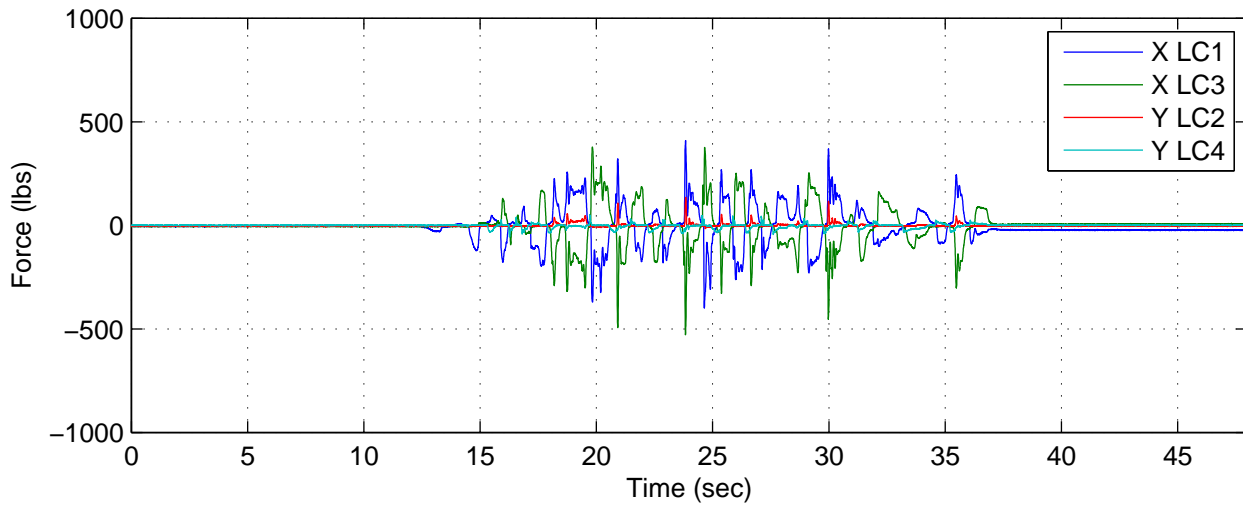
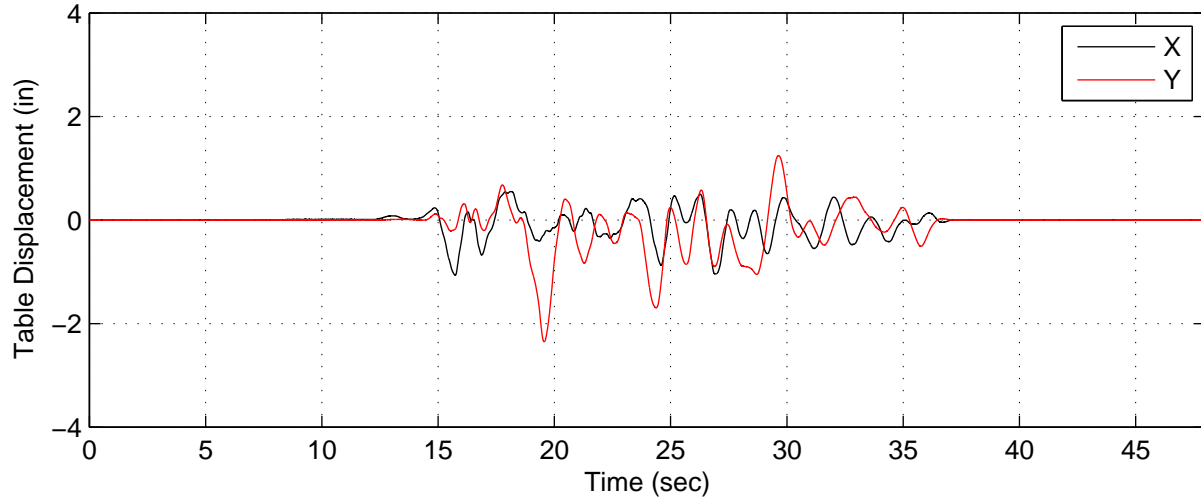



AP4 (No Added Mass) – Test M, 2.5in. Long Period DBE – 0 deg Trans

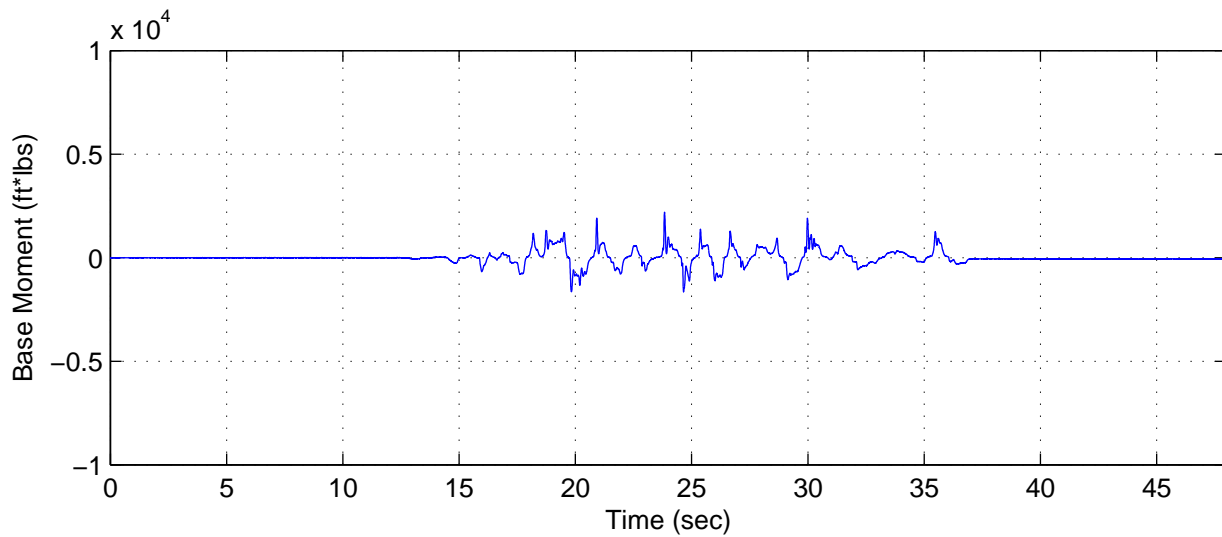
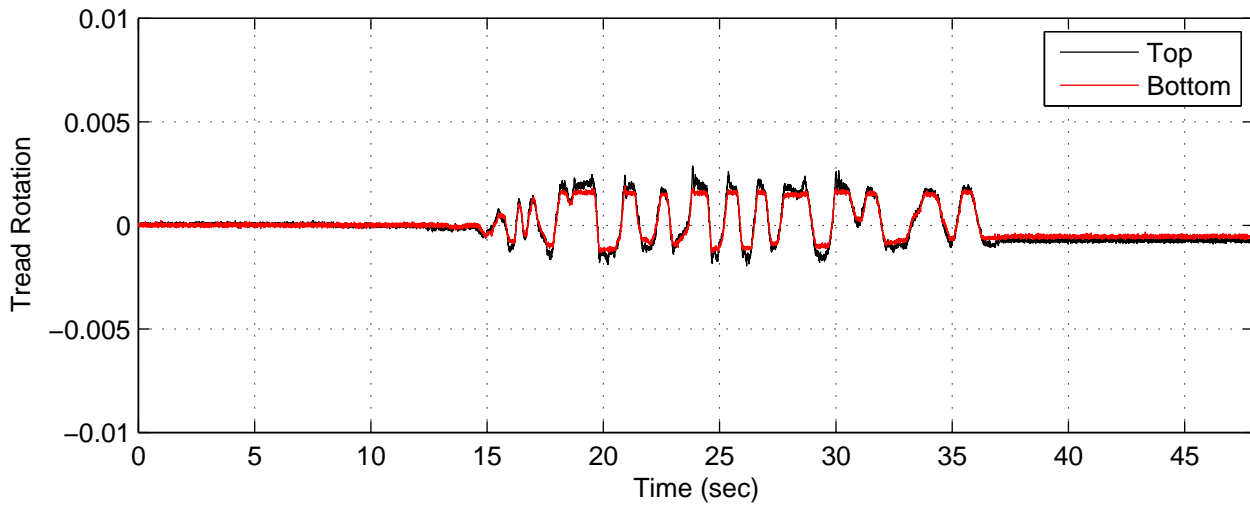
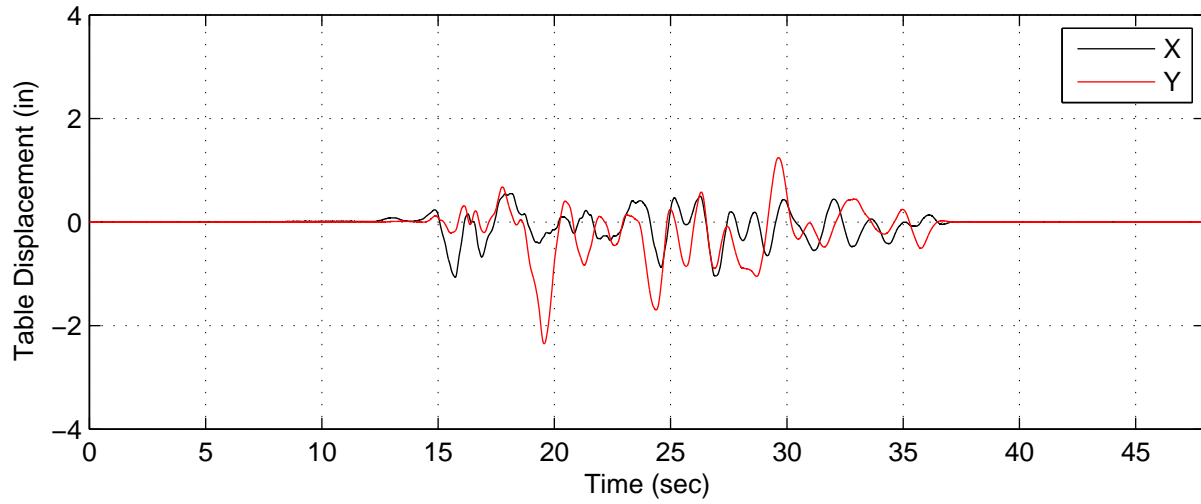

AP4 (No Added Mass) – Test N, 2.5in. Newhall DBE – 0 deg Long

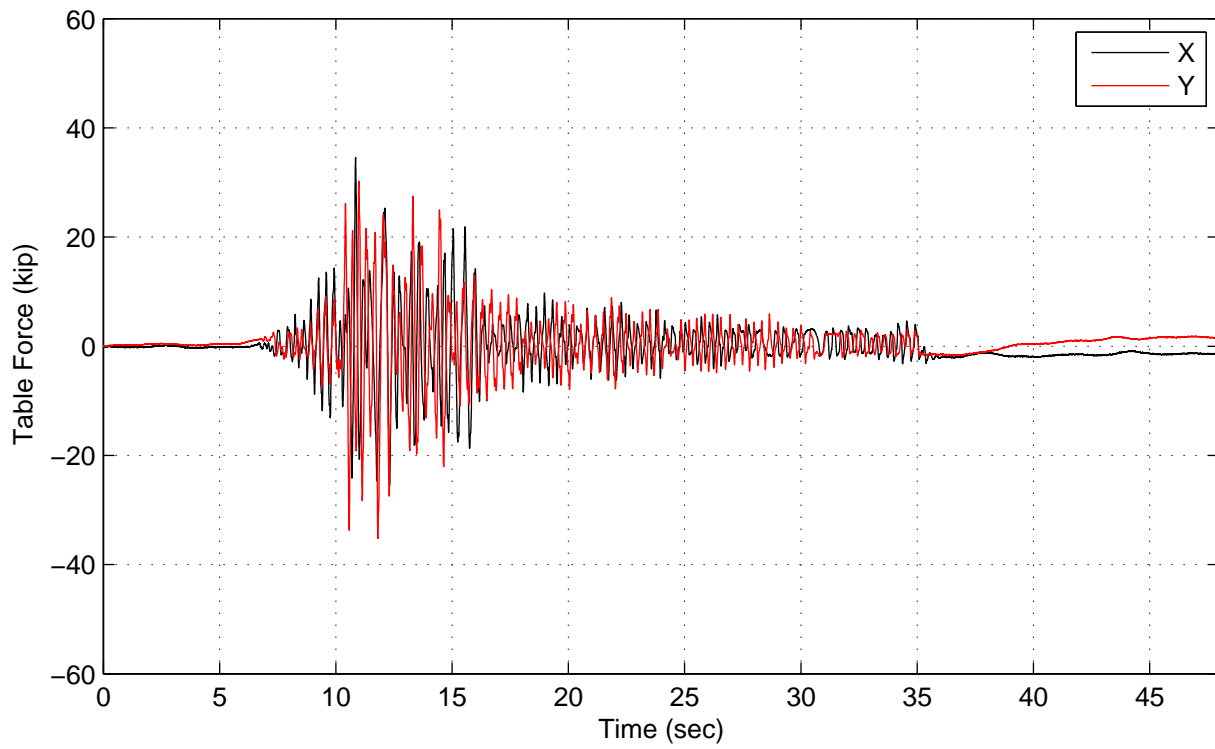
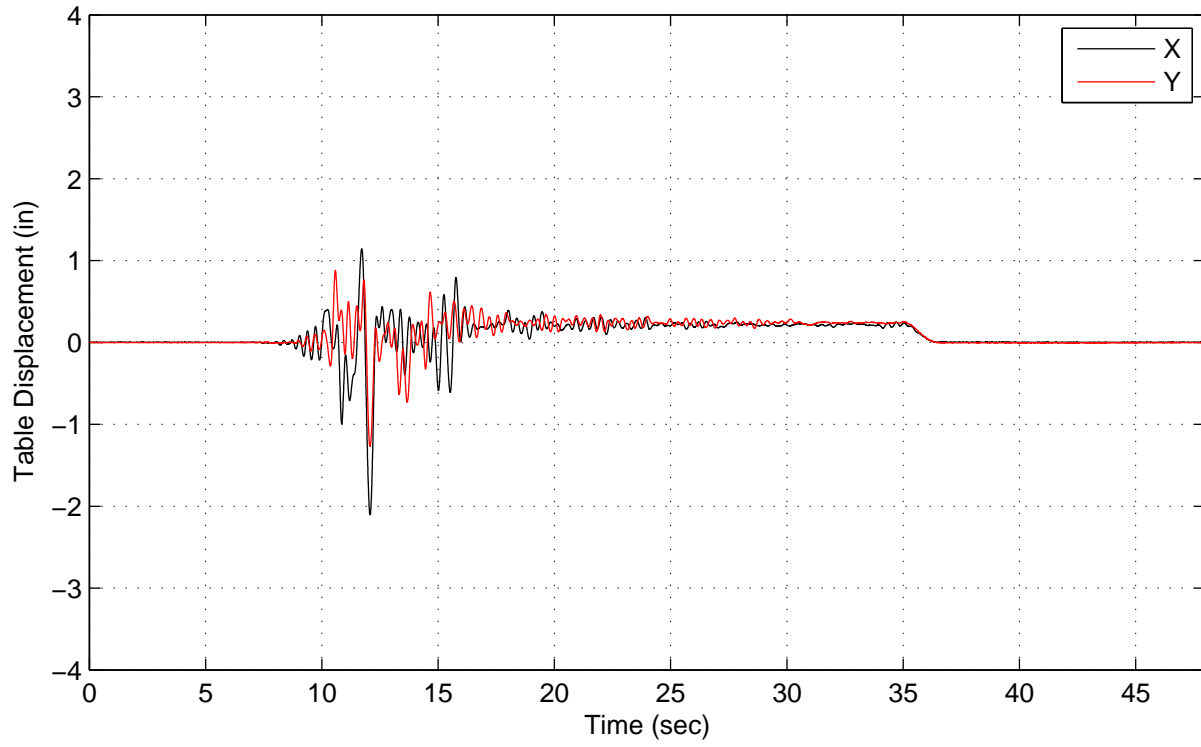

AP4 (No Added Mass) – Test N, 2.5in. Newhall DBE – 0 deg Long

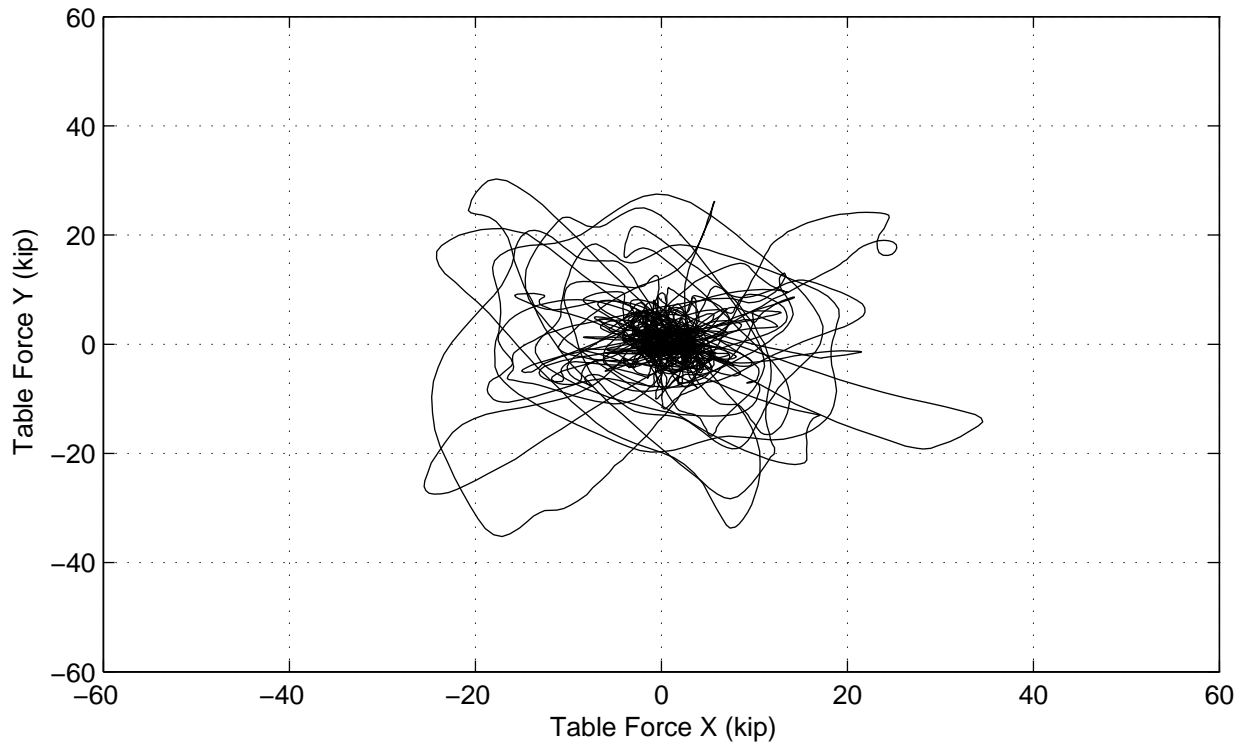
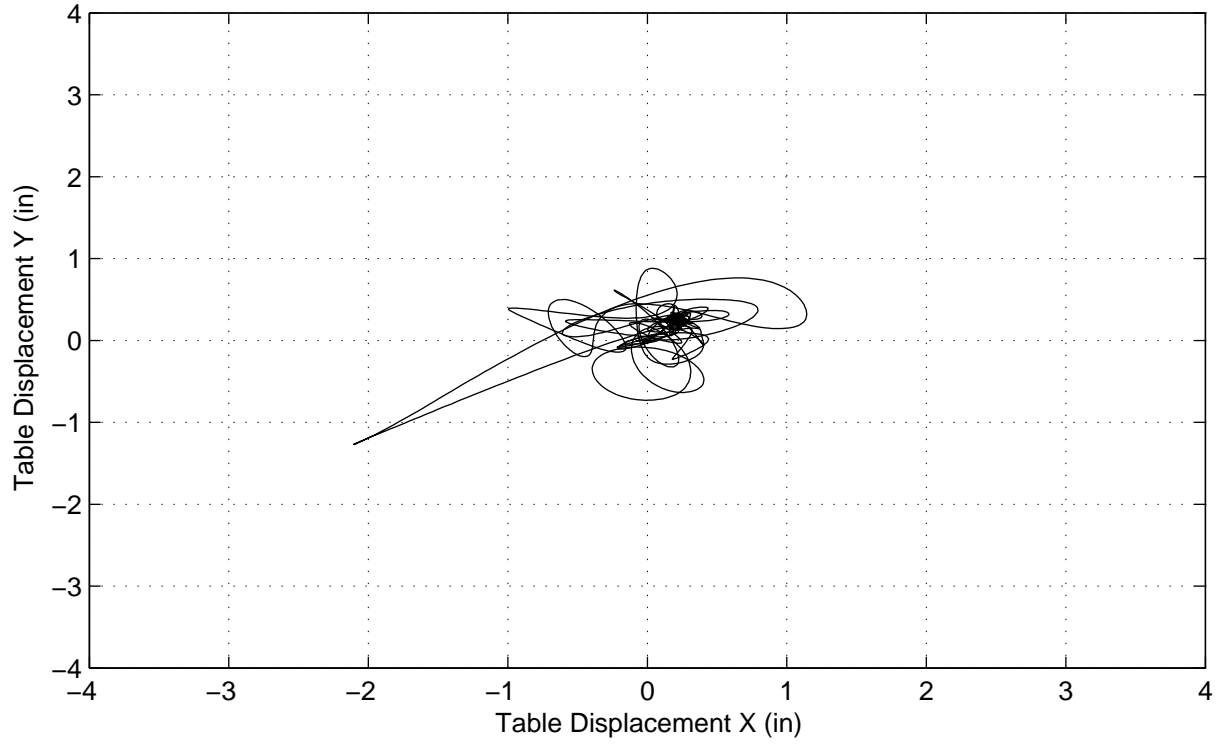

AP4 (No Added Mass) – Test N, 2.5in. Newhall DBE – 0 deg Long

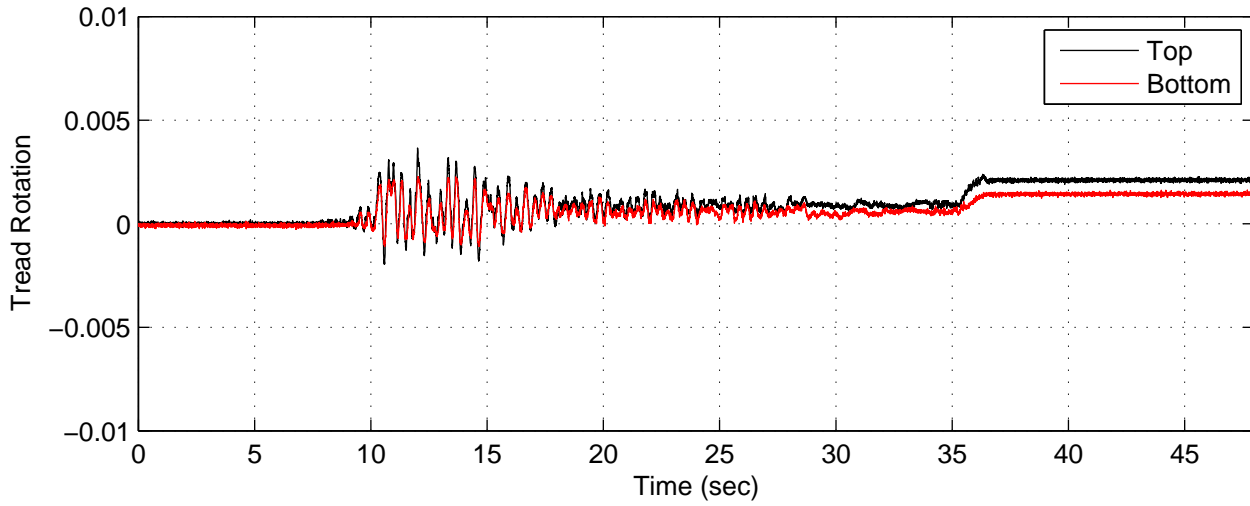
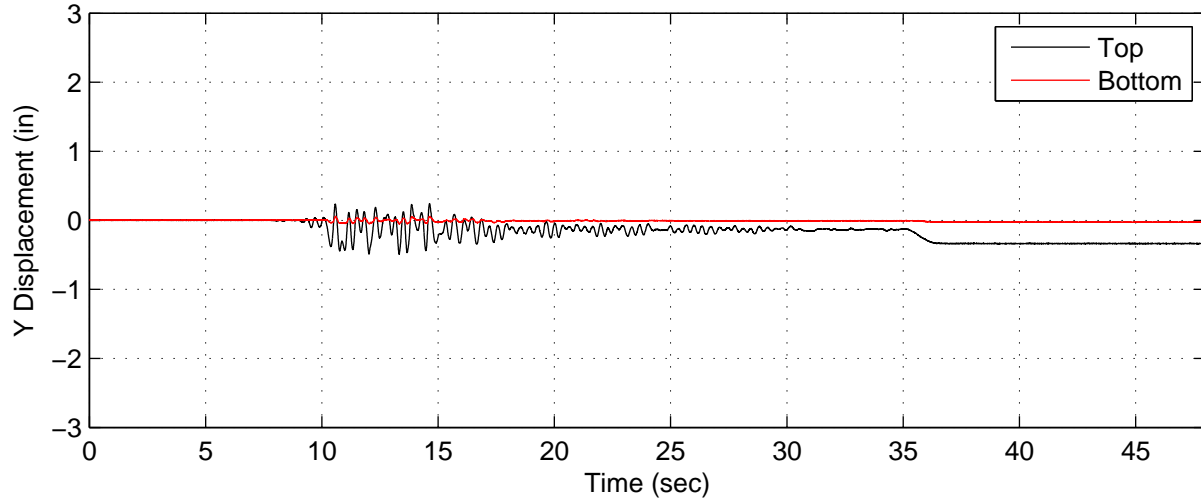
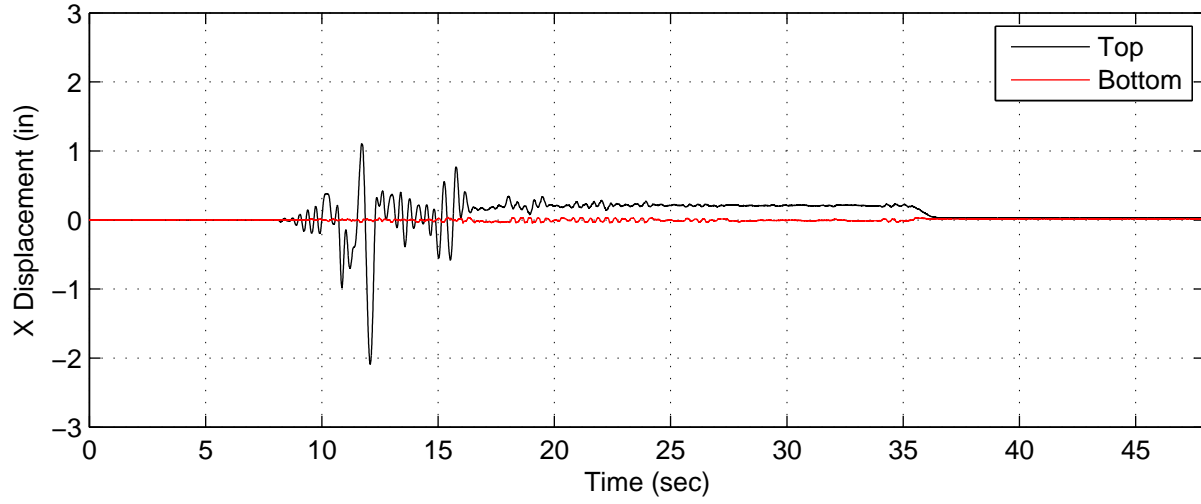

AP4 (No Added Mass) – Test N, 2.5in. Newhall DBE – 0 deg Long

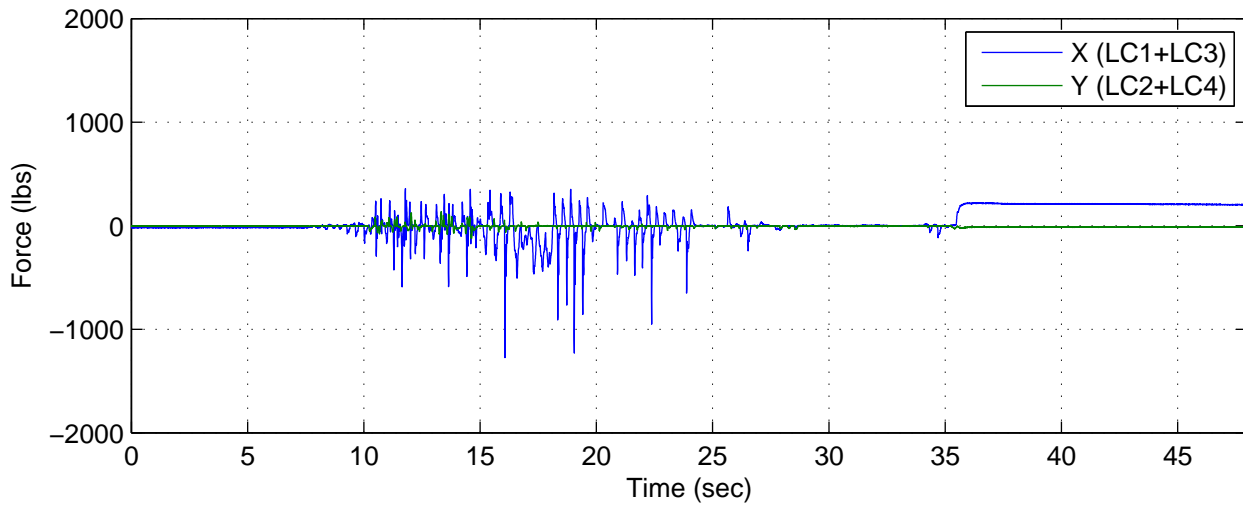
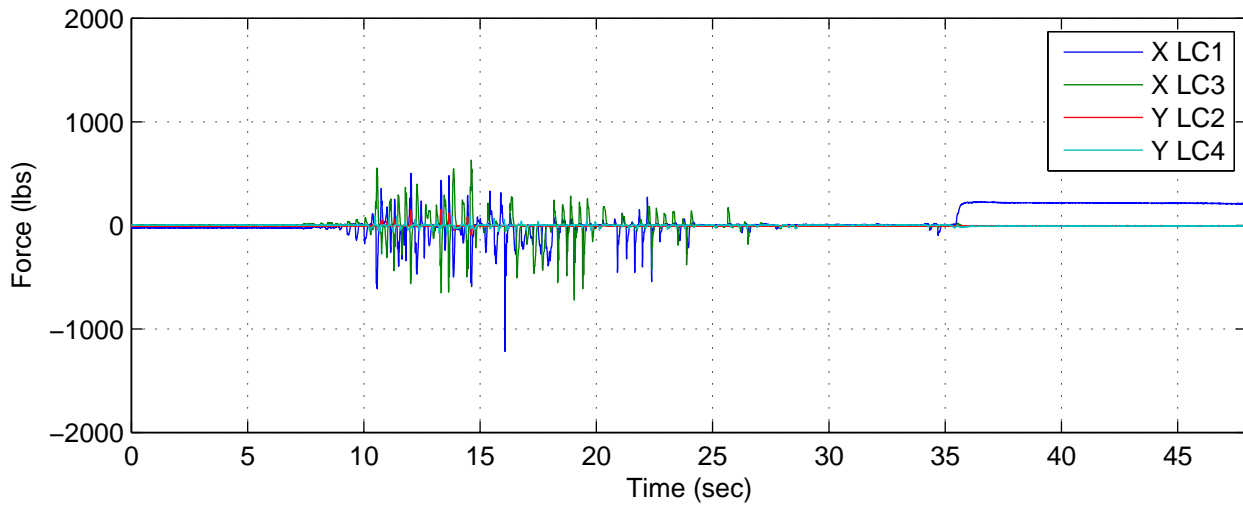
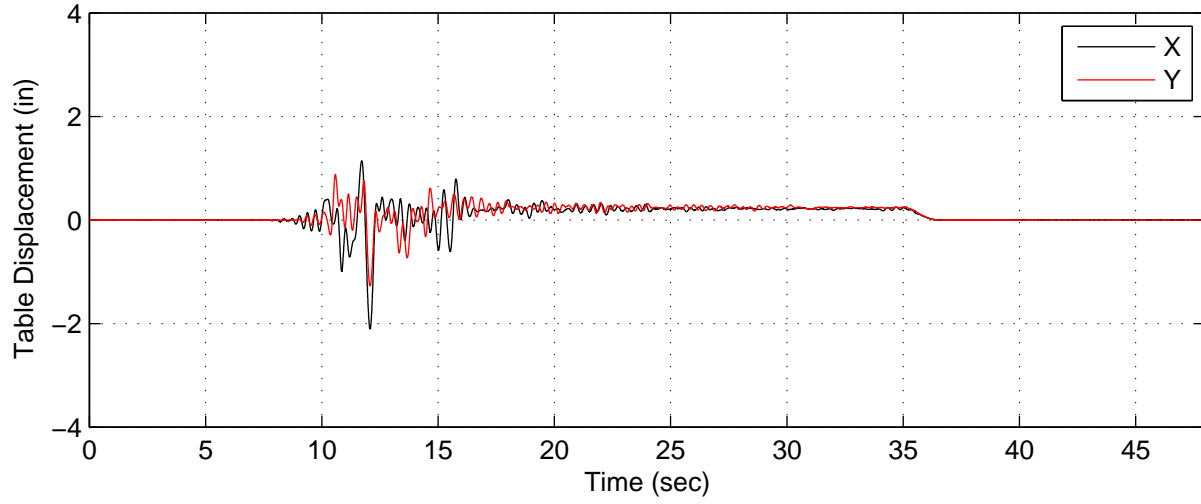

AP4 (No Added Mass) – Test N, 2.5in. Newhall DBE – 0 deg Long

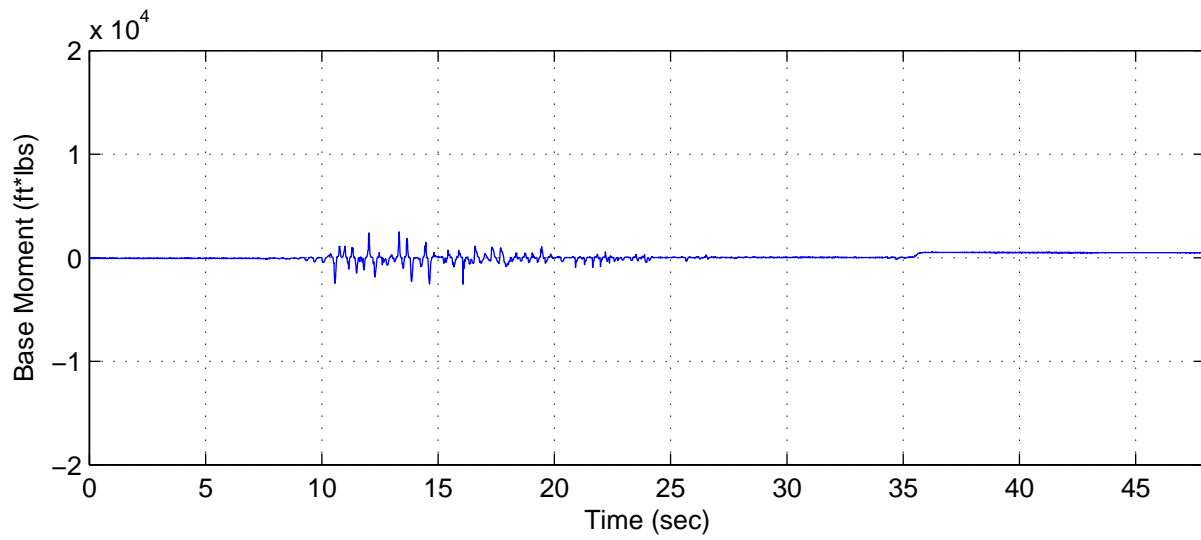
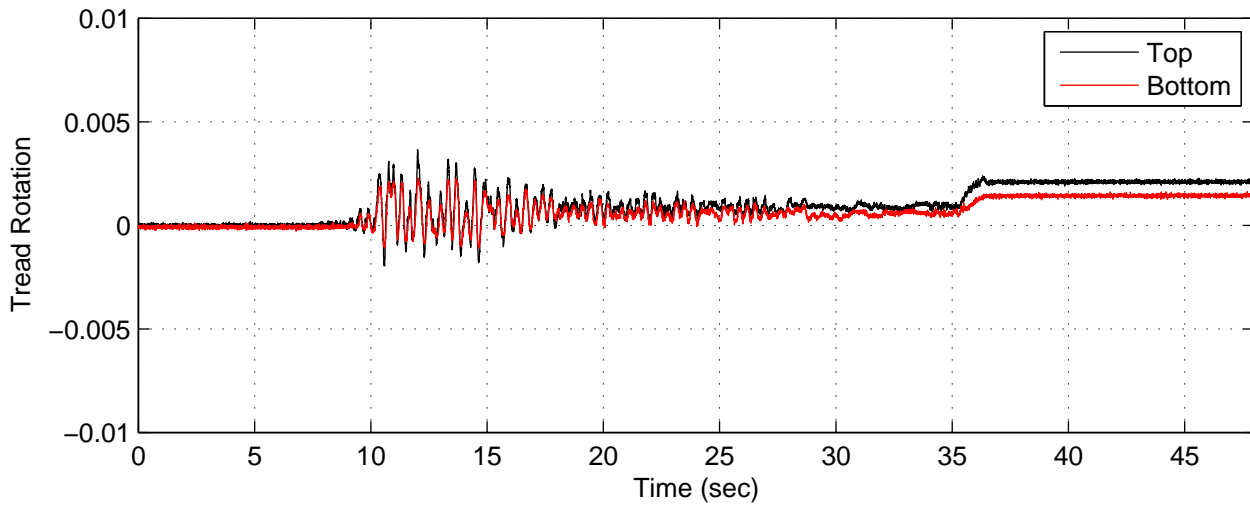
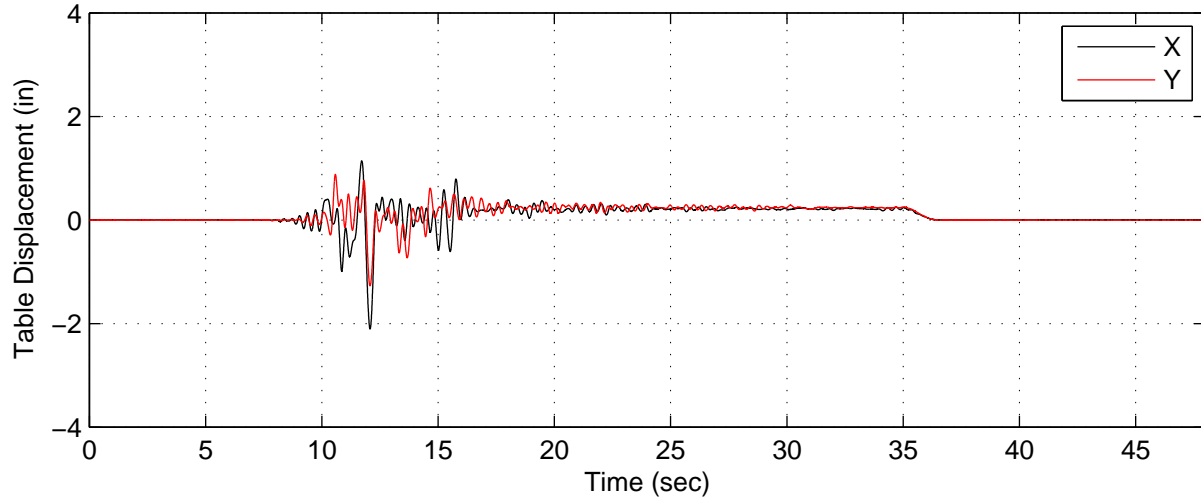

AP4 (No Added Mass) – Test O, 2.5in. Newhall DBE – 0 deg Trans

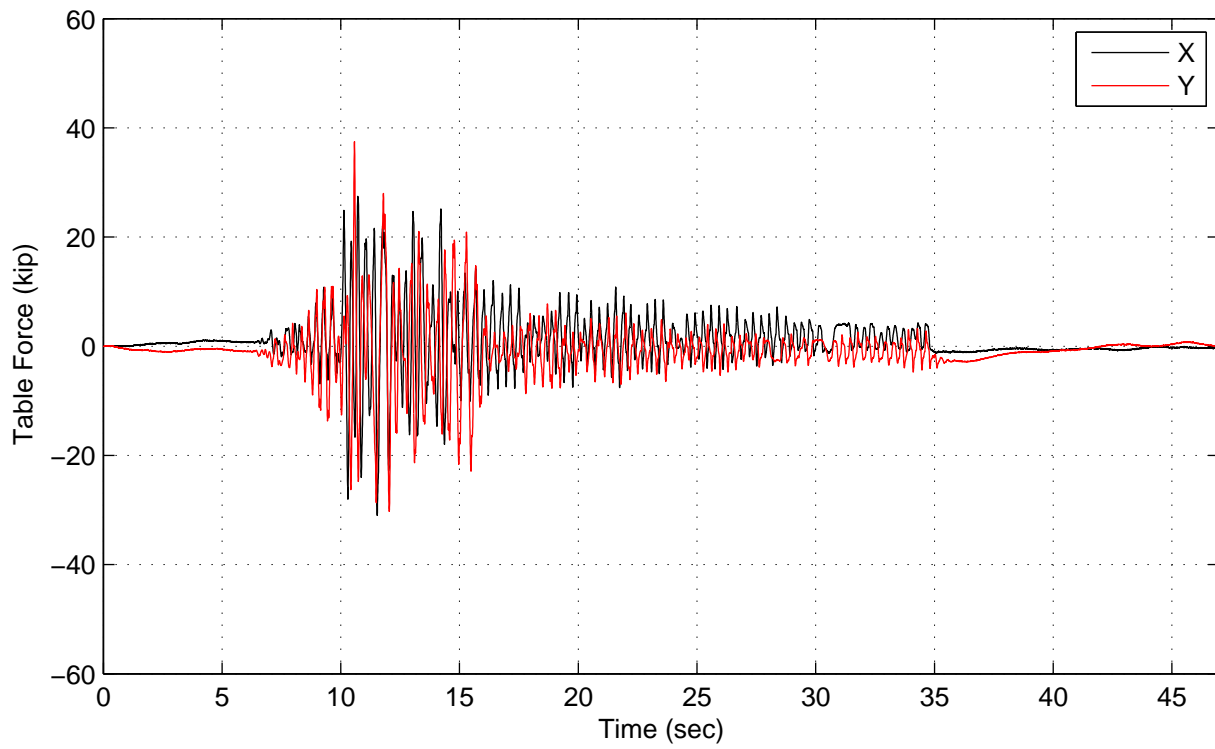
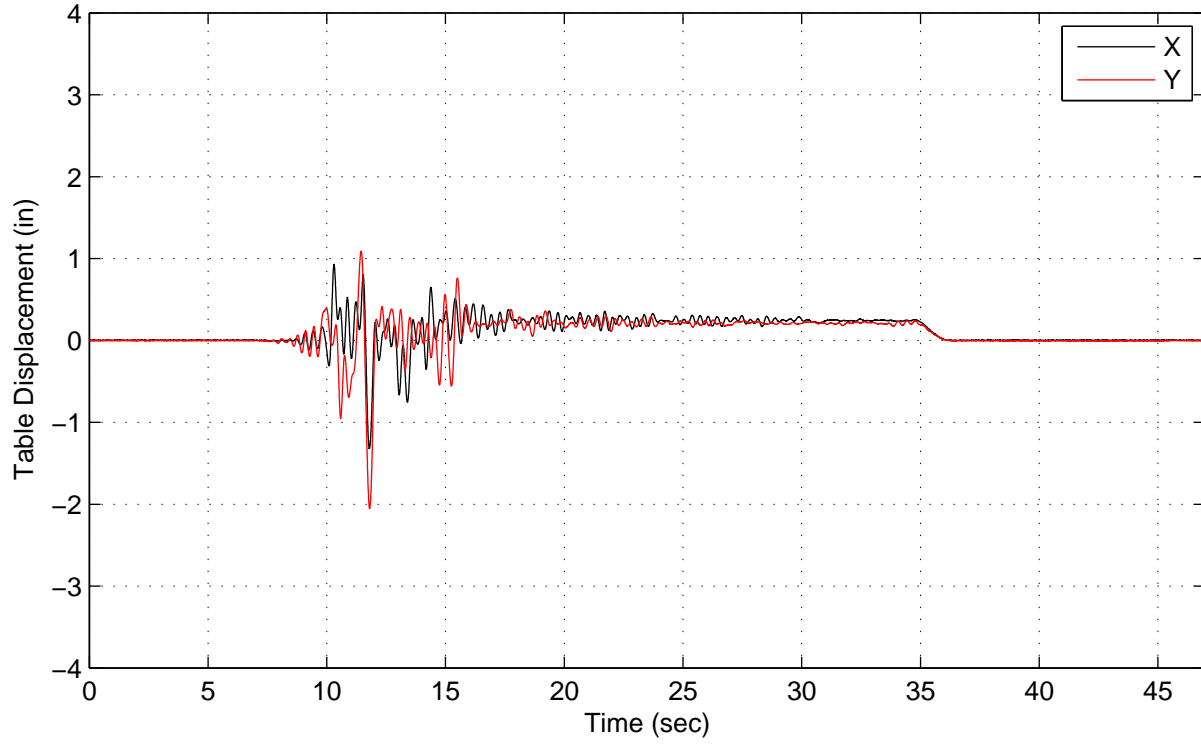

AP4 (No Added Mass) – Test O, 2.5in. Newhall DBE – 0 deg Trans

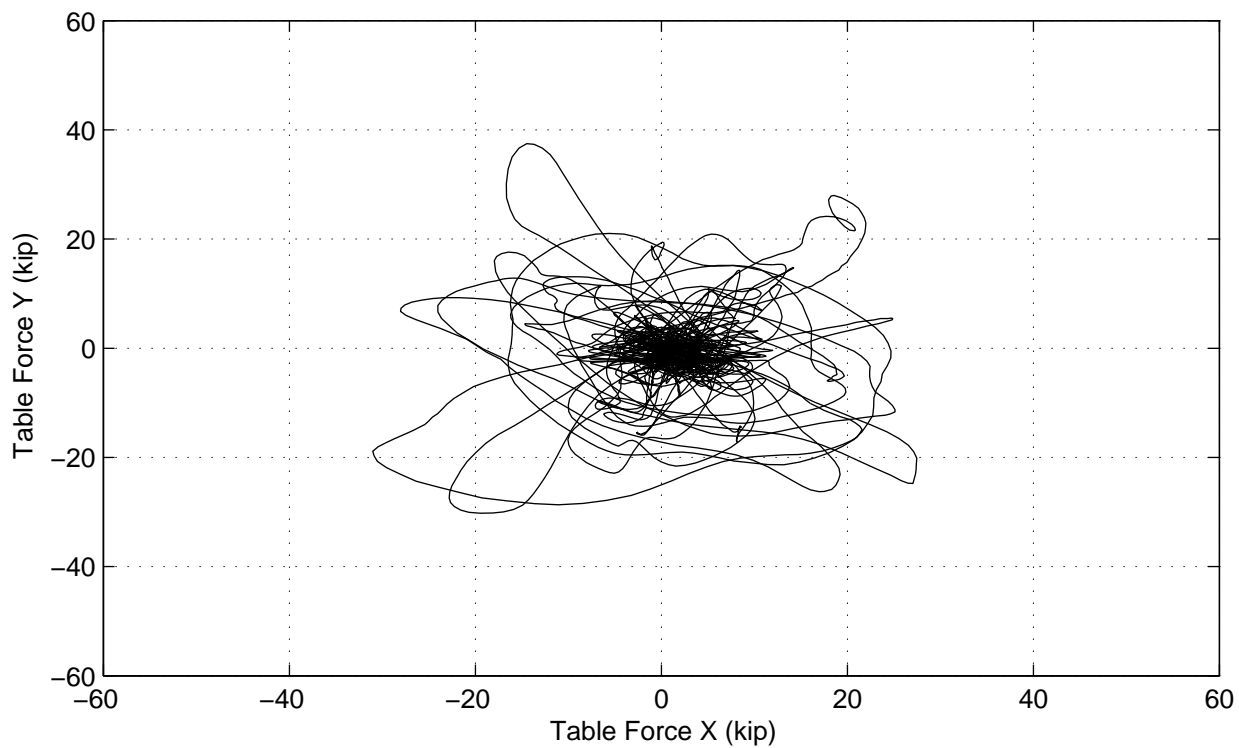
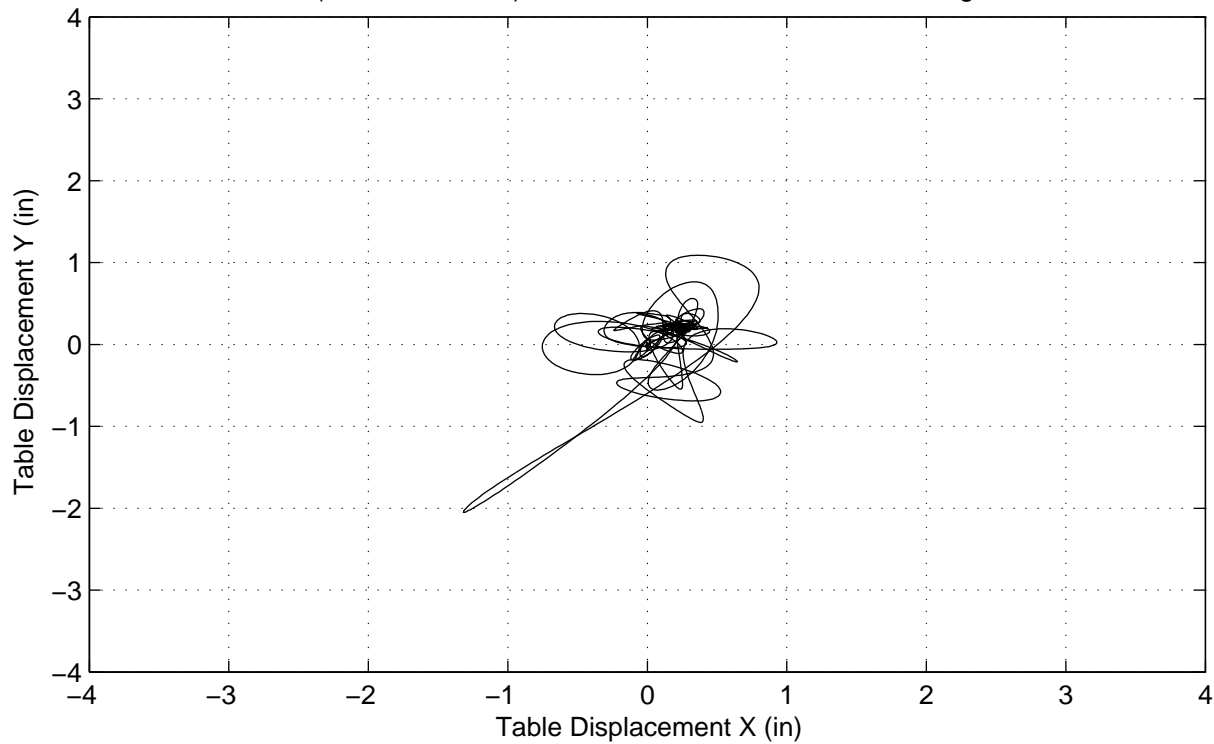



AP4 (No Added Mass) – Test O, 2.5in. Newhall DBE – 0 deg Trans

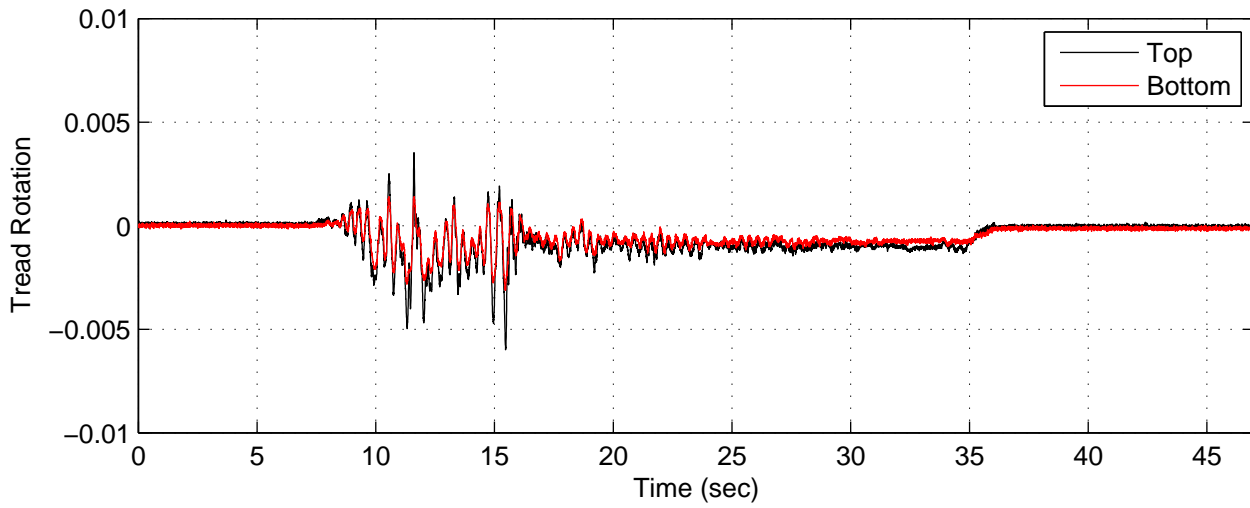
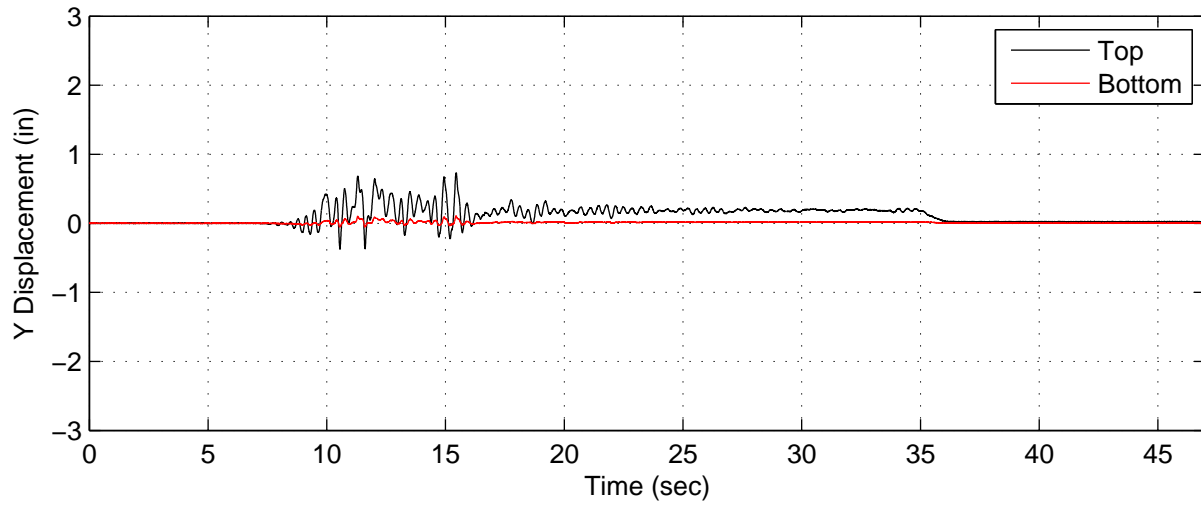
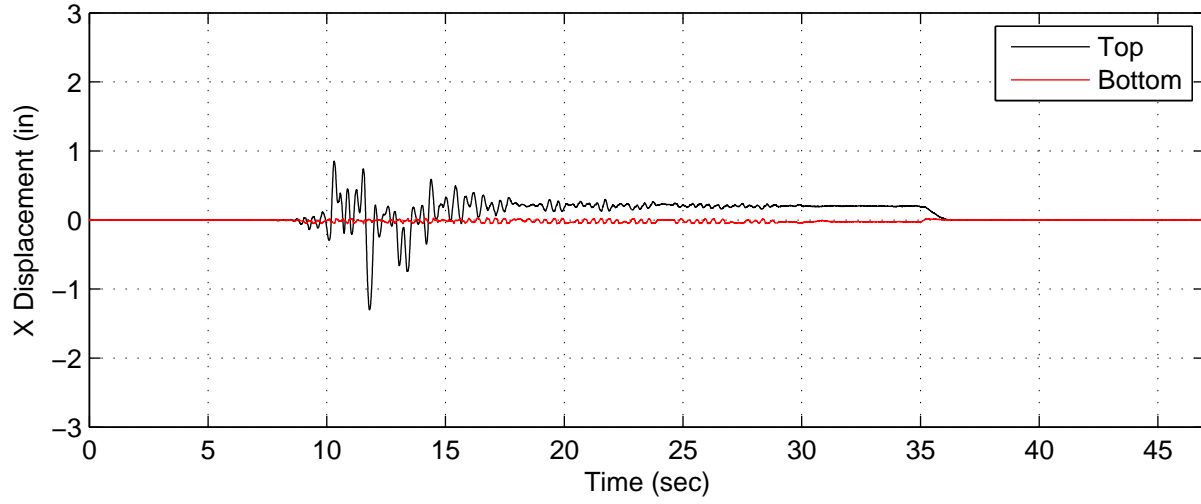

AP4 (No Added Mass) – Test O, 2.5in. Newhall DBE – 0 deg Trans

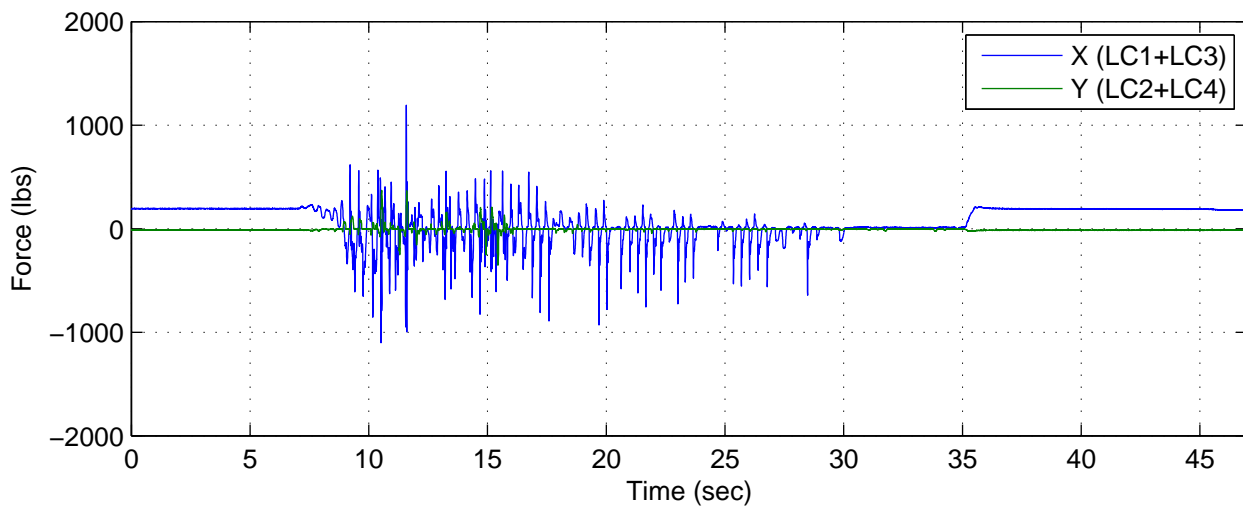
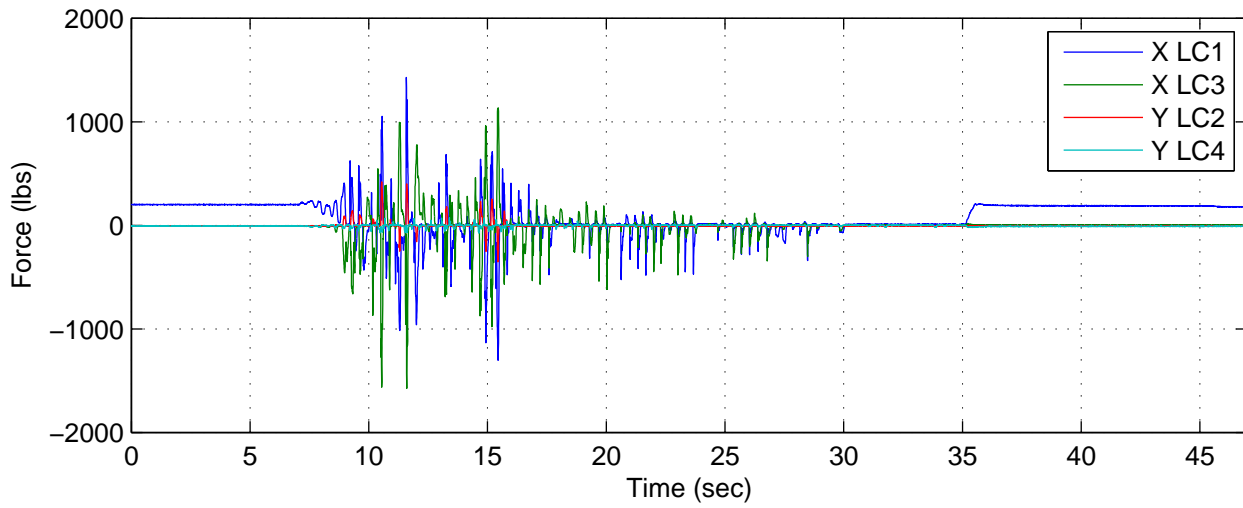
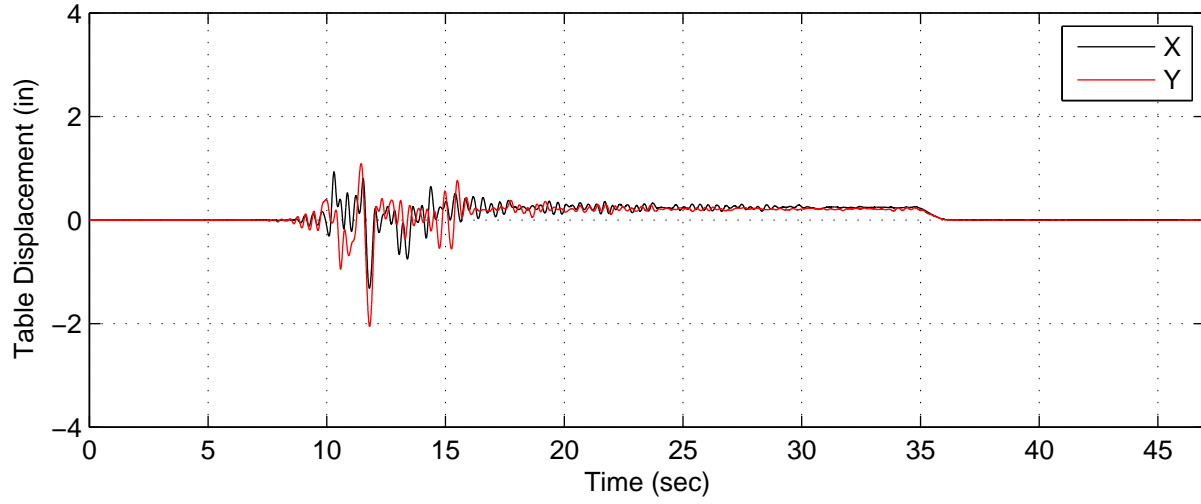

AP4 (No Added Mass) – Test O, 2.5in. Newhall DBE – 0 deg Trans

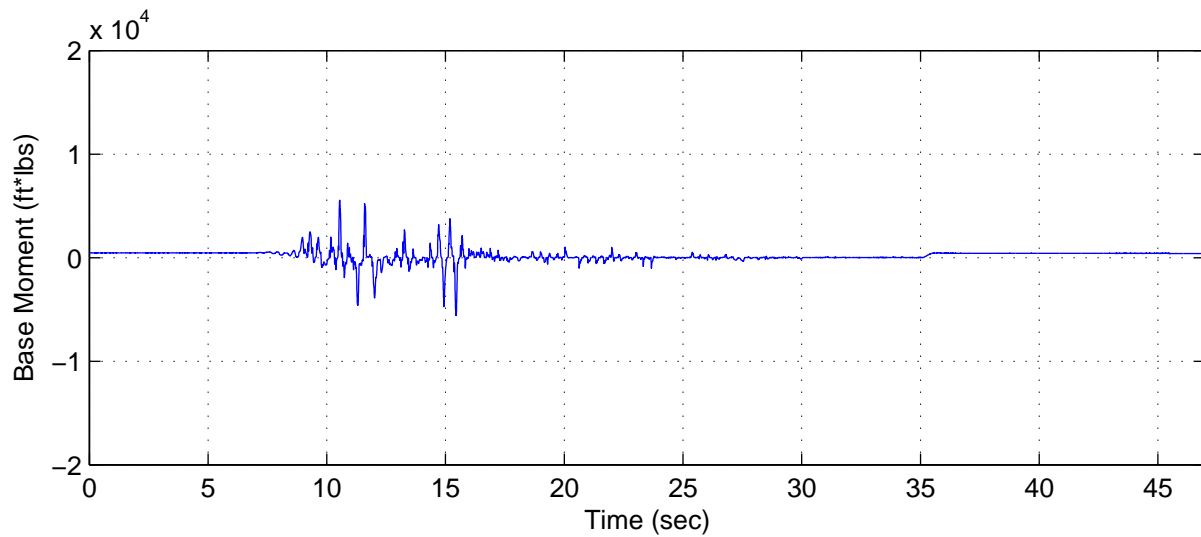
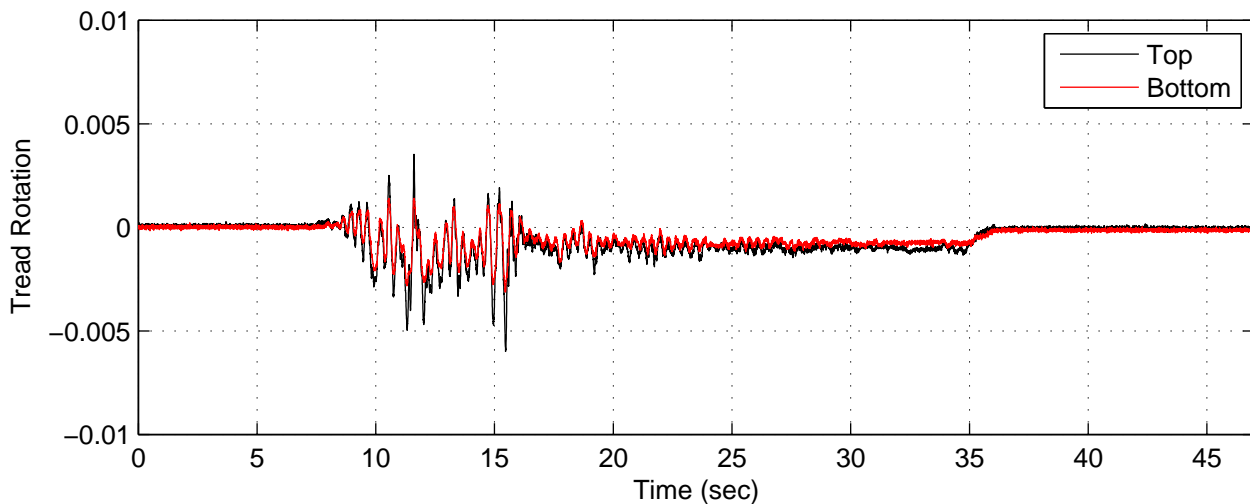
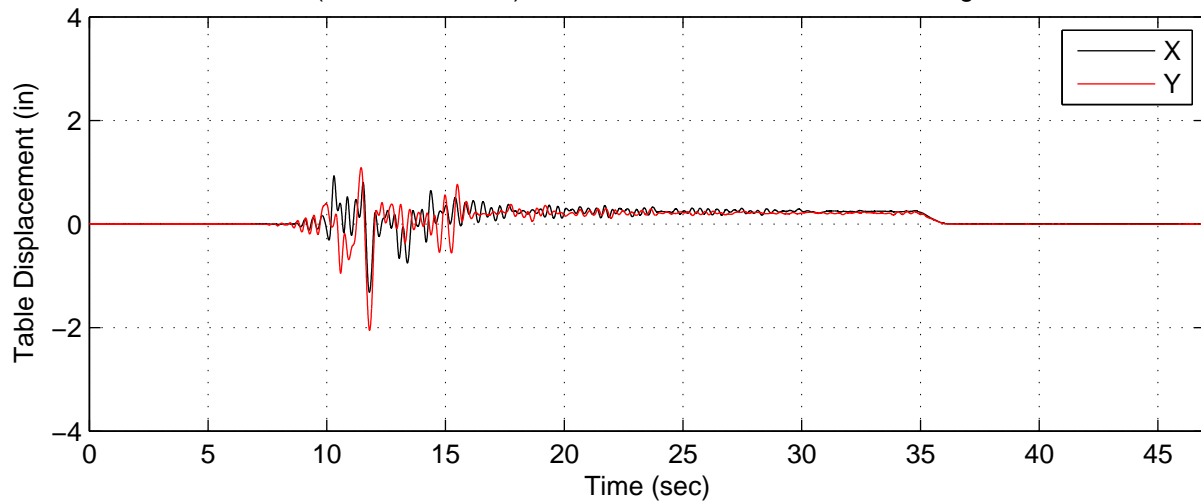

AP4 (No Added Mass) – Test P, 3.75in. Newhall MCE – 0 deg Long

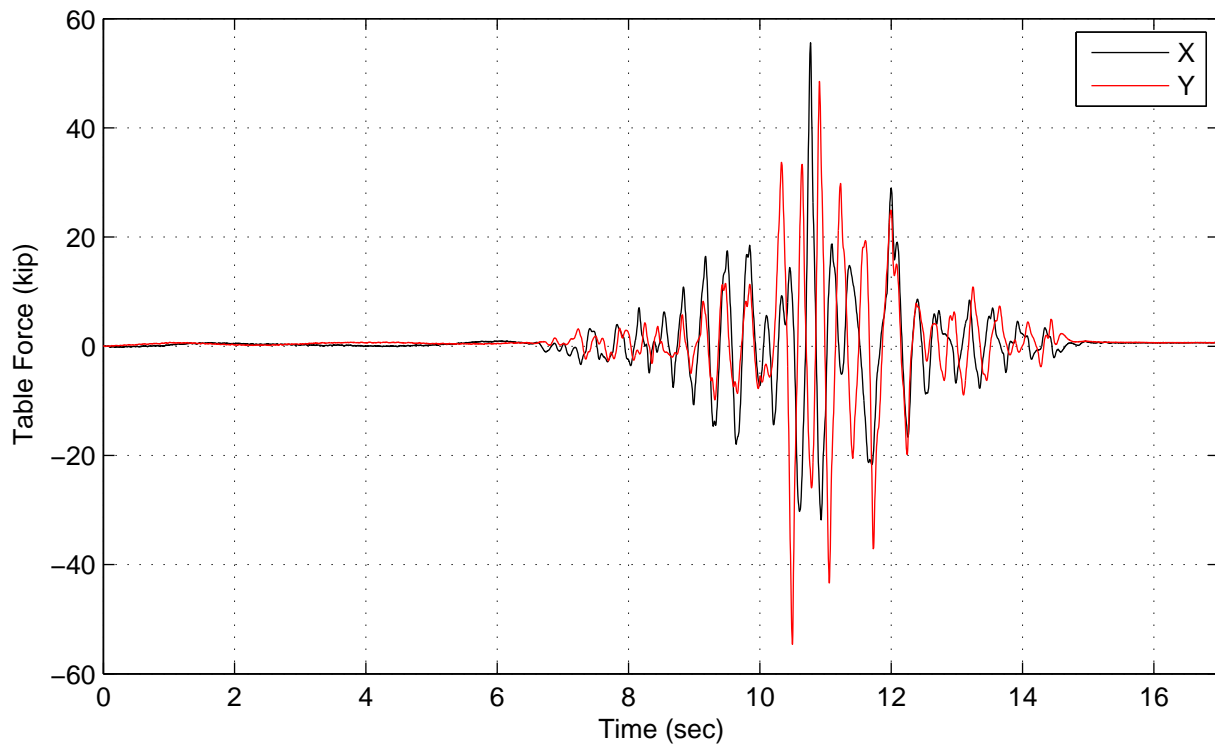
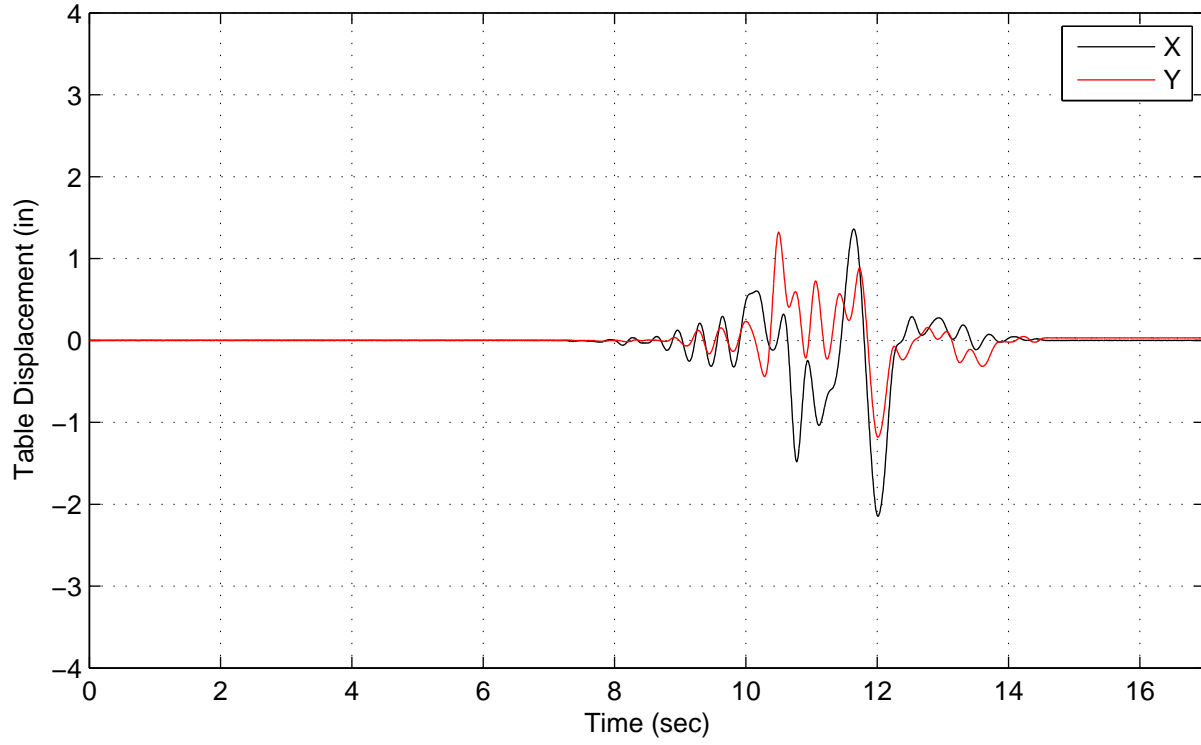

AP4 (No Added Mass) – Test P, 3.75in. Newhall MCE – 0 deg Long

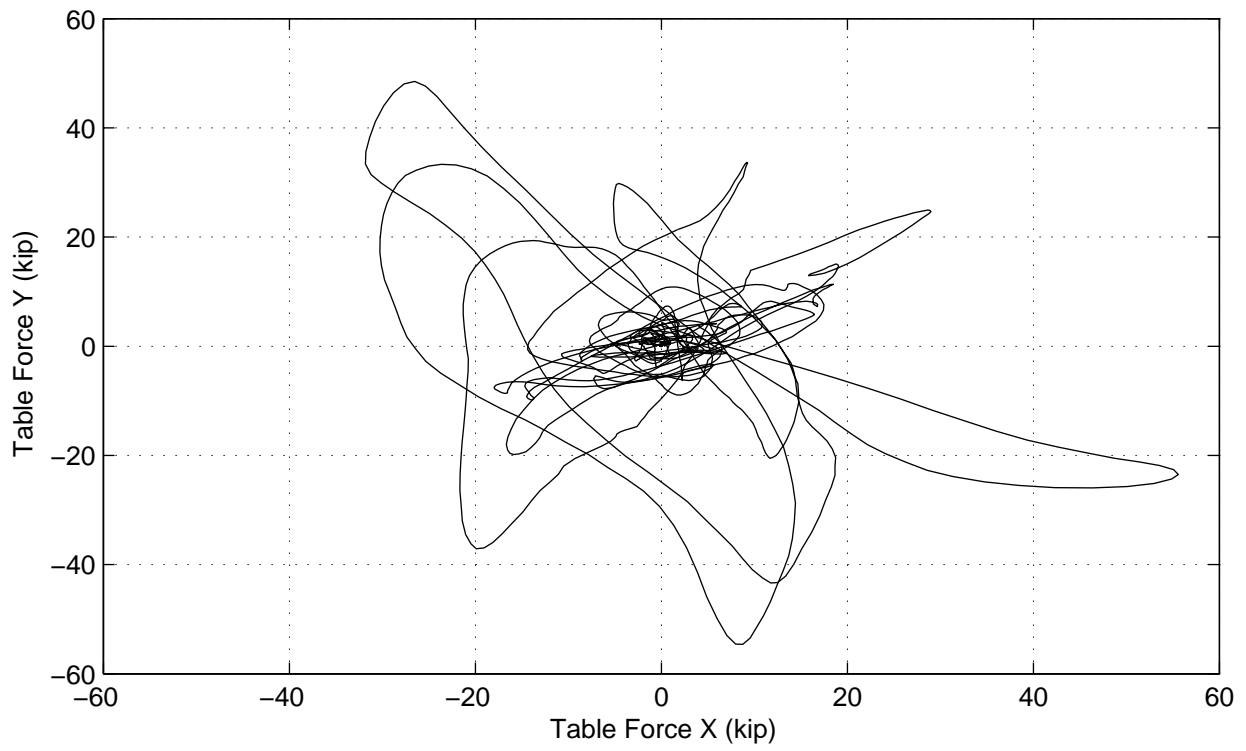
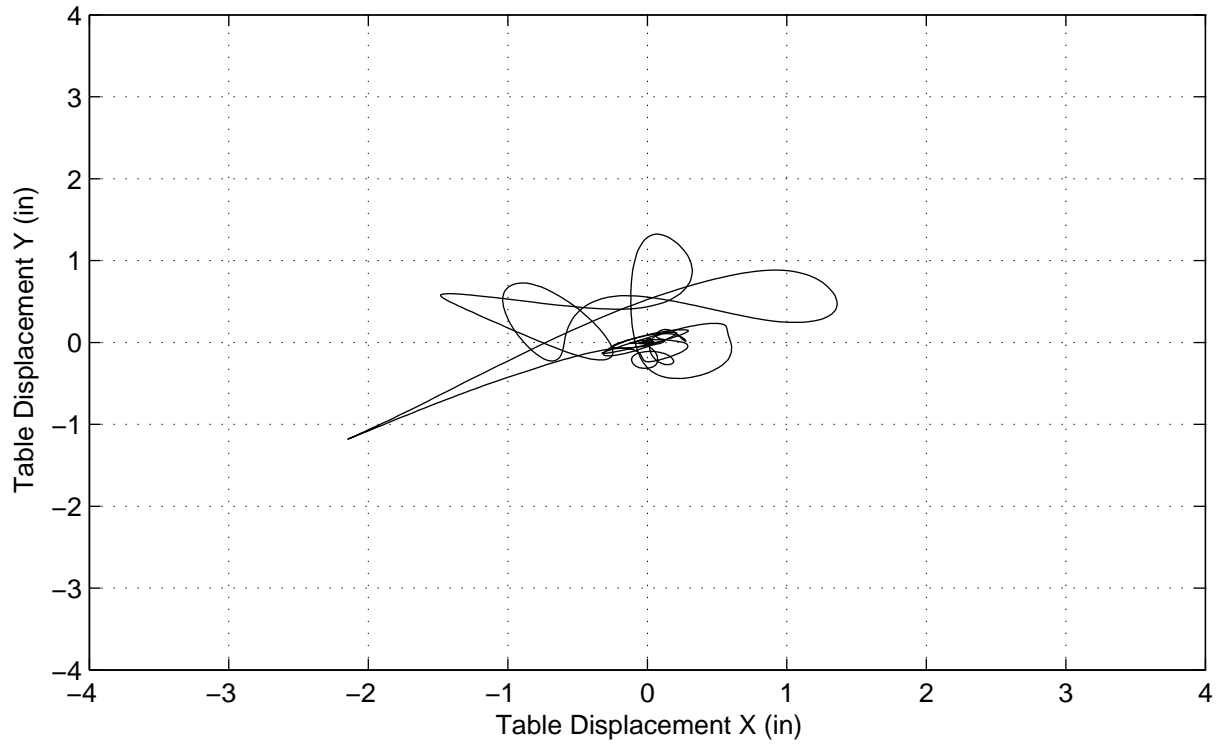

AP4 (No Added Mass) – Test P, 3.75in. Newhall MCE – 0 deg Long

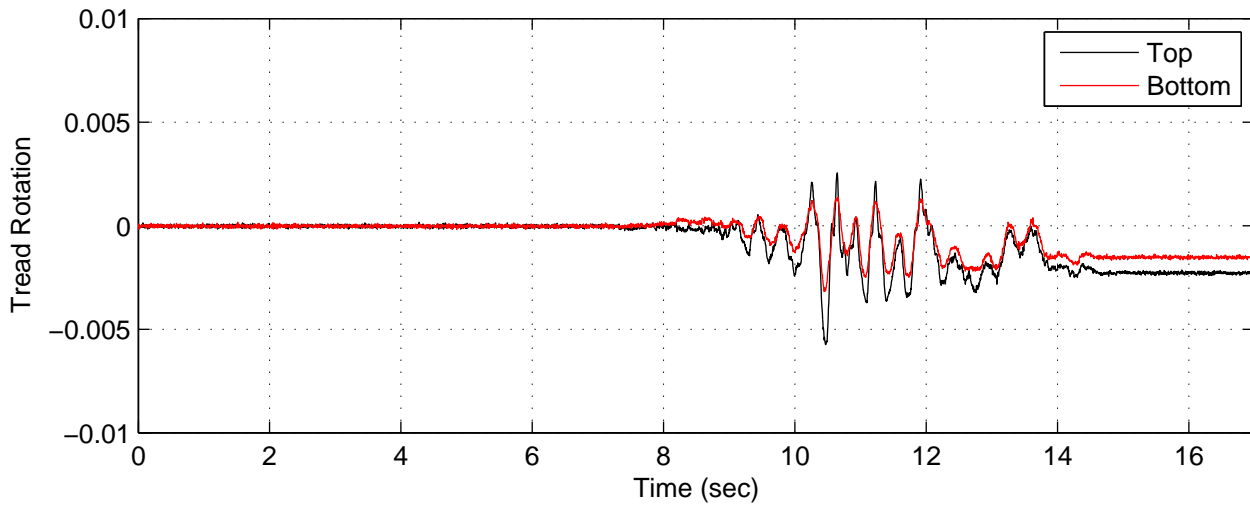
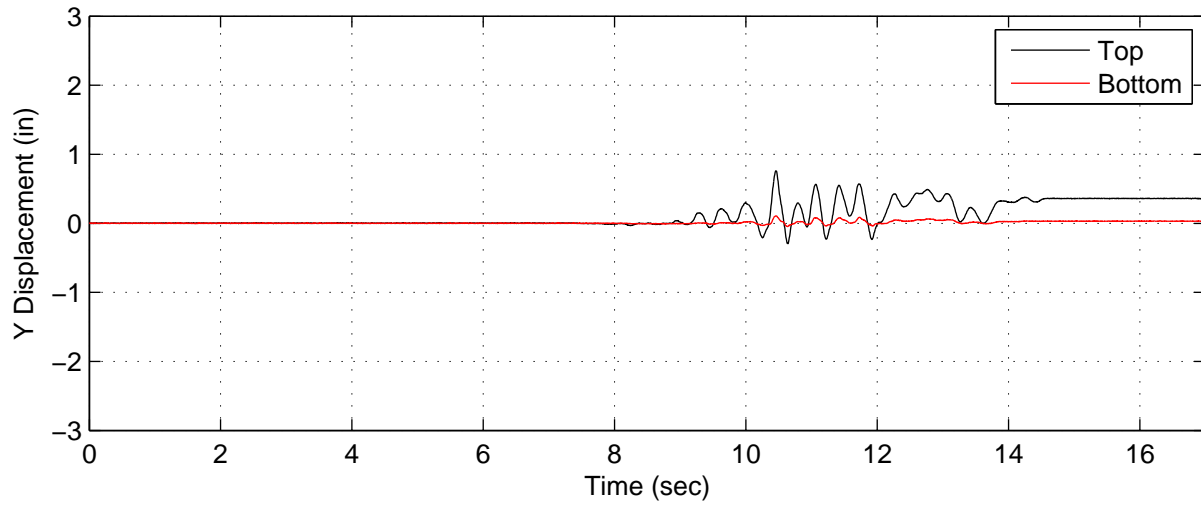
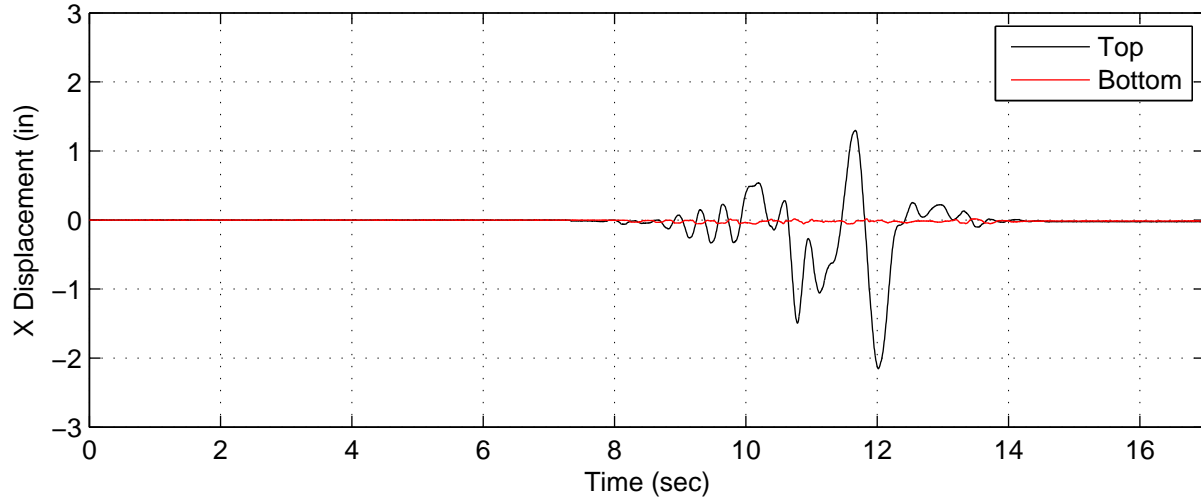

AP4 (No Added Mass) – Test P, 3.75in. Newhall MCE – 0 deg Long

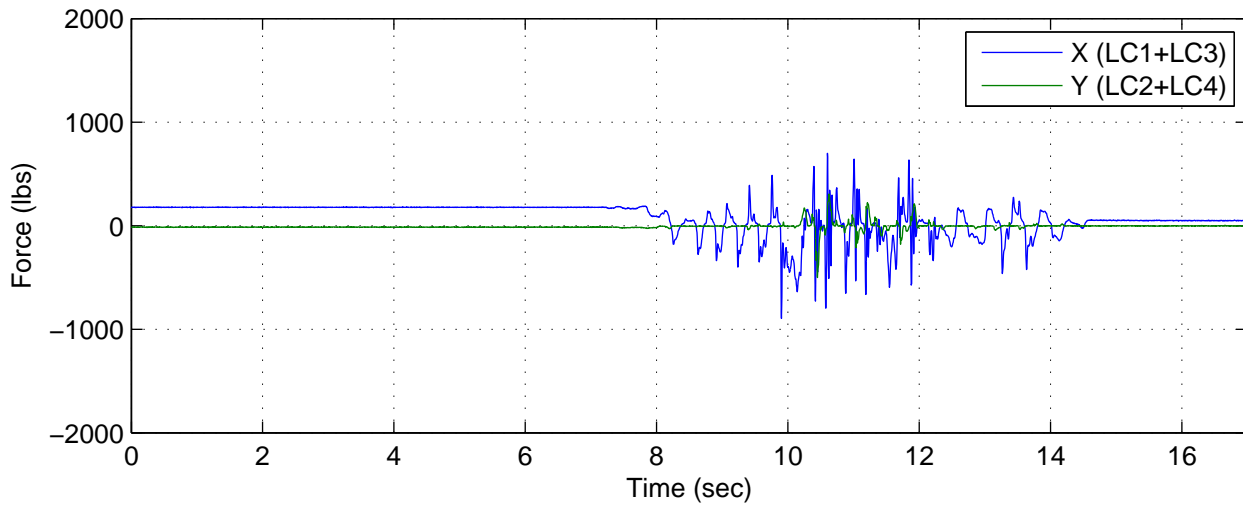
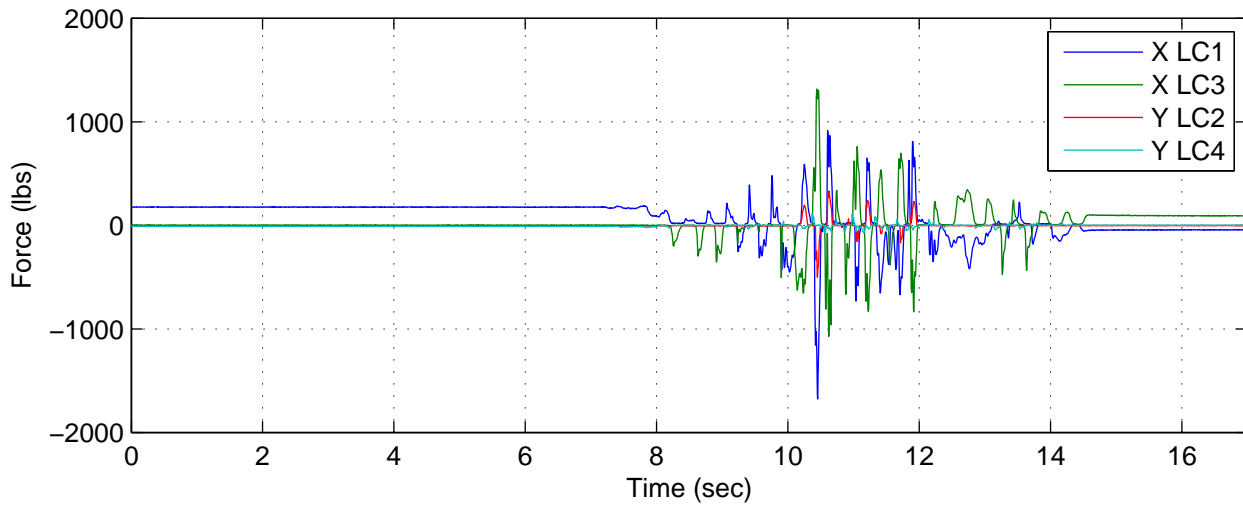
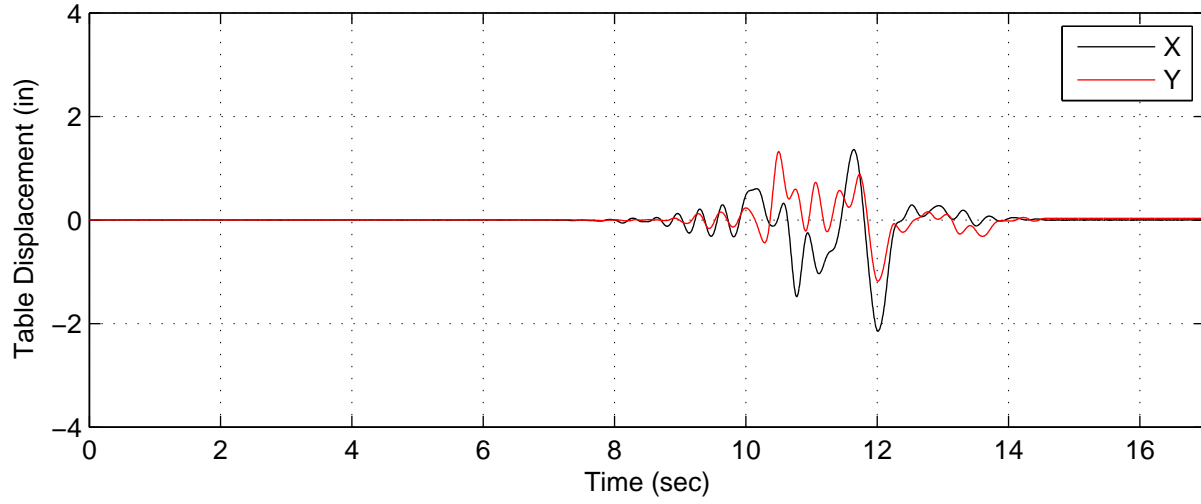

AP4 (No Added Mass) – Test P, 3.75in. Newhall MCE – 0 deg Long

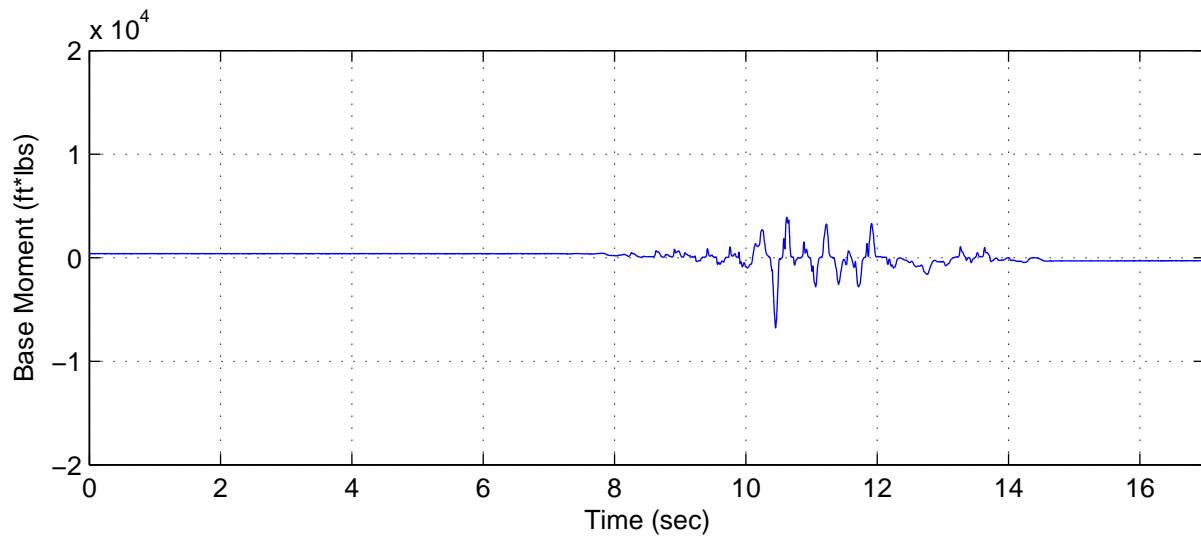
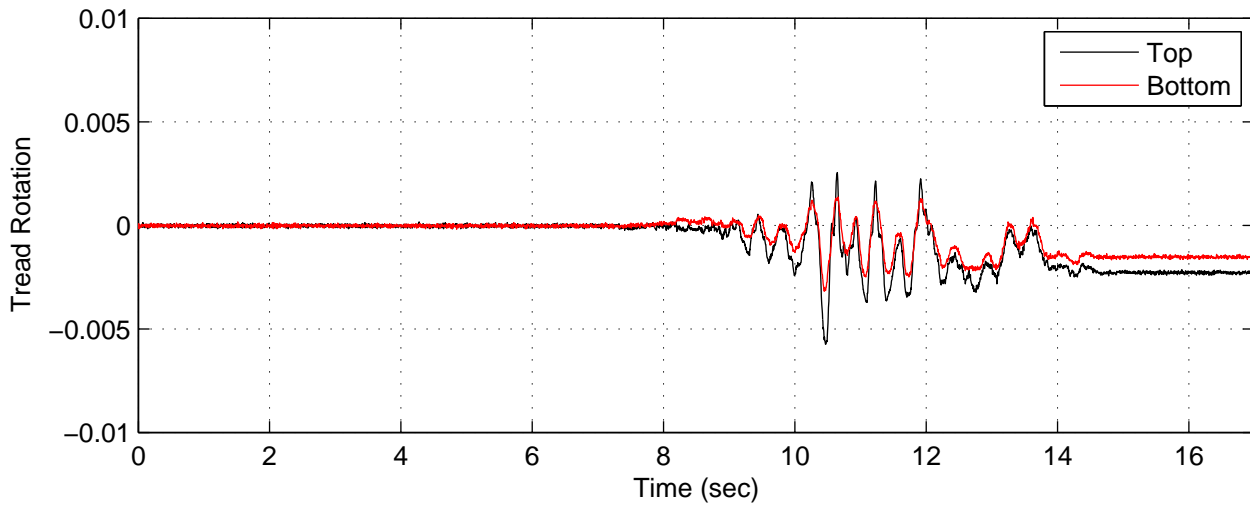
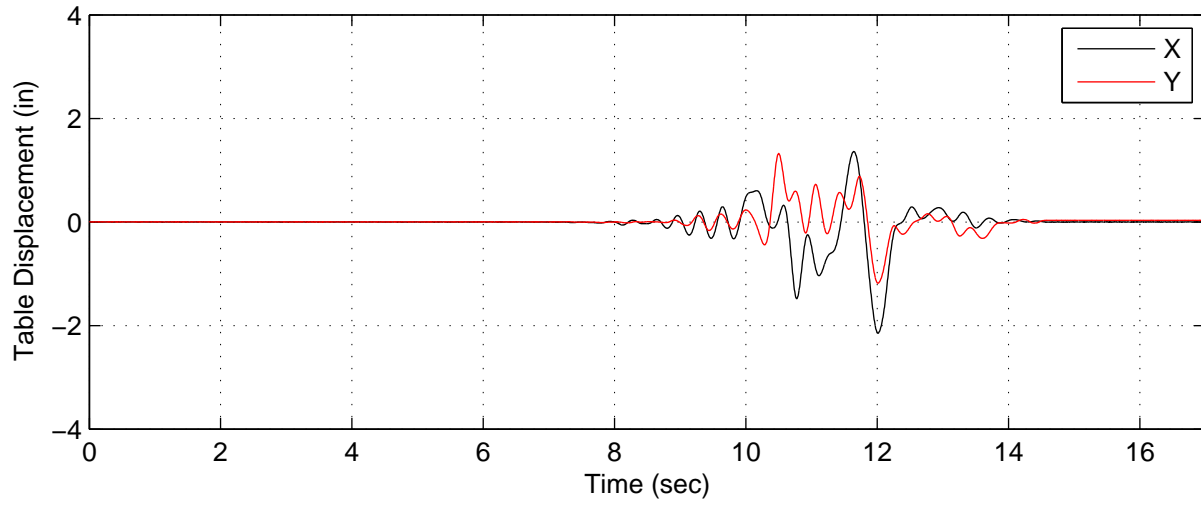



AP4 (No Added Mass) – Test Q, 3.75in. Newhall MCE – 0 deg Trans

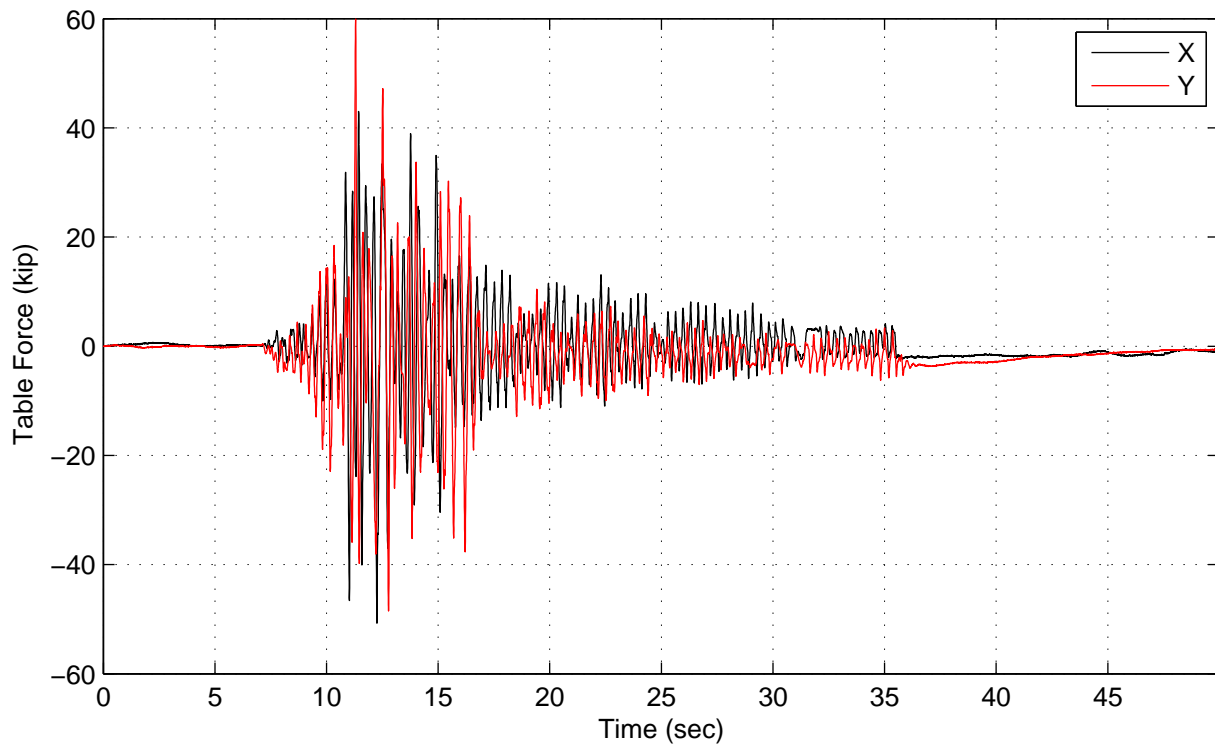
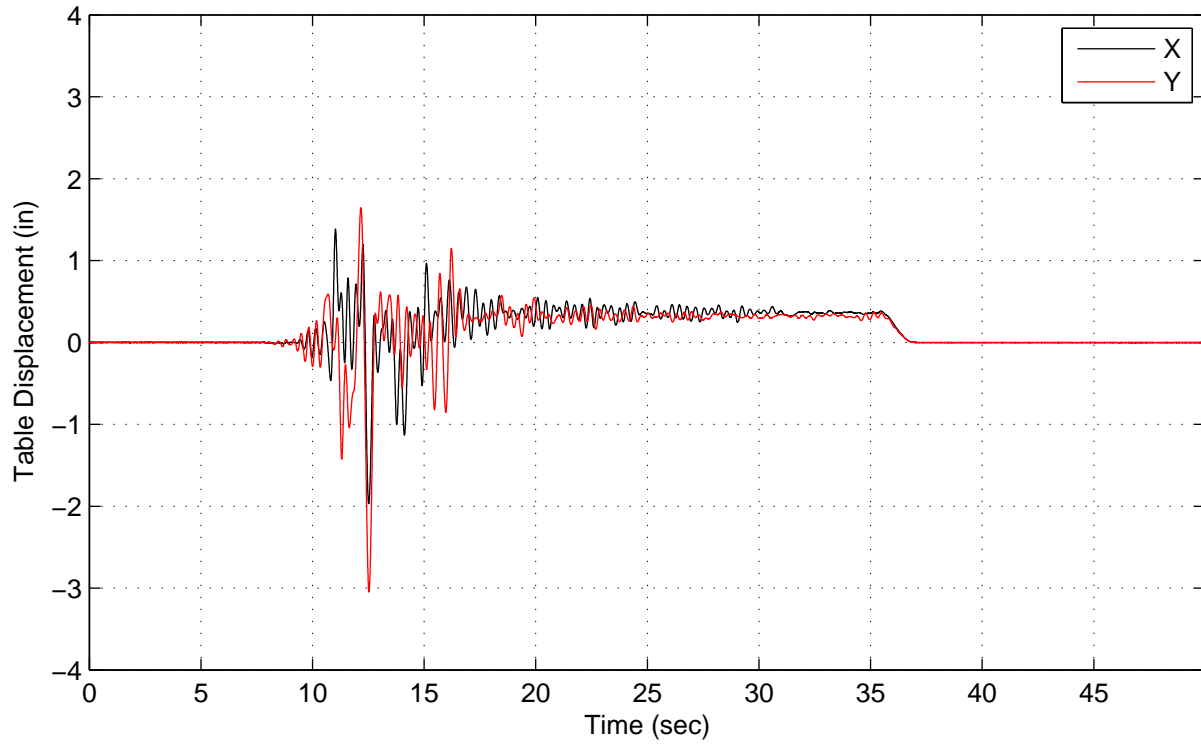

AP4 (No Added Mass) – Test Q, 3.75in. Newhall MCE – 0 deg Trans

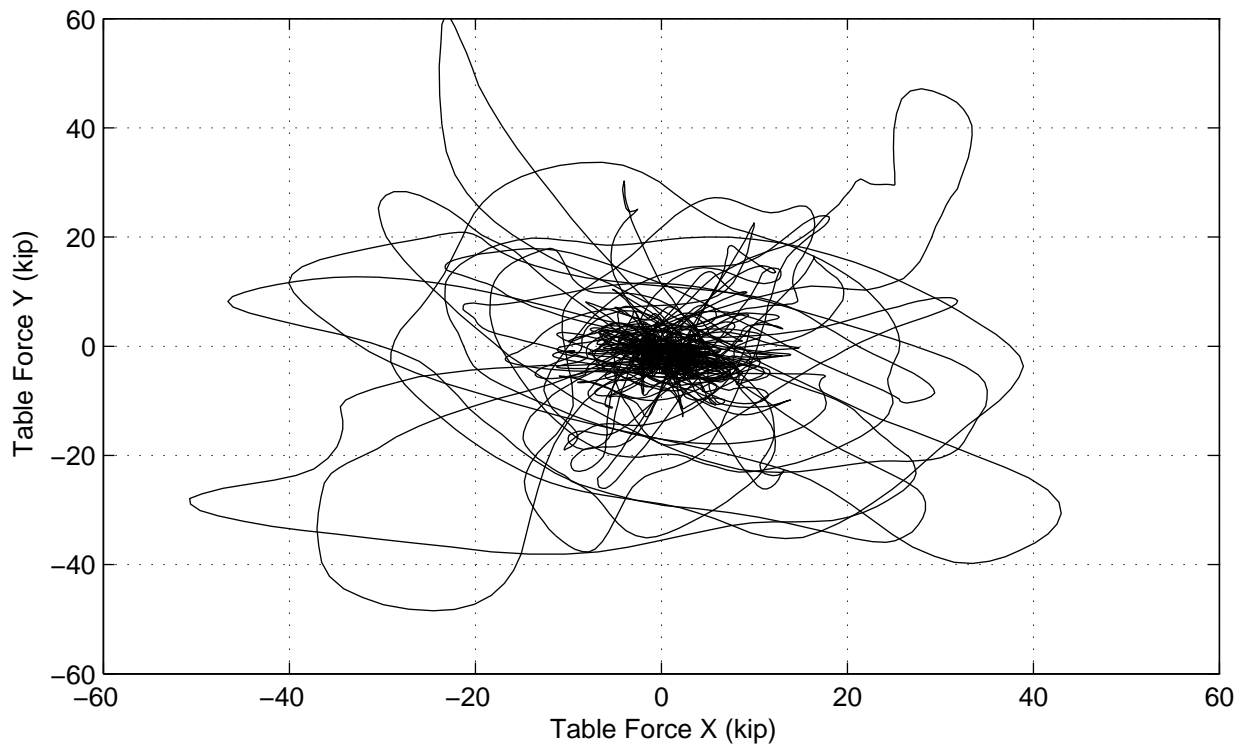
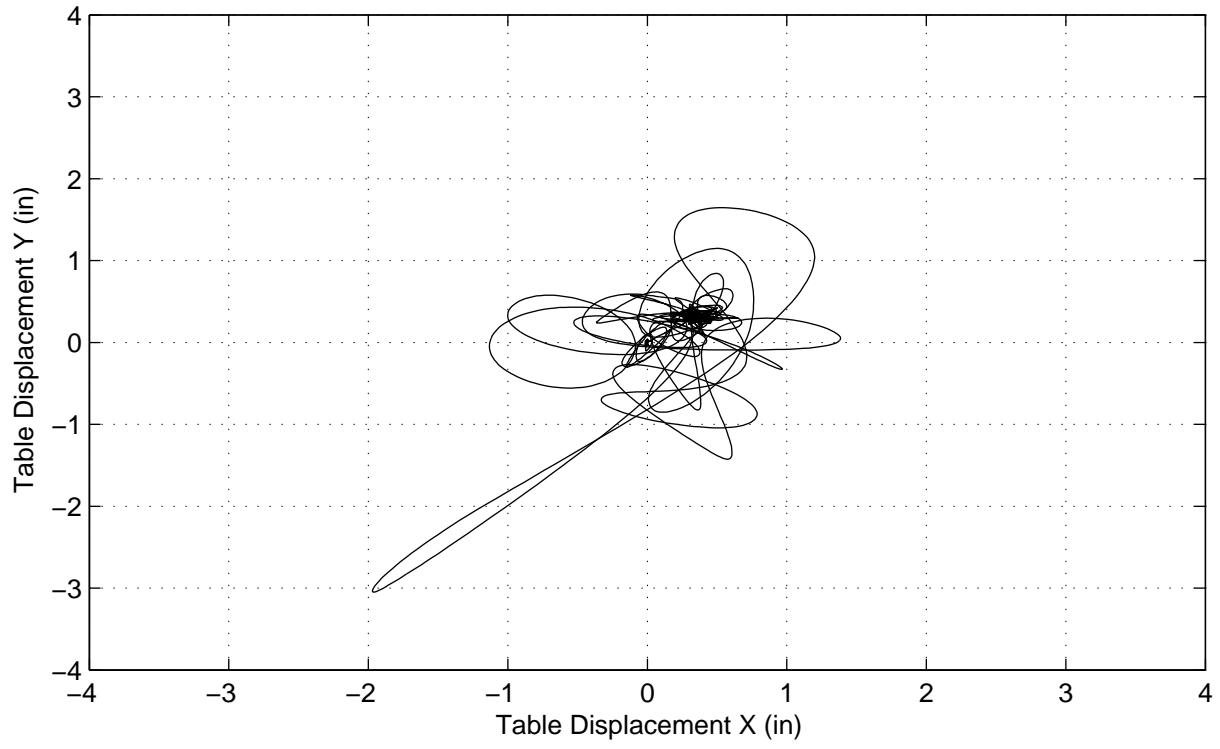

AP4 (No Added Mass) – Test Q, 3.75in. Newhall MCE – 0 deg Trans

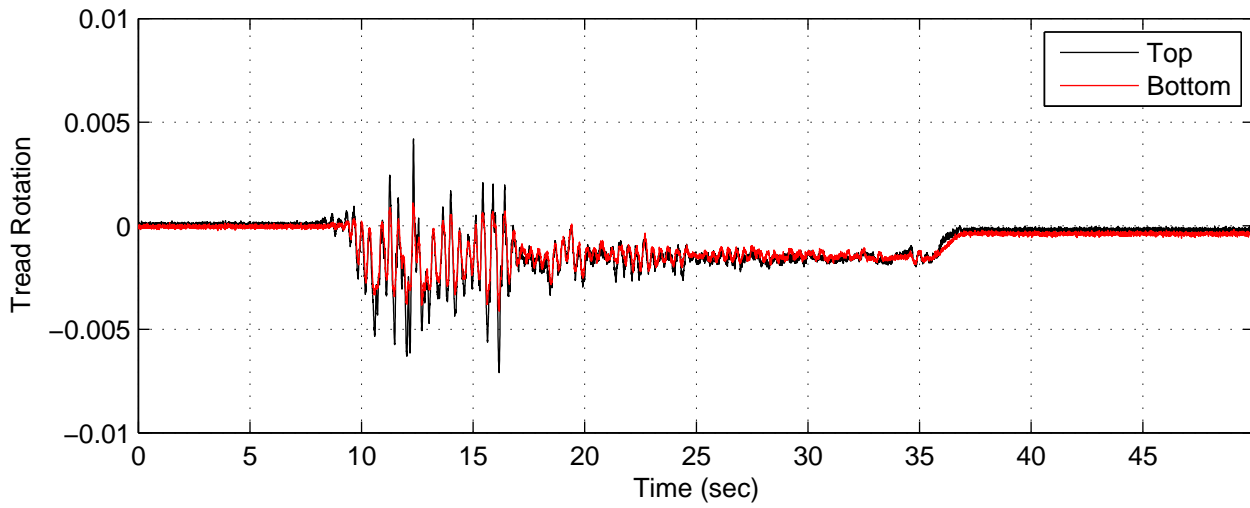
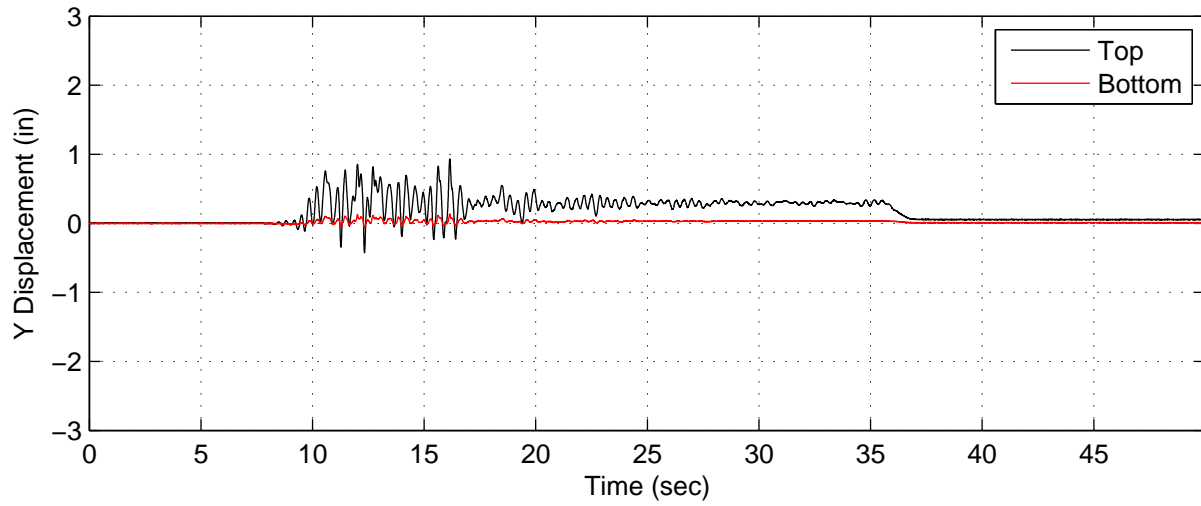
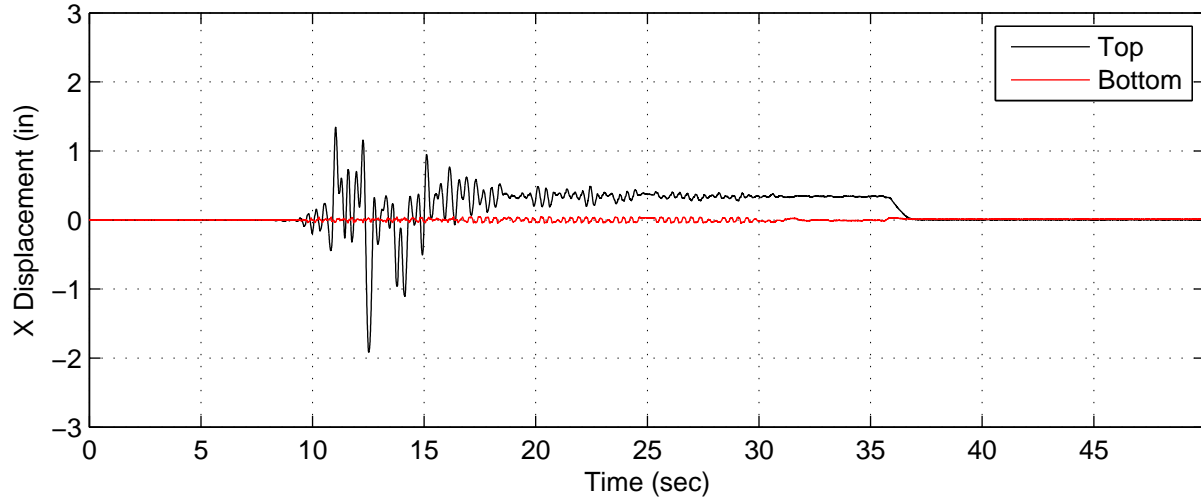

AP4 (No Added Mass) – Test Q, 3.75in. Newhall MCE – 0 deg Trans

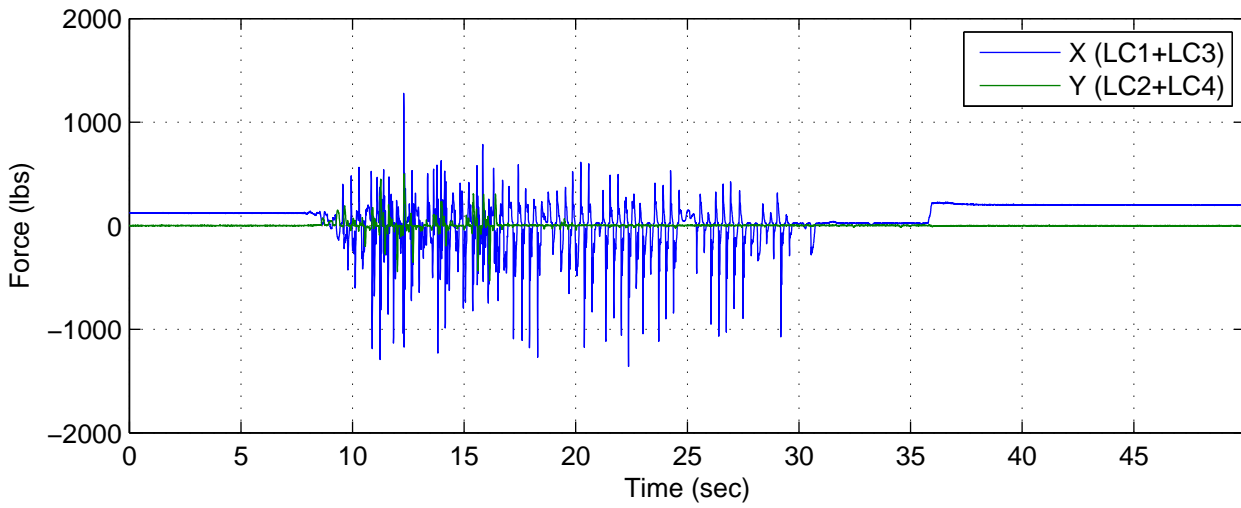
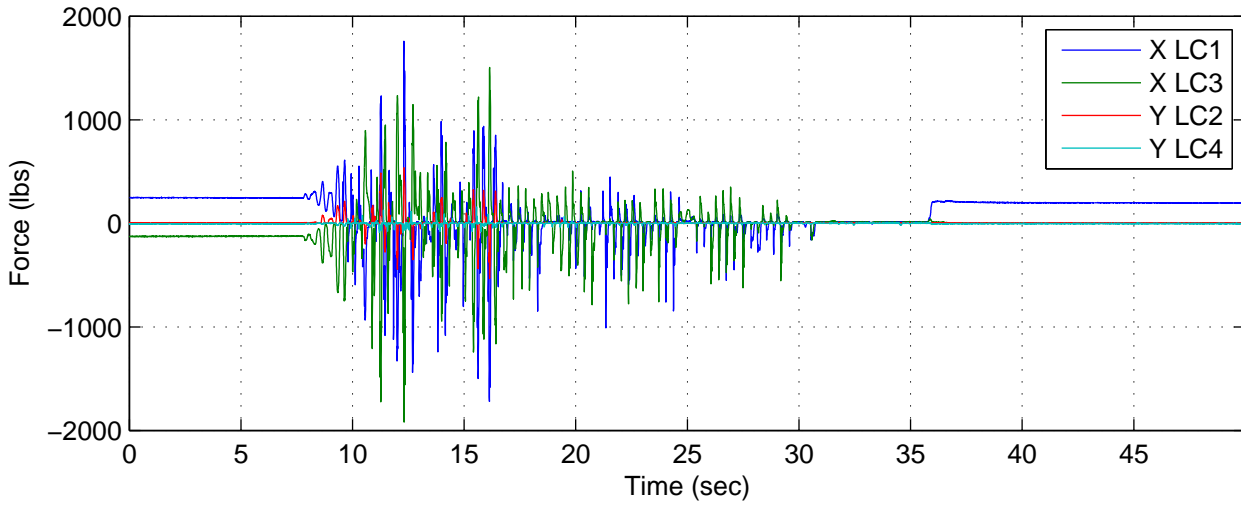
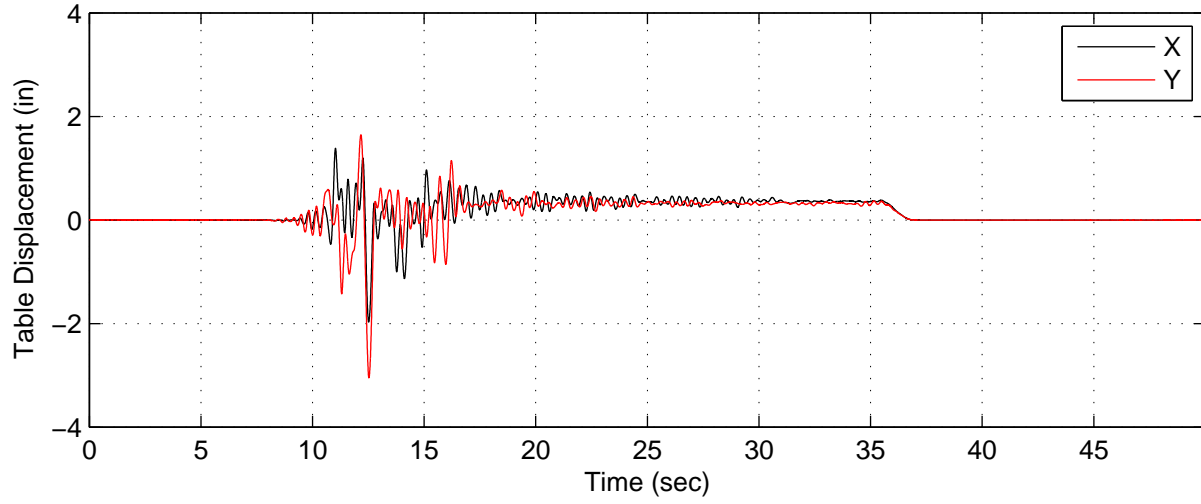

AP4 (No Added Mass) – Test Q, 3.75in. Newhall MCE – 0 deg Trans

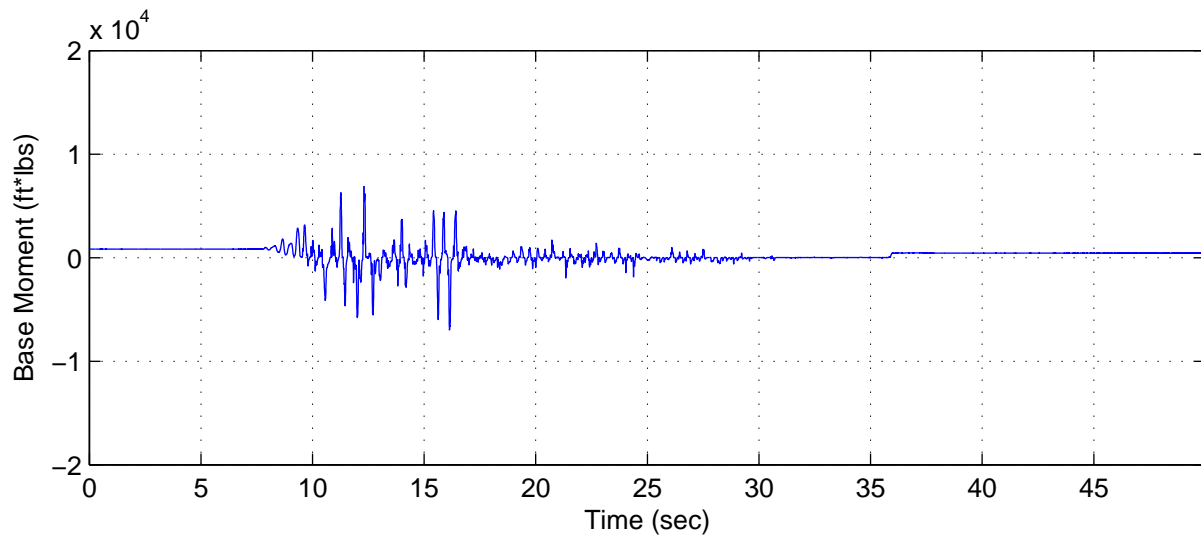
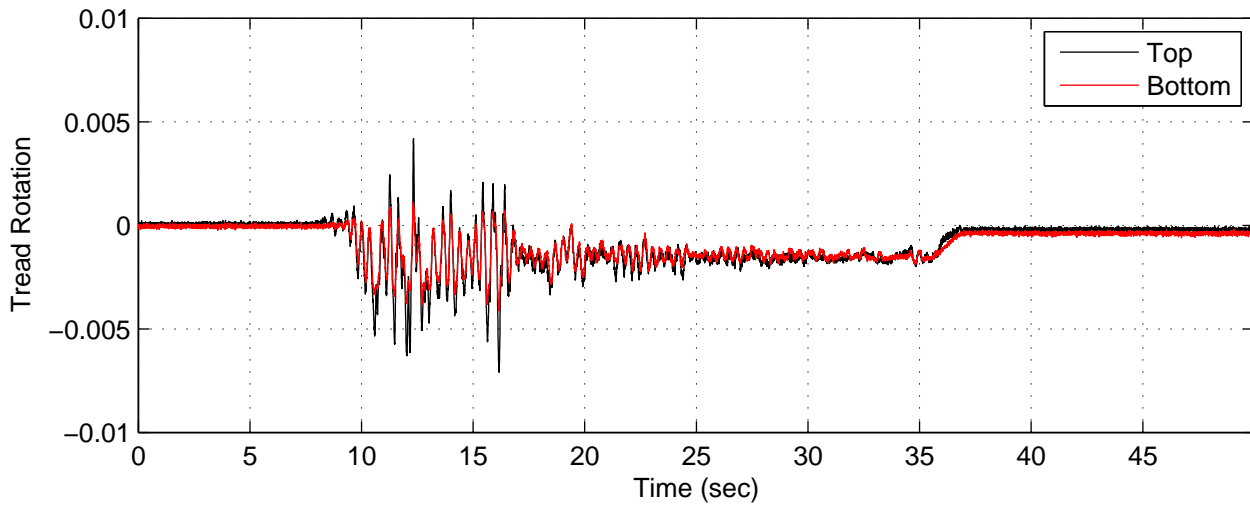
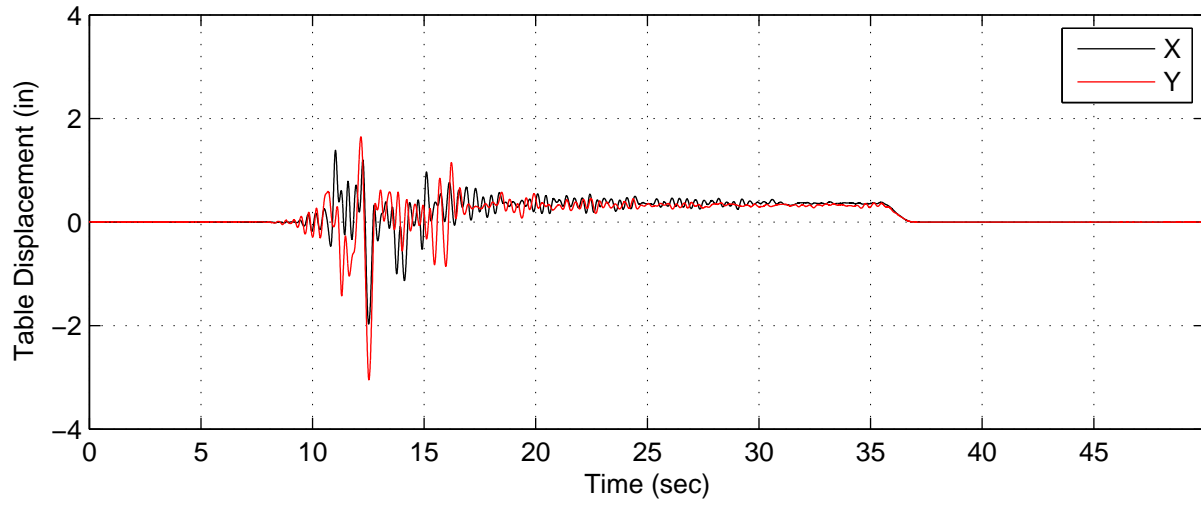

AP4 (Added Mass) – Test A, 0.5in. Quasi-static X Disp (4 Load Cells)

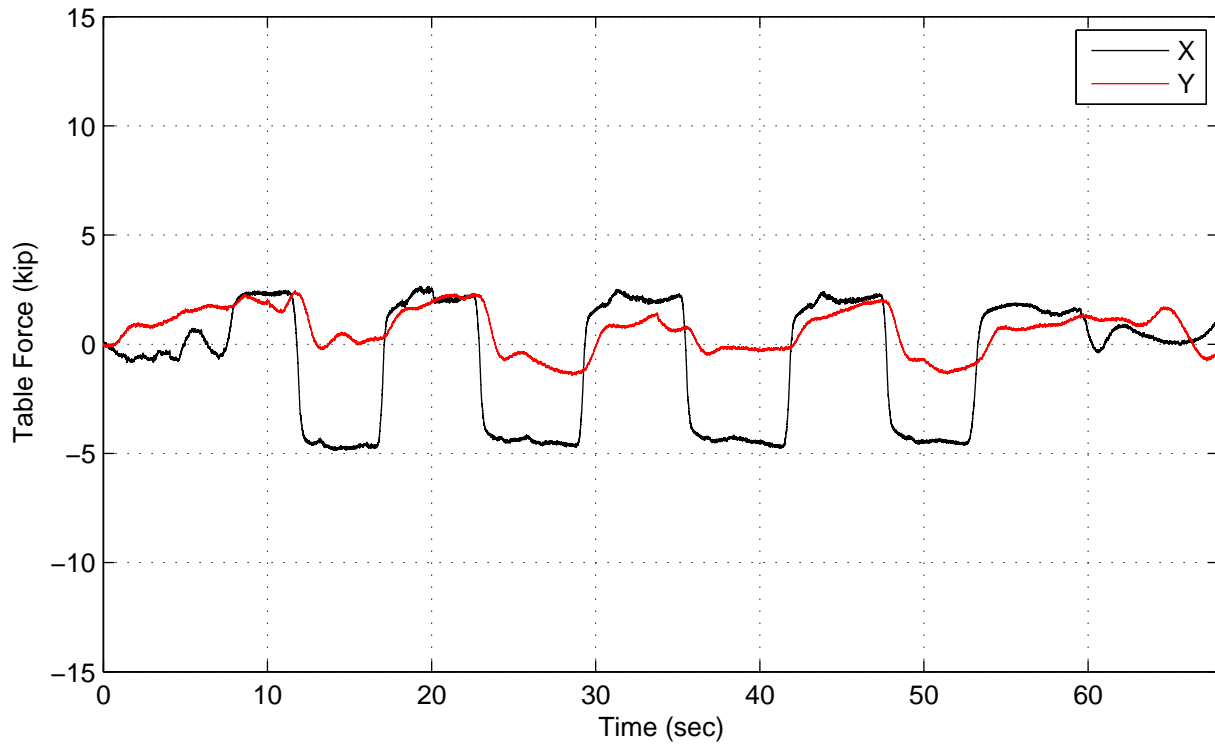
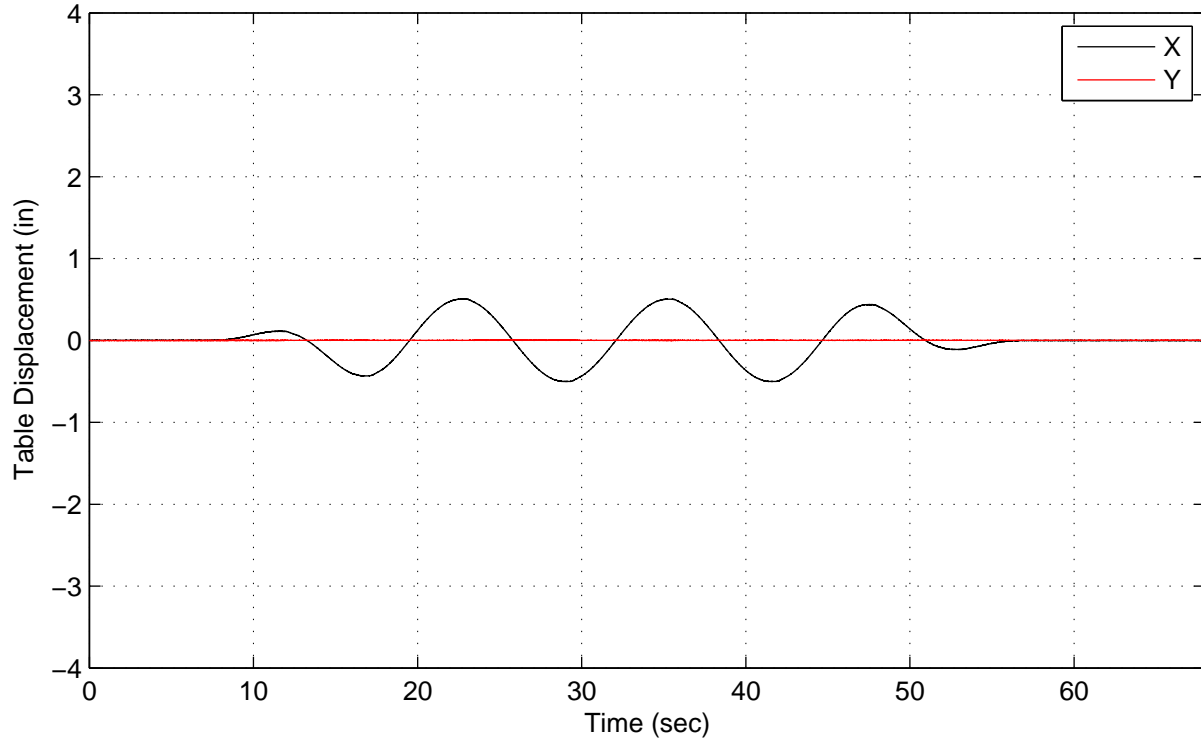

AP4 (Added Mass) – Test A, 0.5in. Quasi-static X Disp (4 Load Cells)

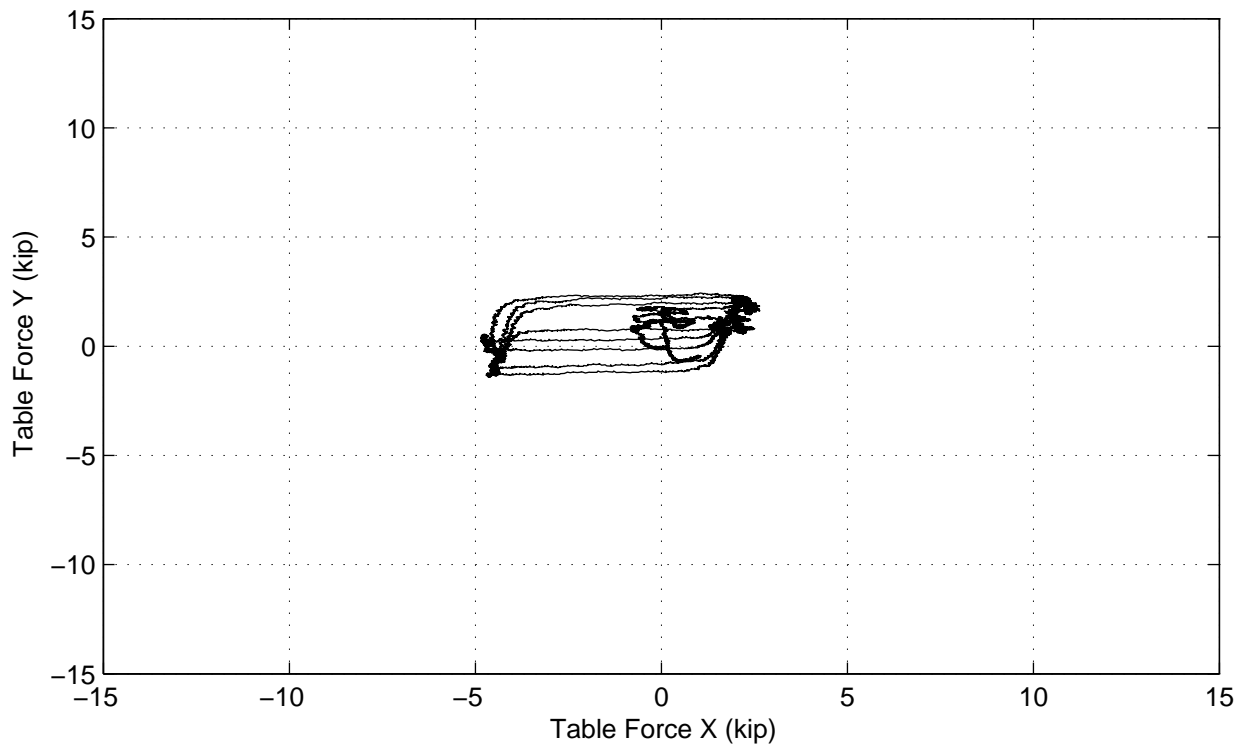
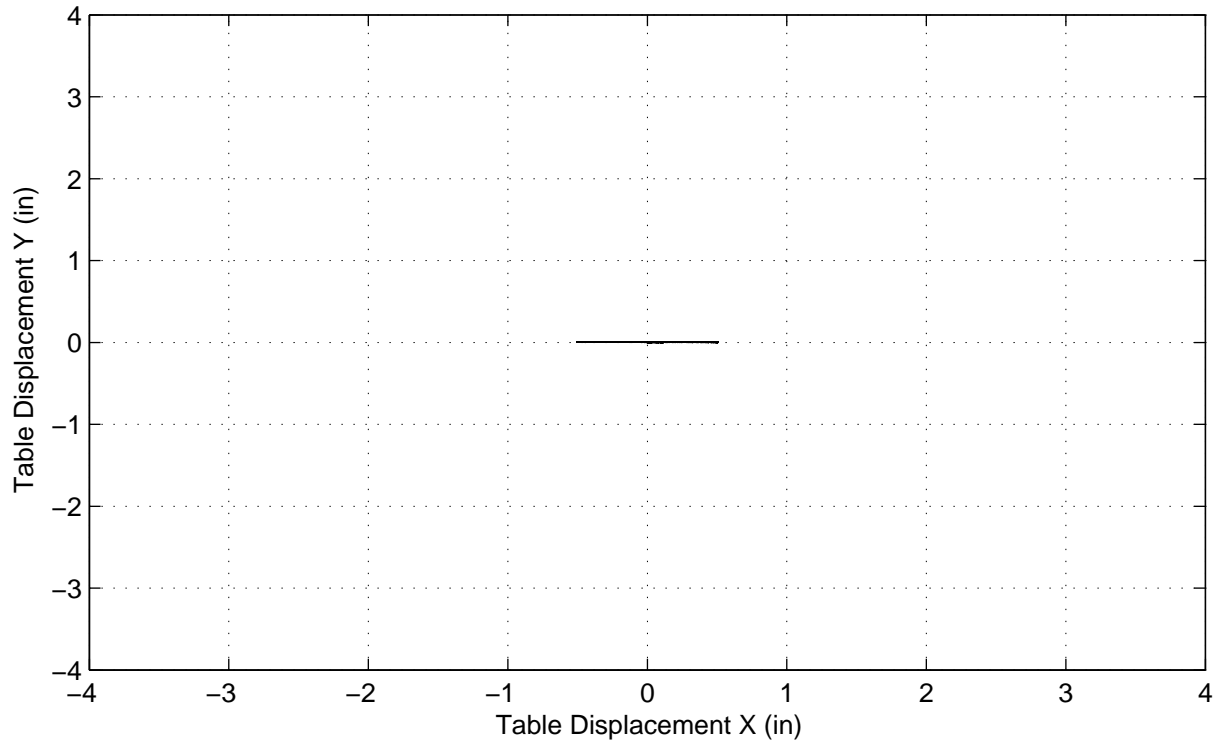

AP4 (Added Mass) – Test A, 0.5in. Quasi-static X Disp (4 Load Cells)

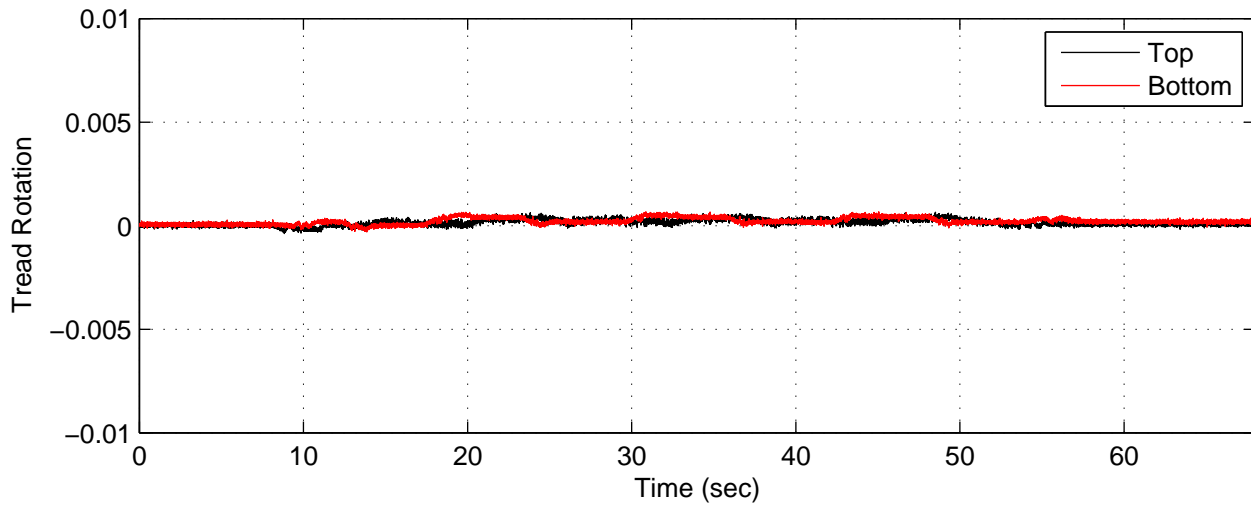
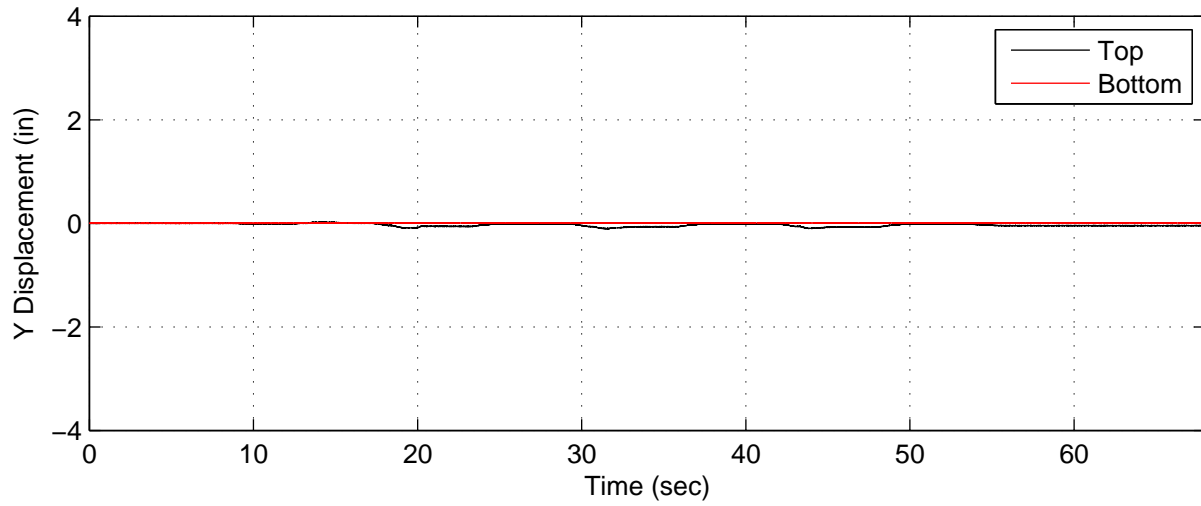
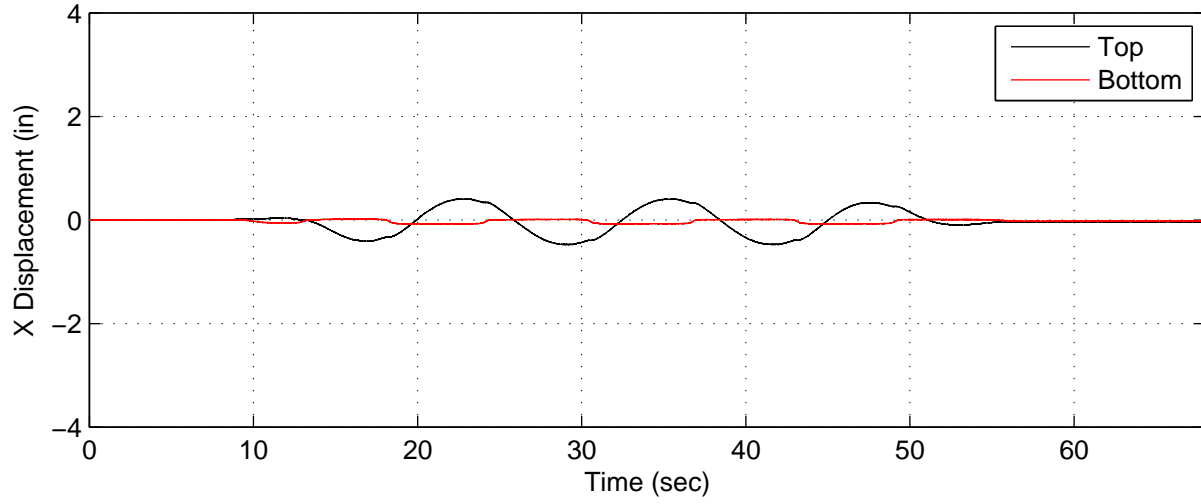



AP4 (Added Mass) – Test A, 0.5in. Quasi-static X Disp (4 Load Cells)

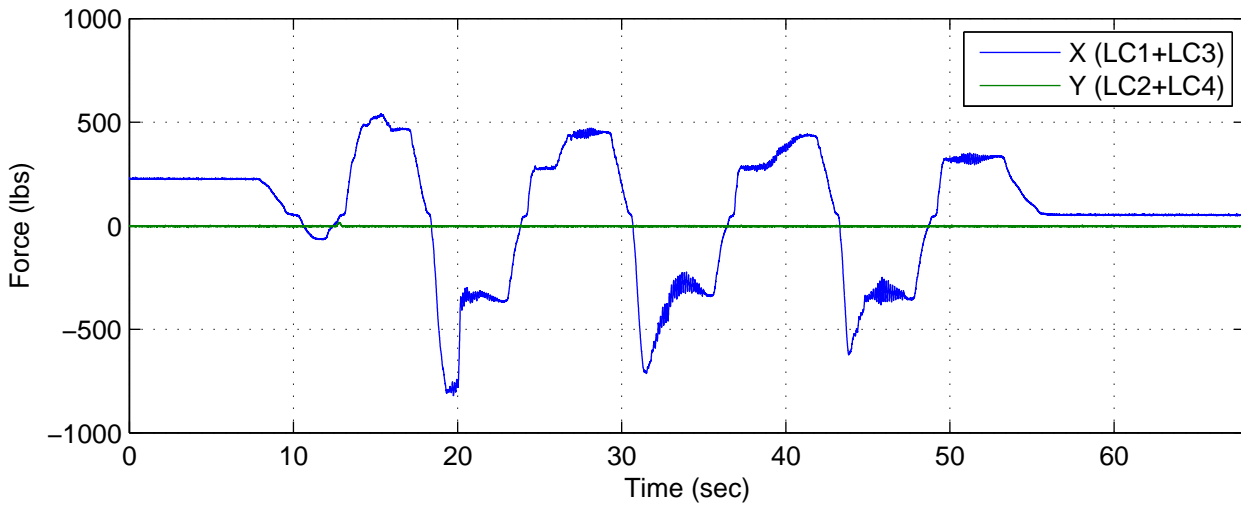
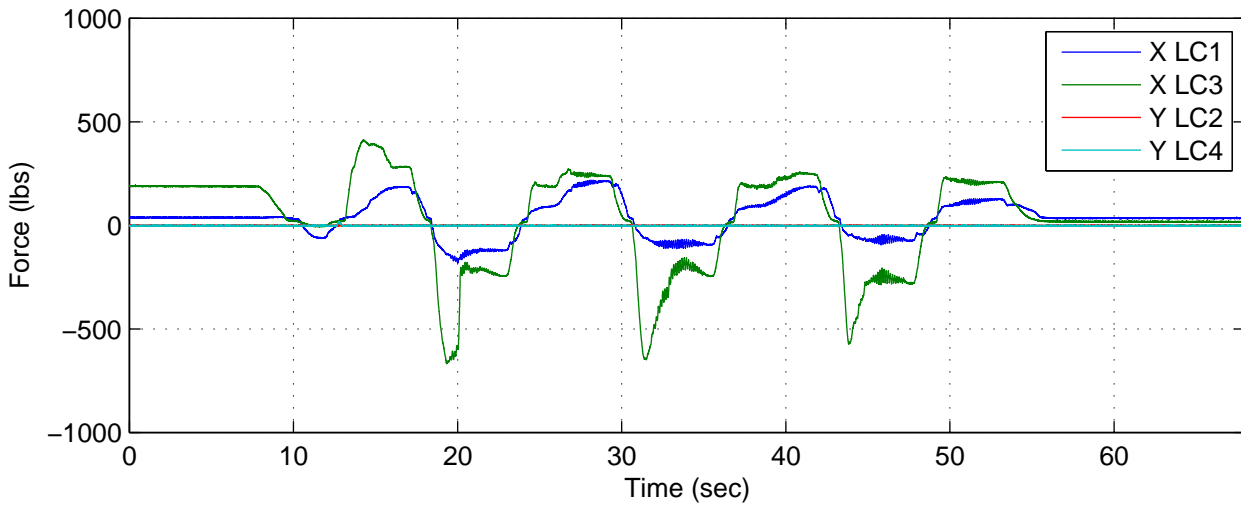
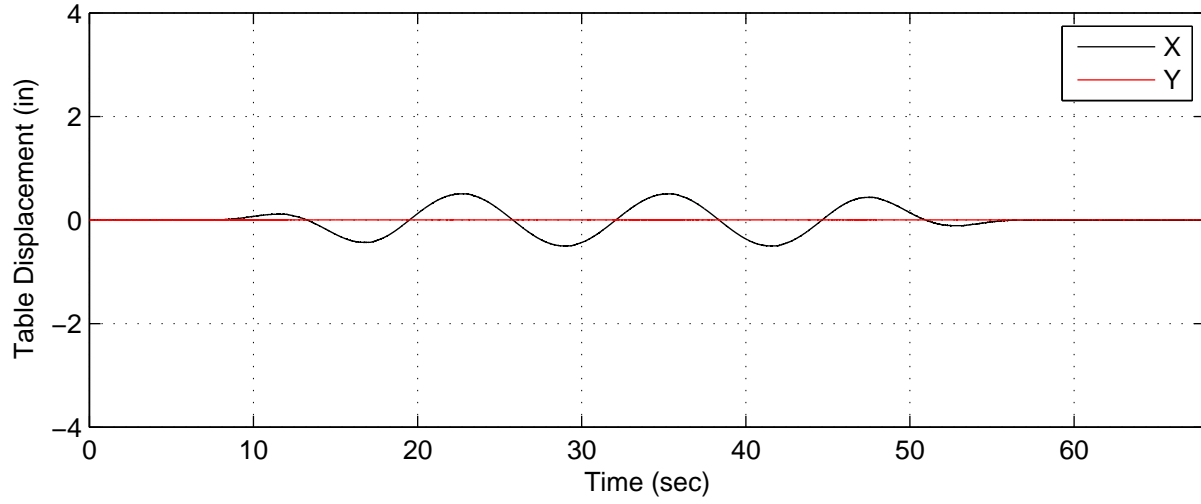

AP4 (Added Mass) – Test A, 0.5in. Quasi-static X Disp (4 Load Cells)

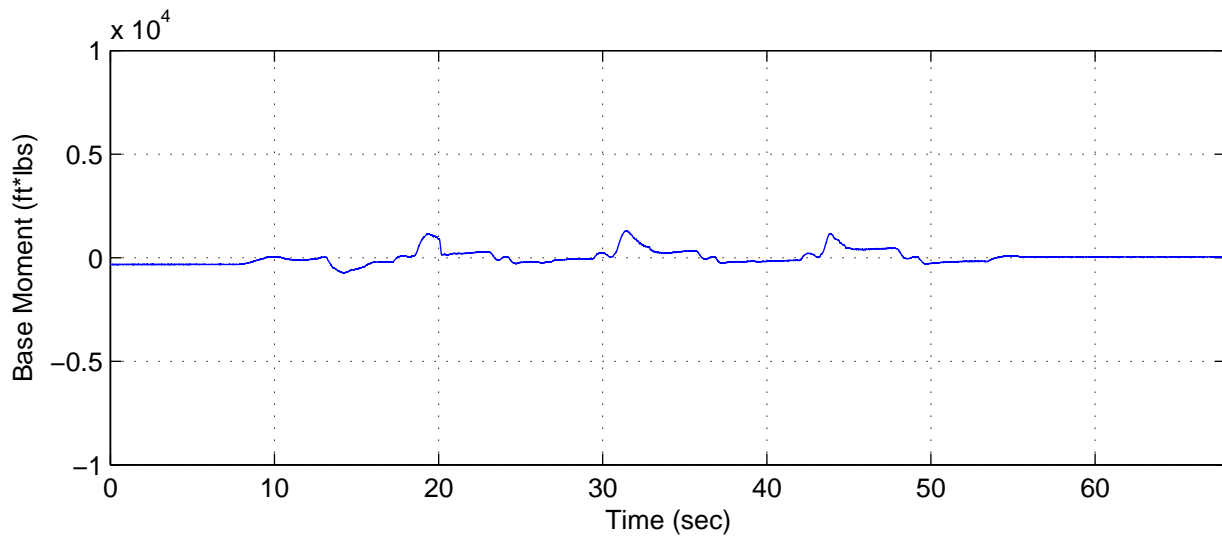
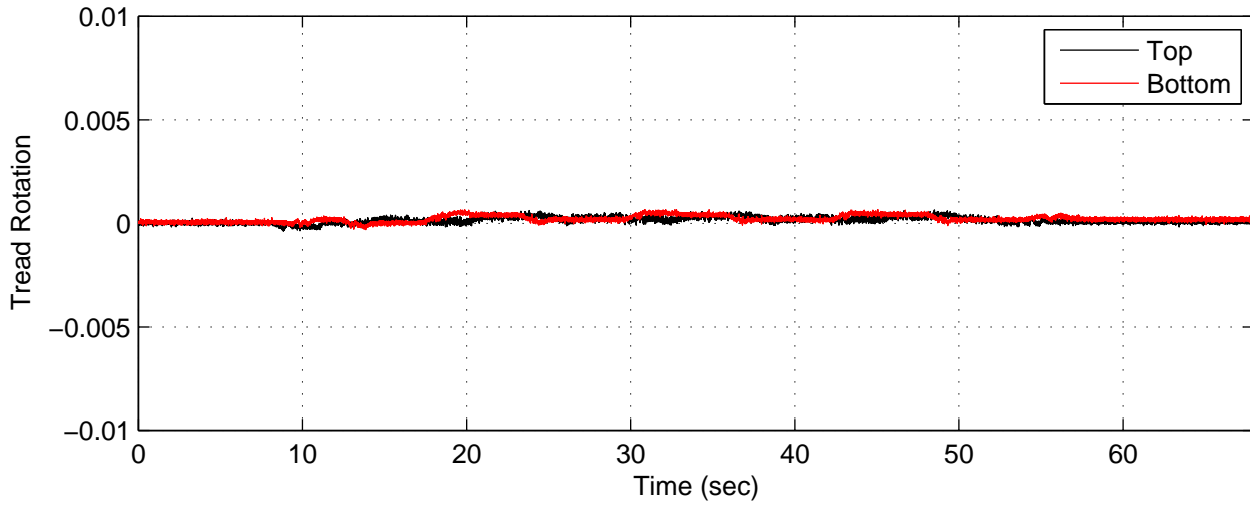
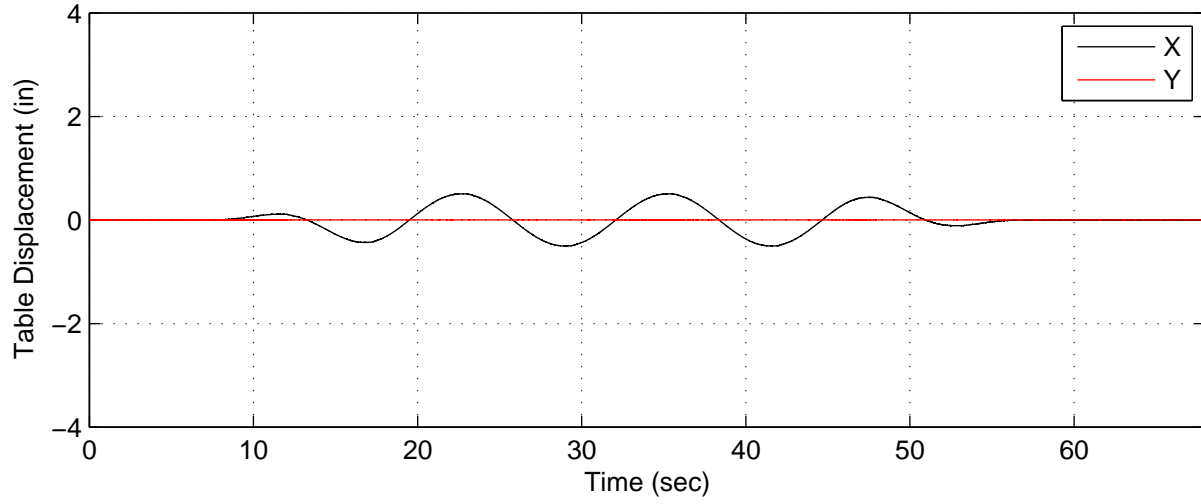

AP4 (Added Mass) – Test B, 2.5in. Quasi-static X Disp (4 Load Cells)

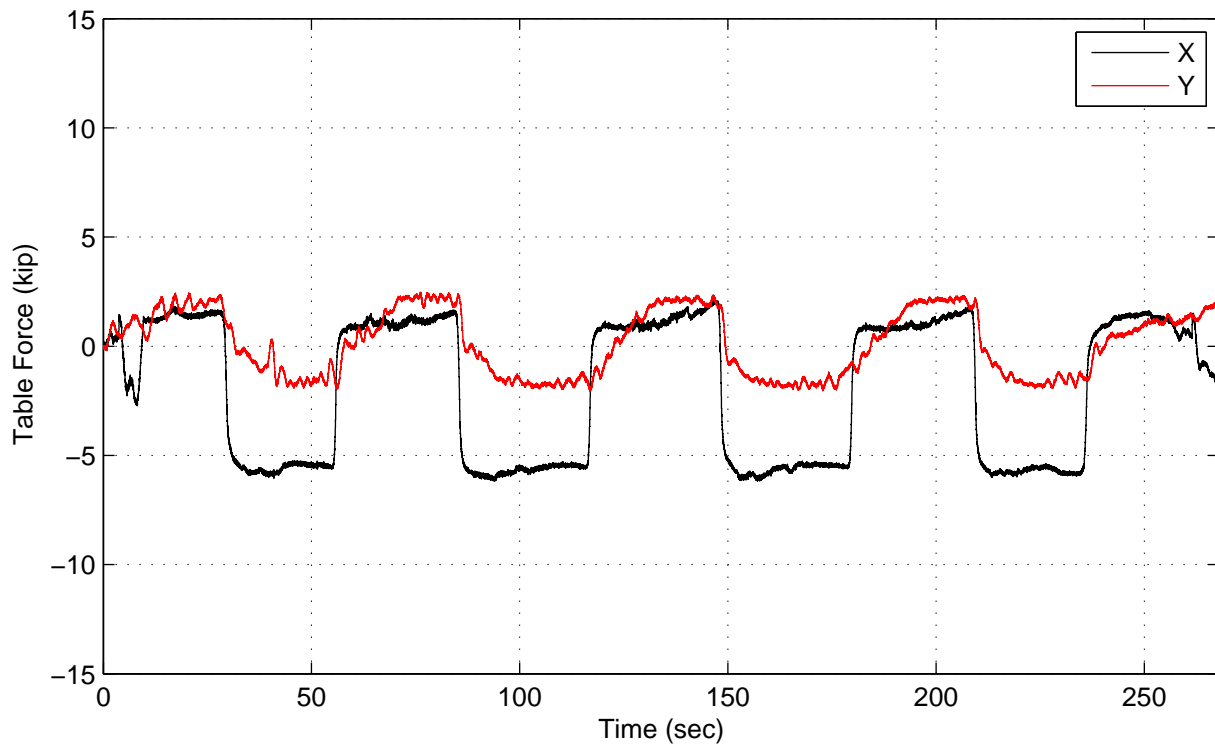
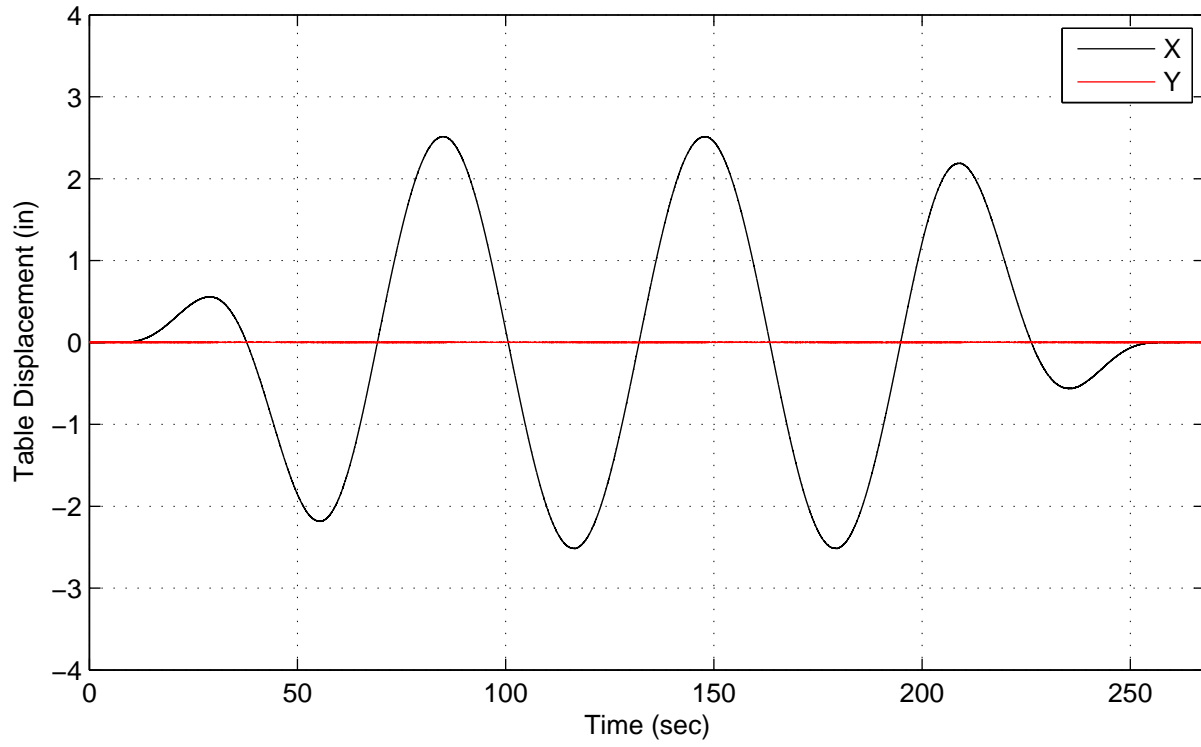

AP4 (Added Mass) – Test B, 2.5in. Quasi-static X Disp (4 Load Cells)

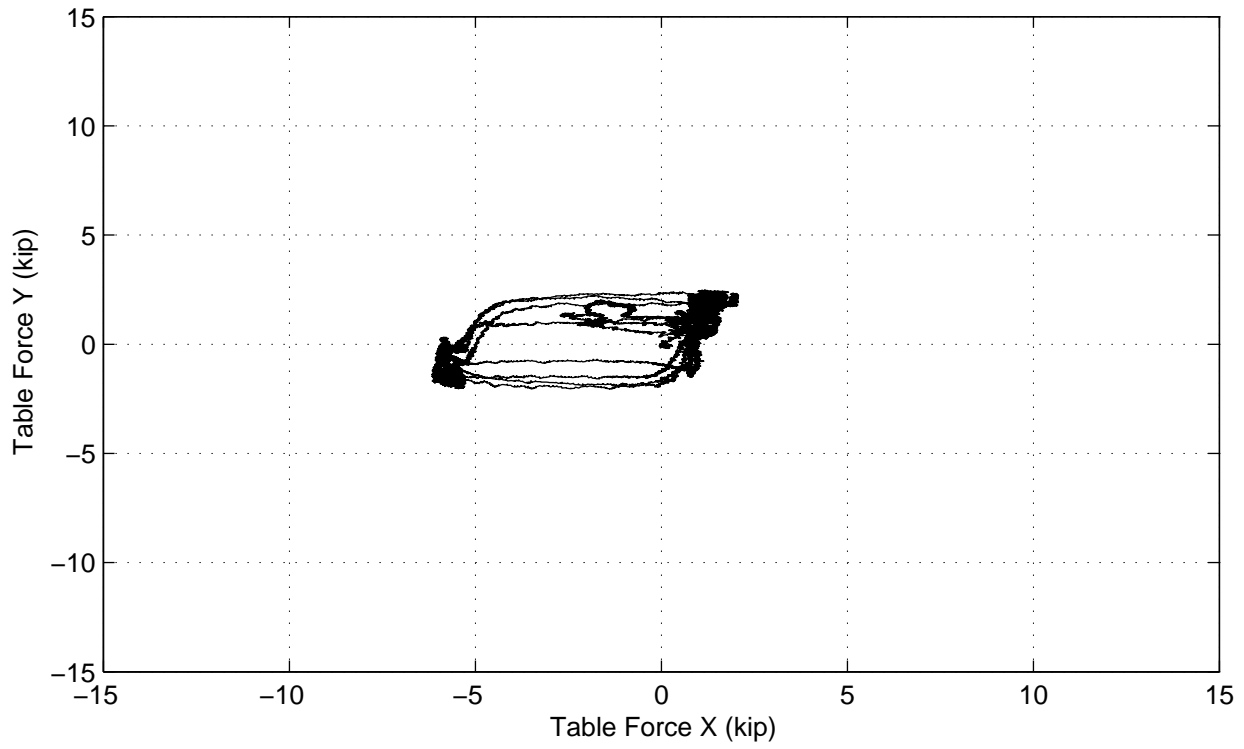
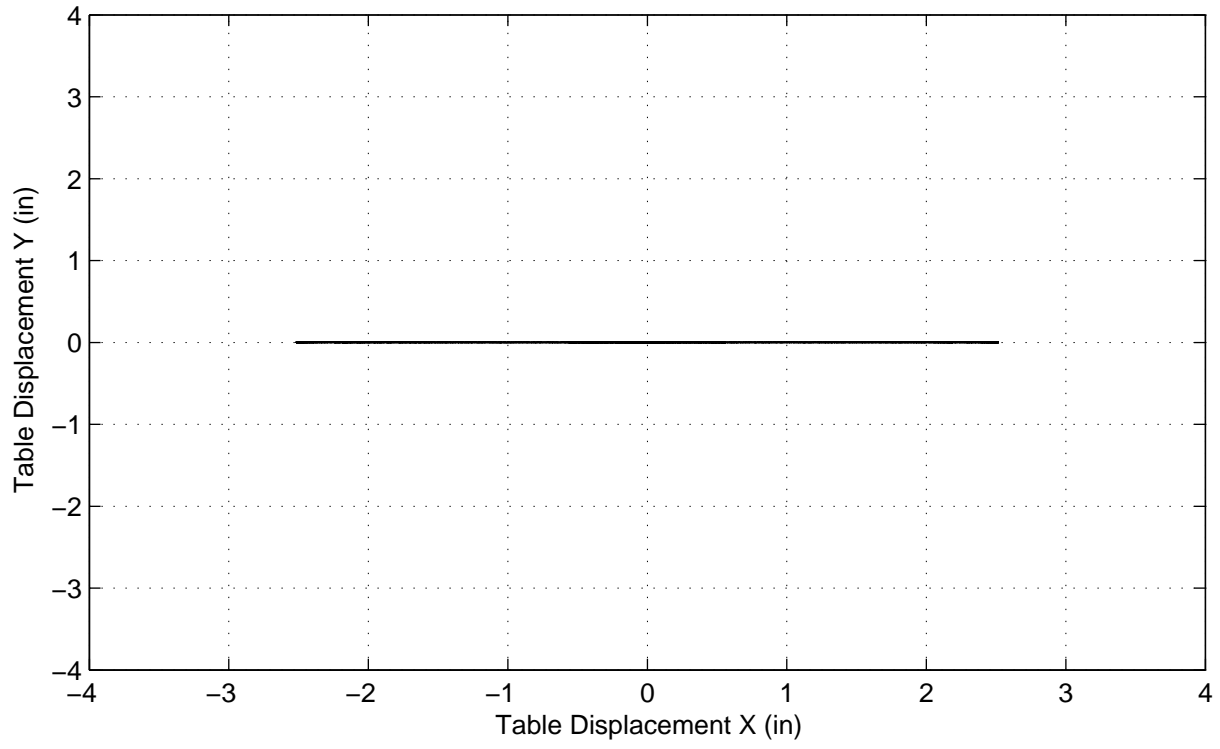

AP4 (Added Mass) – Test B, 2.5in. Quasi-static X Disp (4 Load Cells)

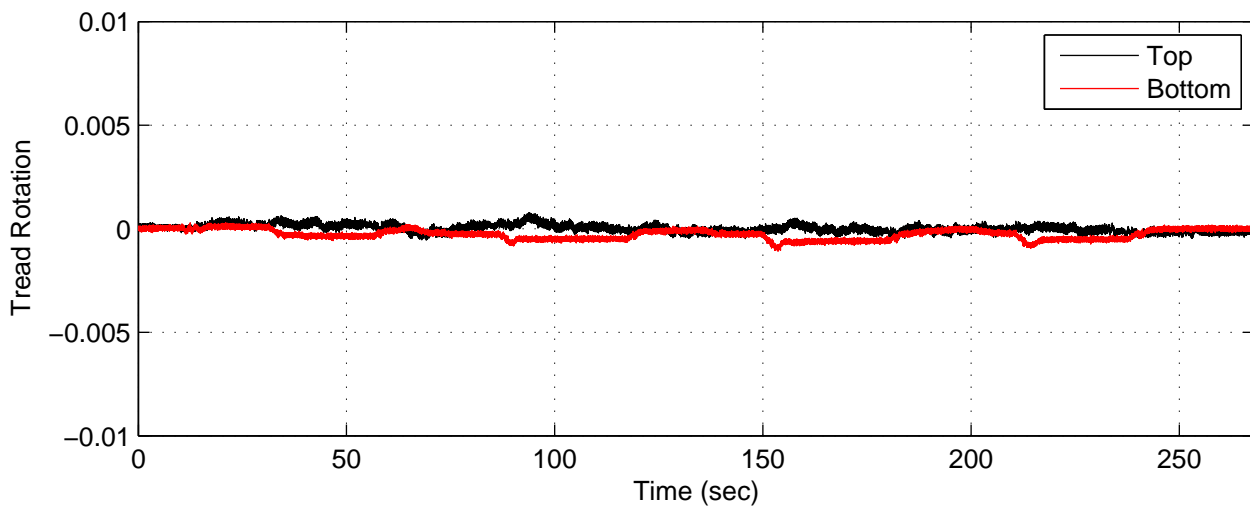
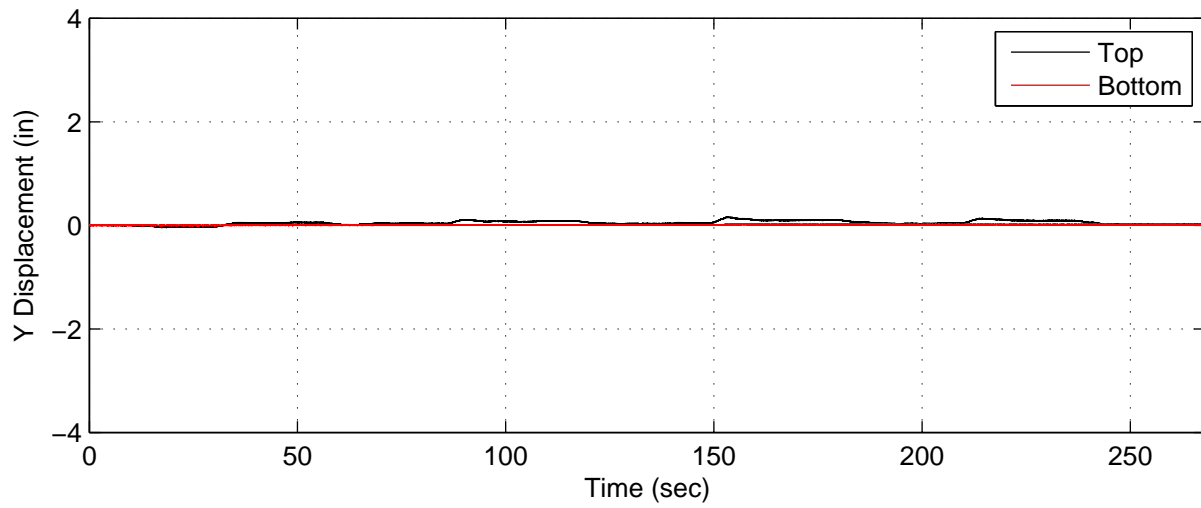
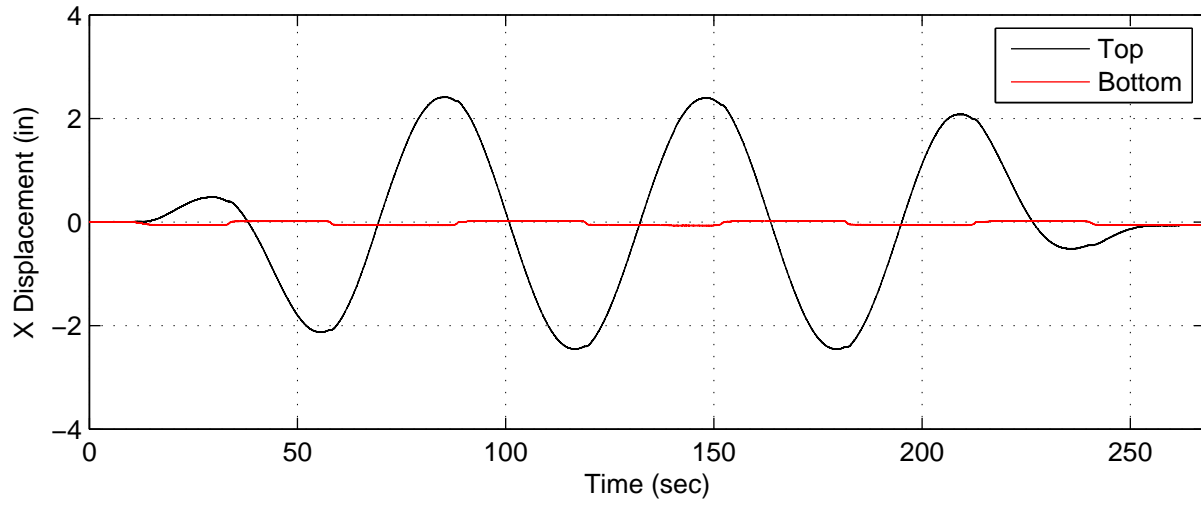

AP4 (Added Mass) – Test B, 2.5in. Quasi-static X Disp (4 Load Cells)

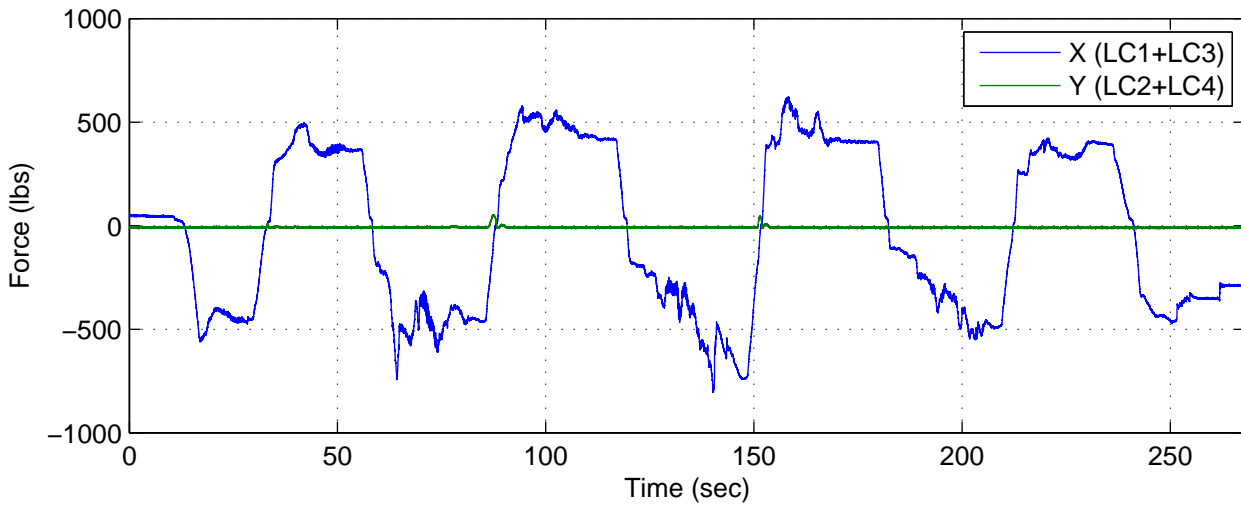
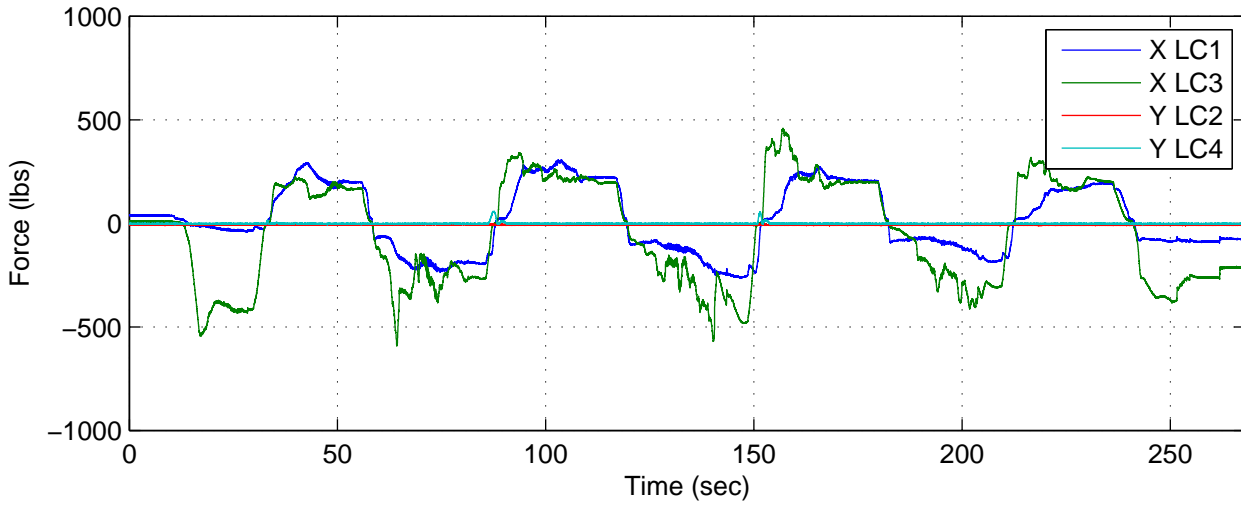
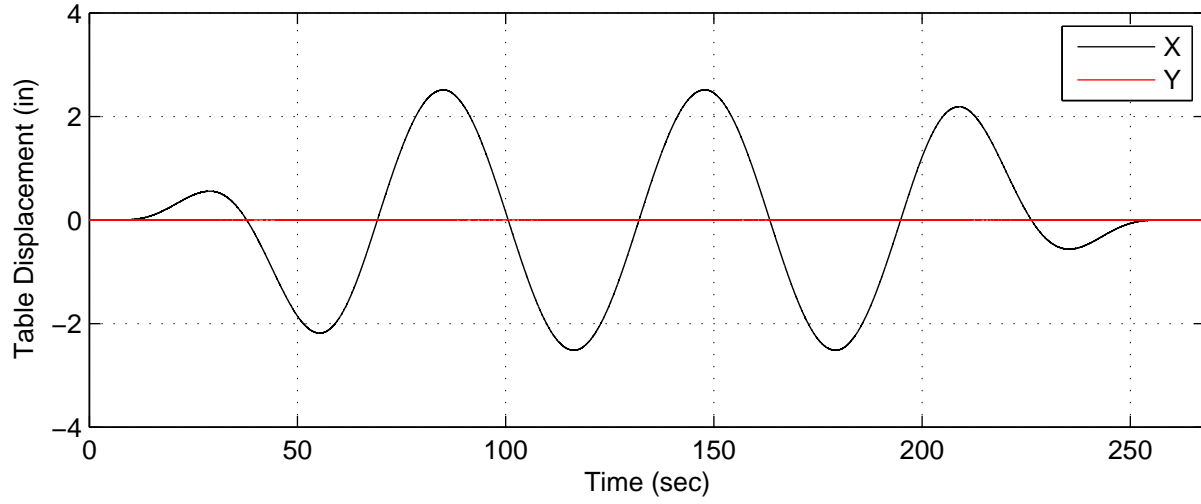

AP4 (Added Mass) – Test B, 2.5in. Quasi-static X Disp (4 Load Cells)

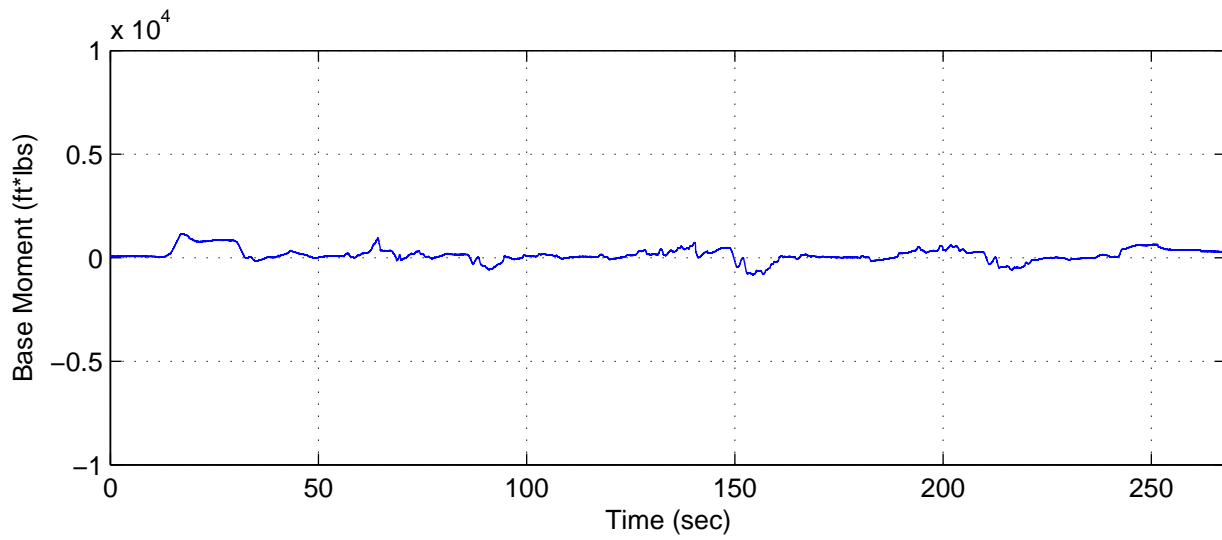
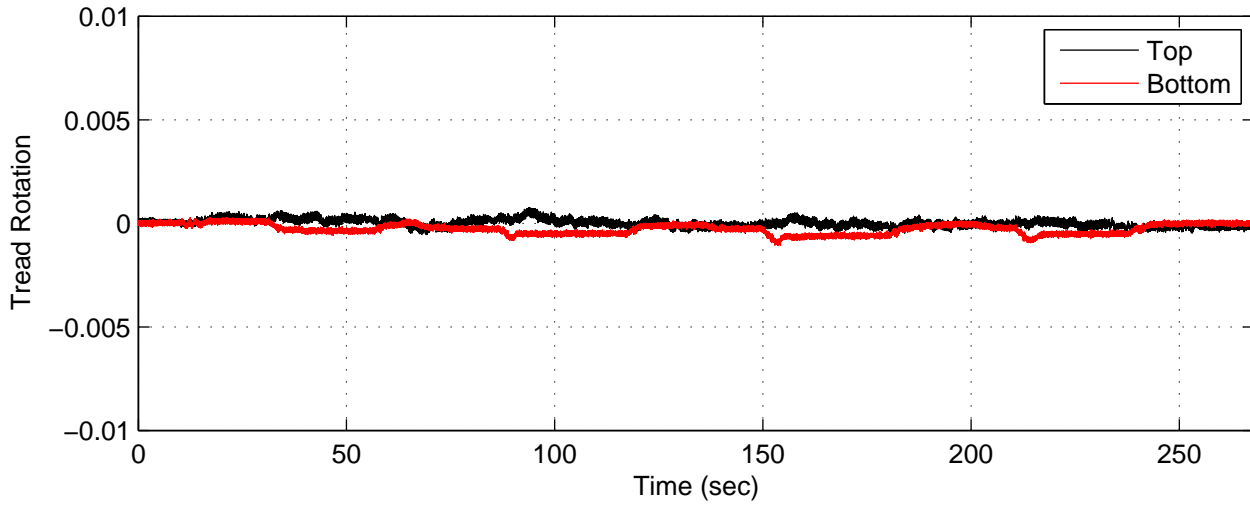
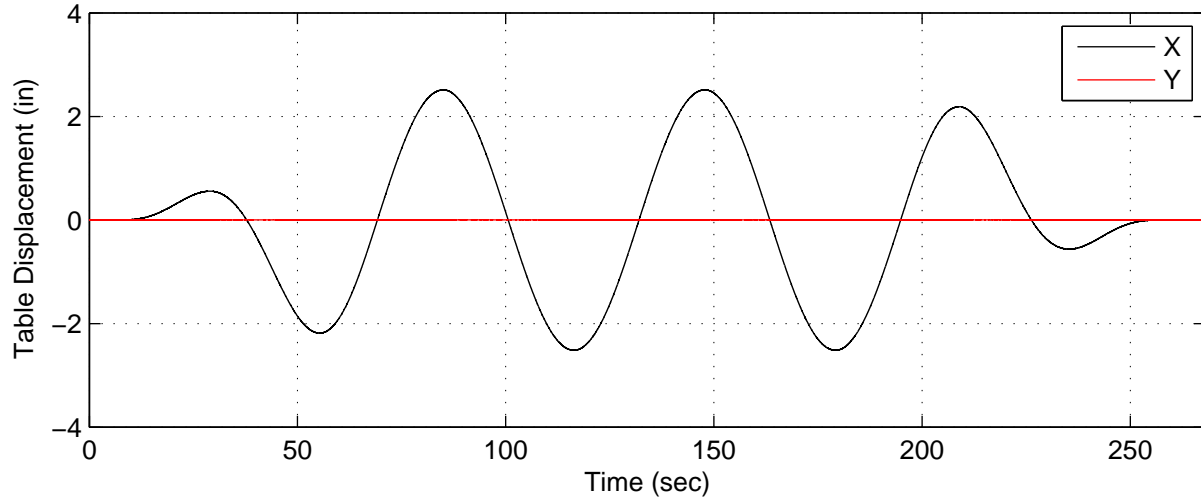

AP4 (Added Mass) – Test C, 0.5in. Quasi-static Y Disp (4 Load Cells)

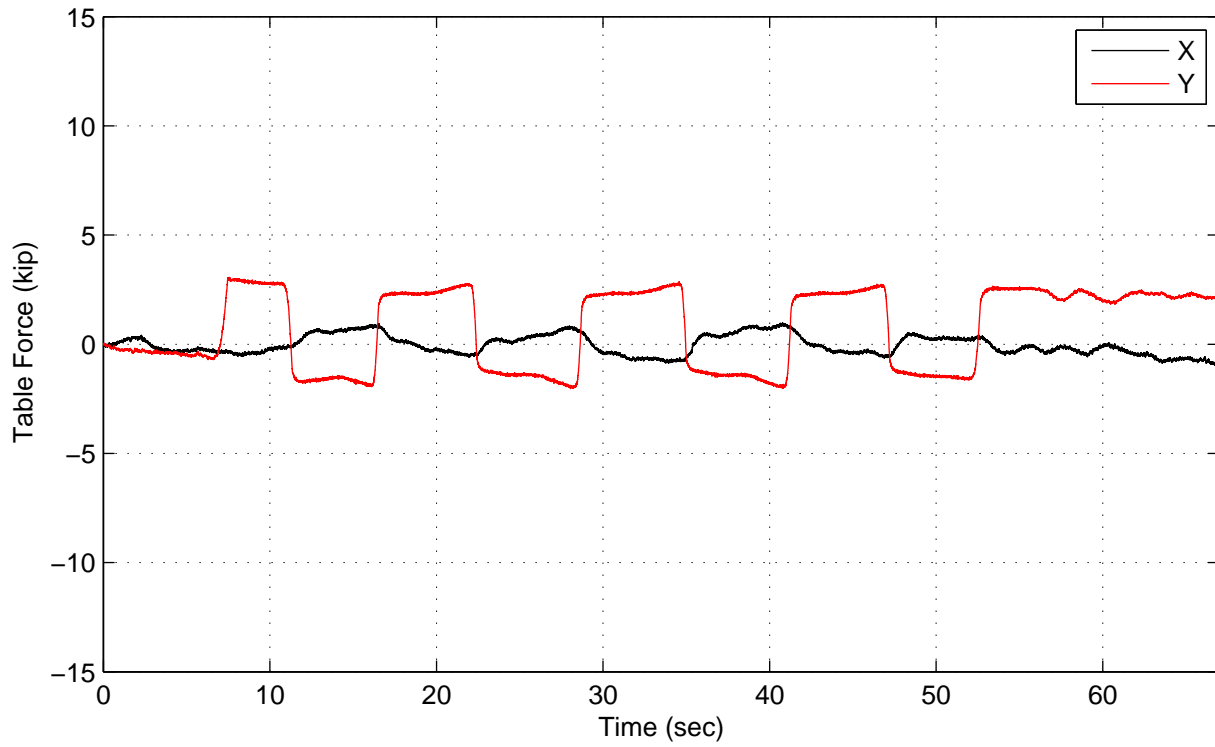
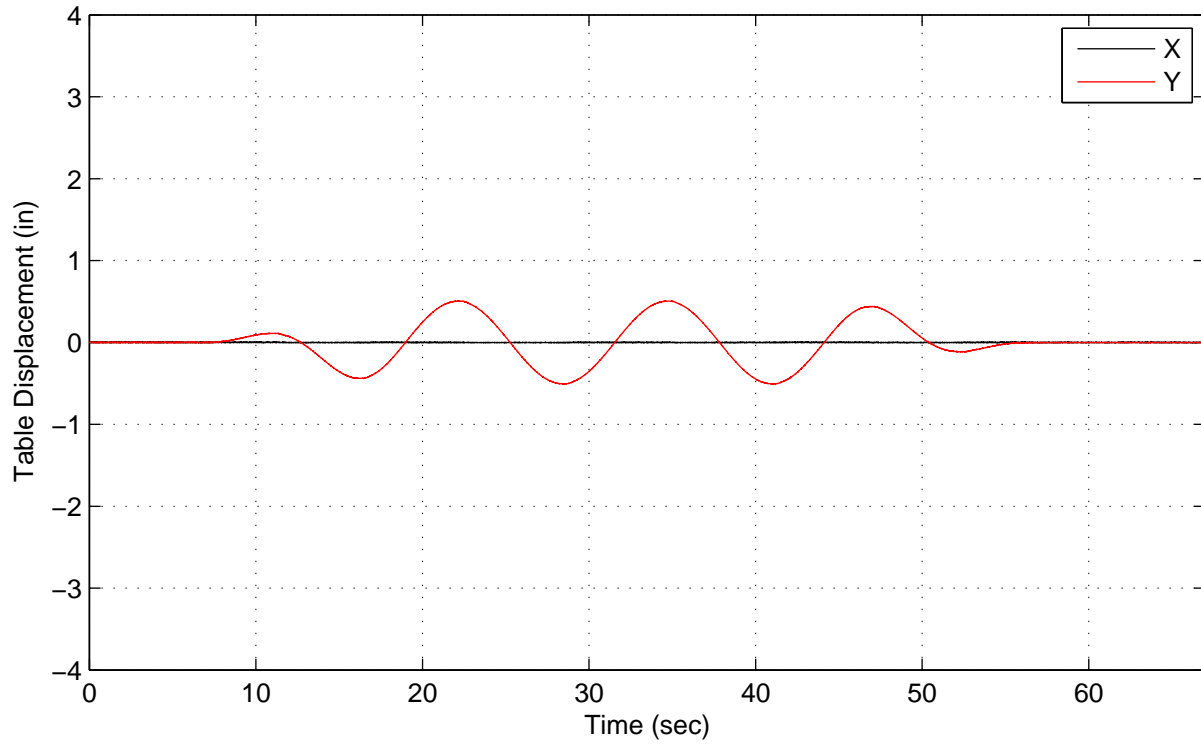



AP4 (Added Mass) – Test C, 0.5in. Quasi-static Y Disp (4 Load Cells)

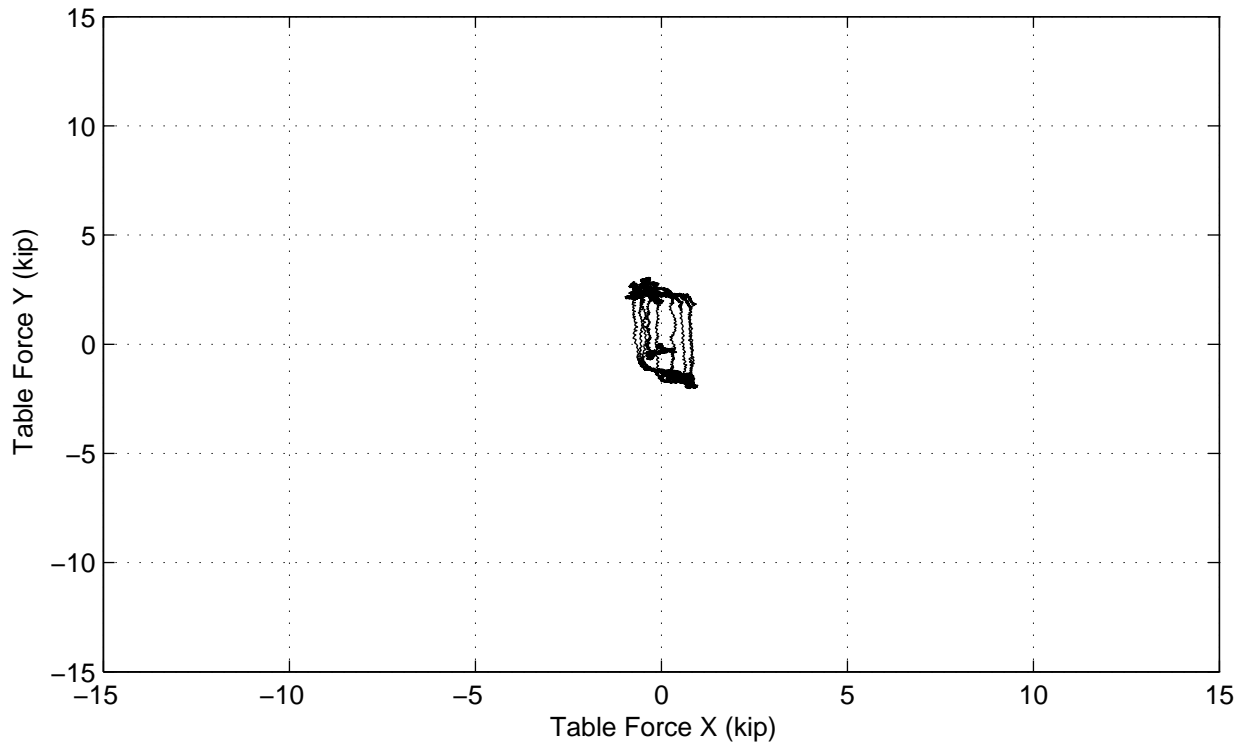
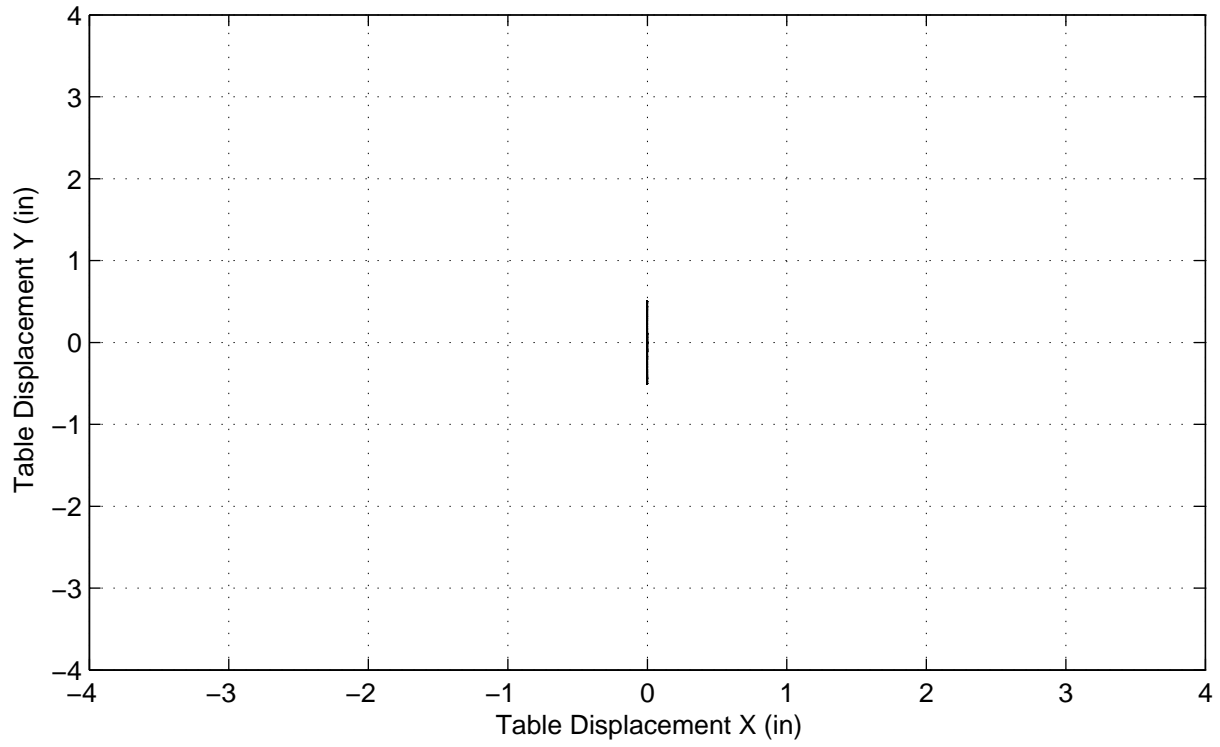

AP4 (Added Mass) – Test C, 0.5in. Quasi-static Y Disp (4 Load Cells)

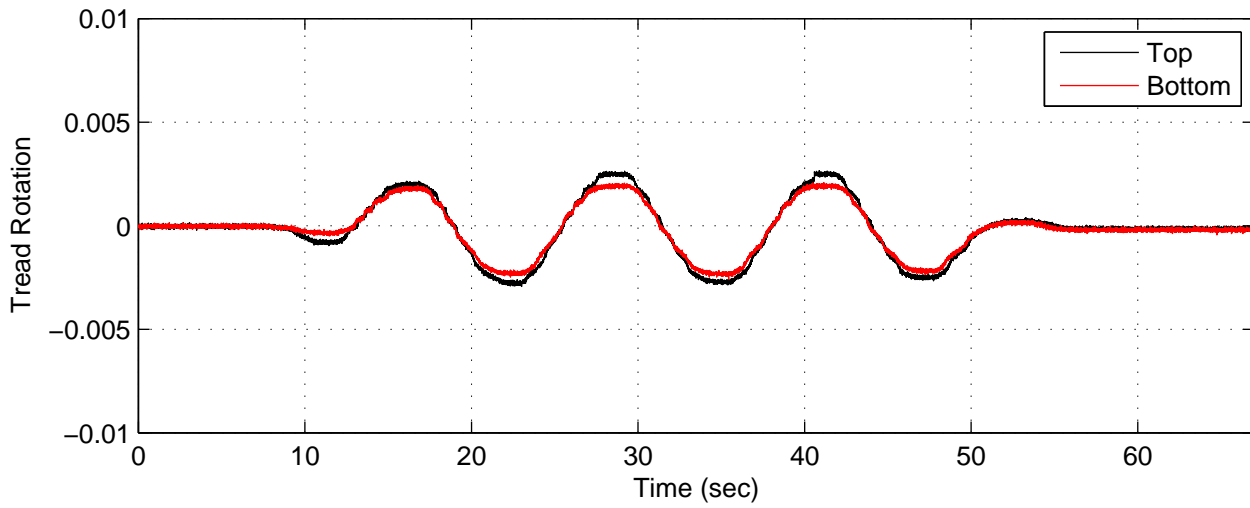
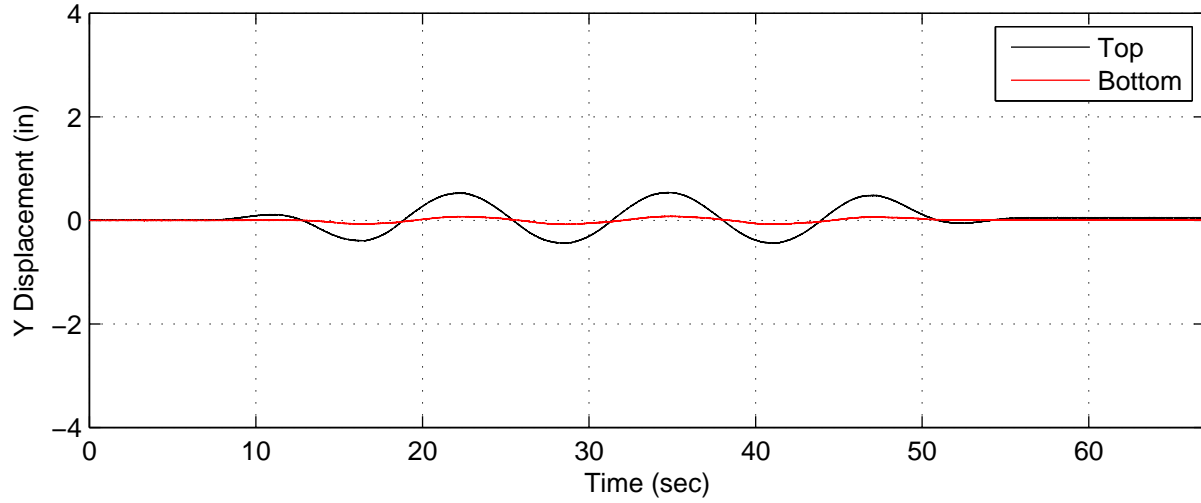
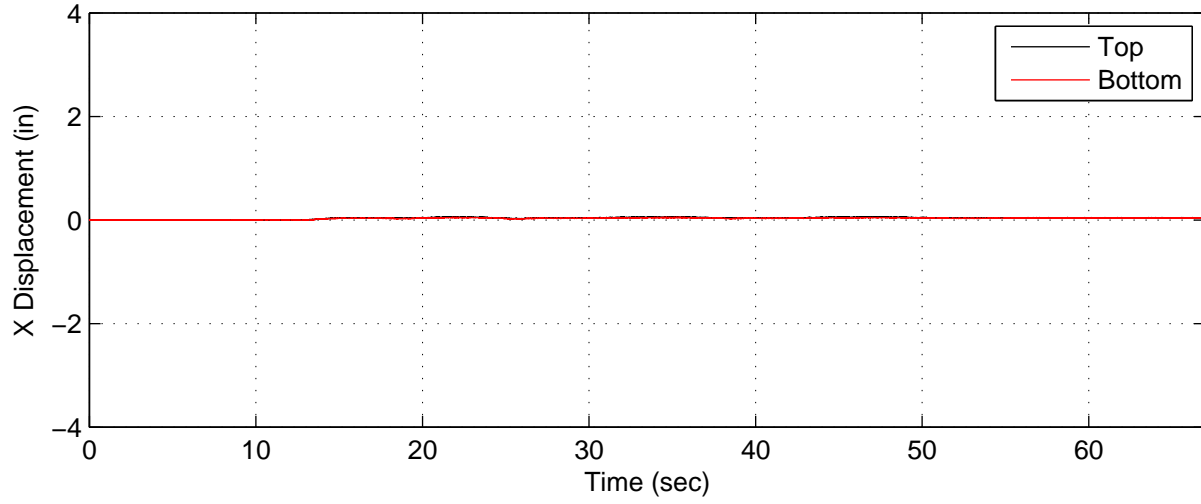

AP4 (Added Mass) – Test C, 0.5in. Quasi-static Y Disp (4 Load Cells)

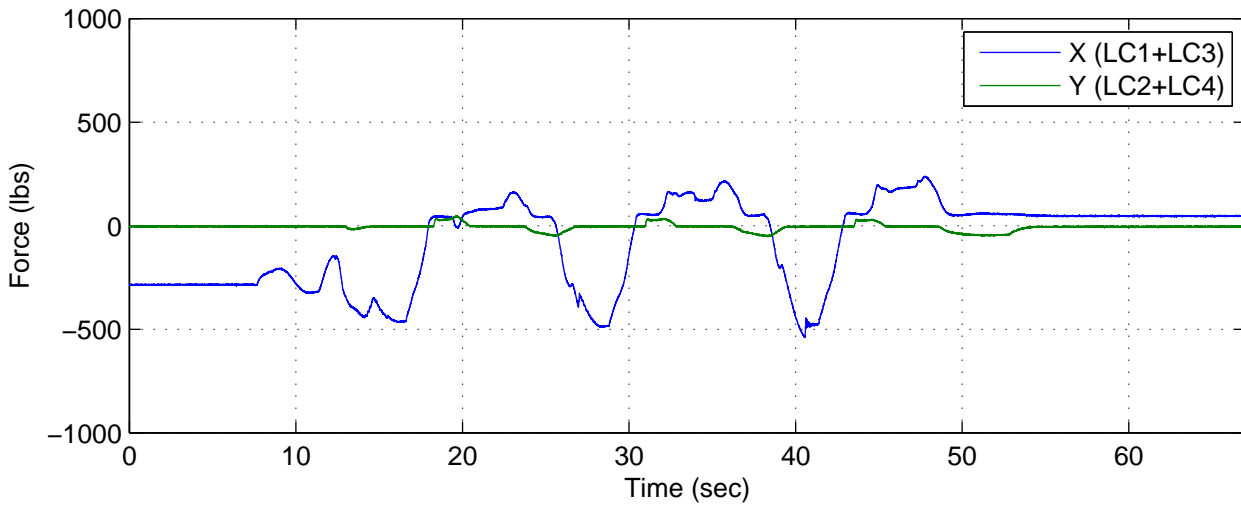
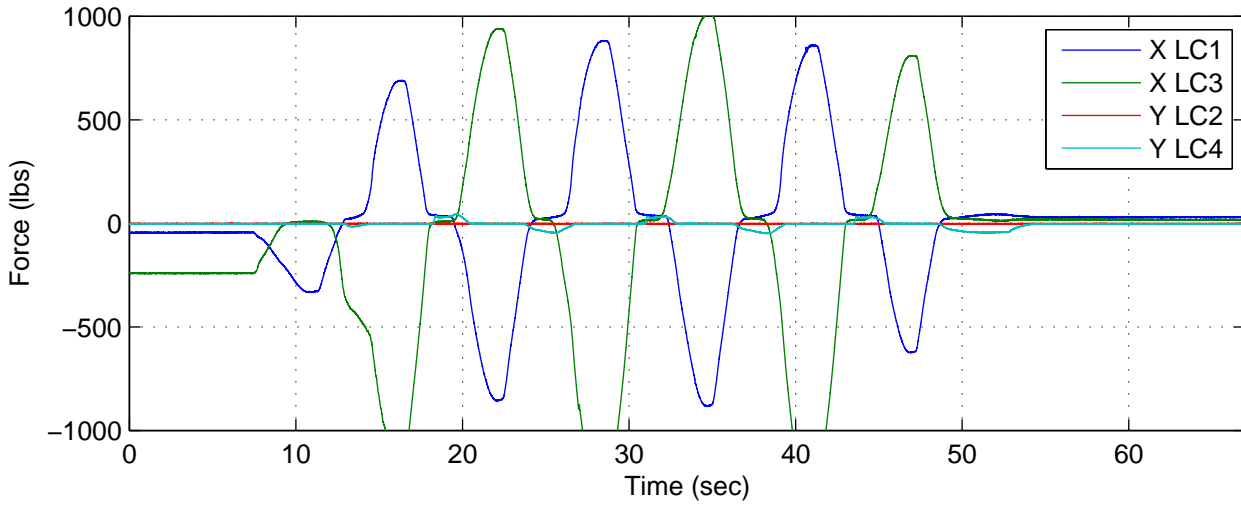
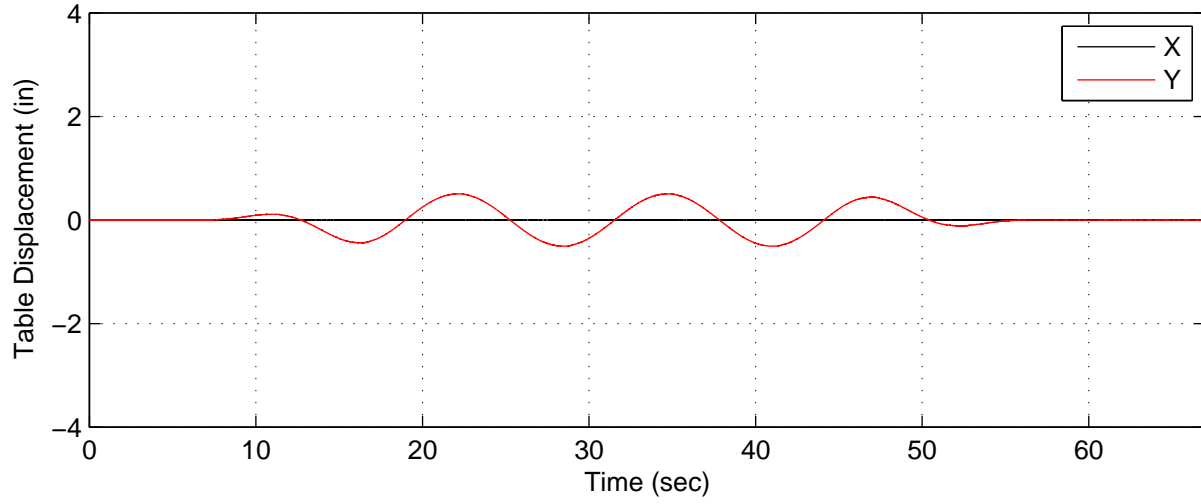

AP4 (Added Mass) – Test C, 0.5in. Quasi-static Y Disp (4 Load Cells)

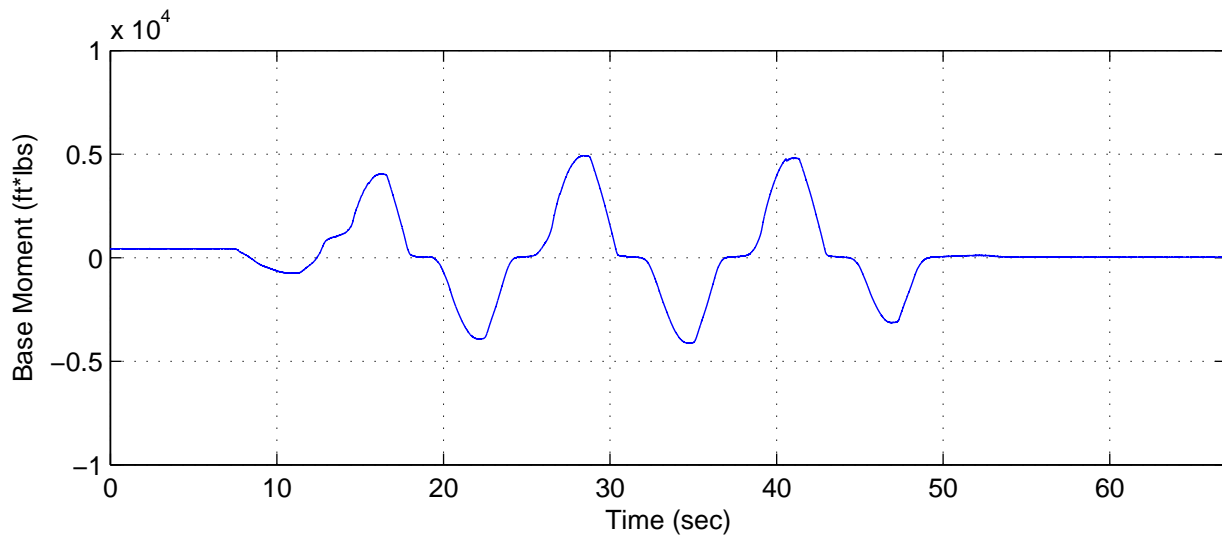
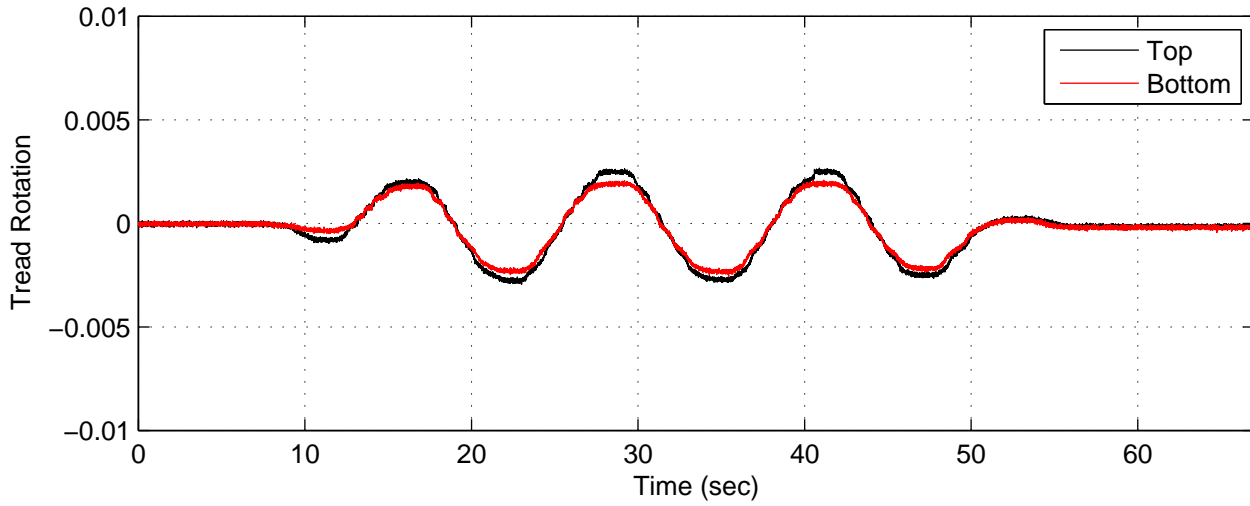
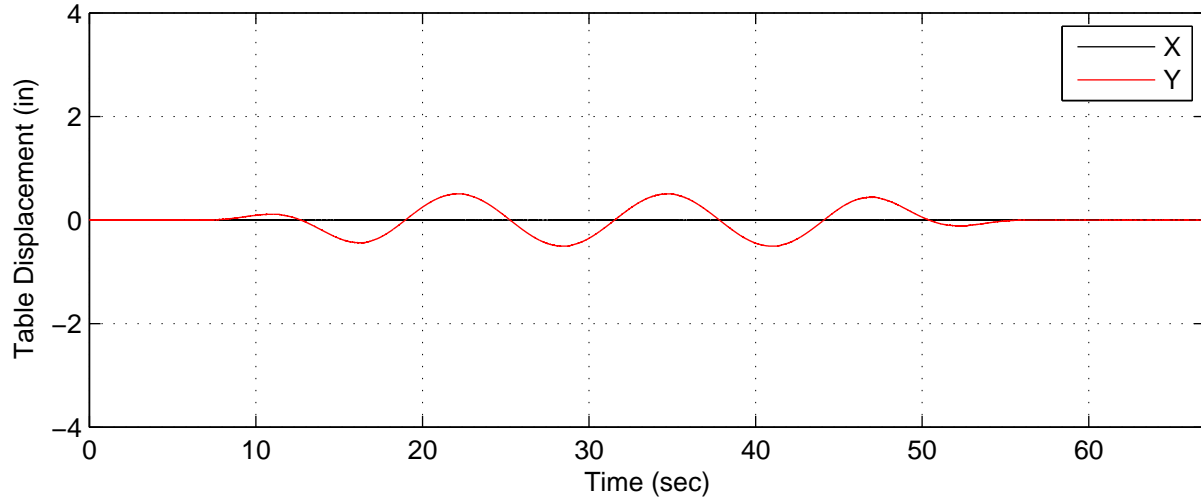

AP4 (Added Mass) – Test D, 2.5in. Quasi-static Y Disp (4 Load Cells)

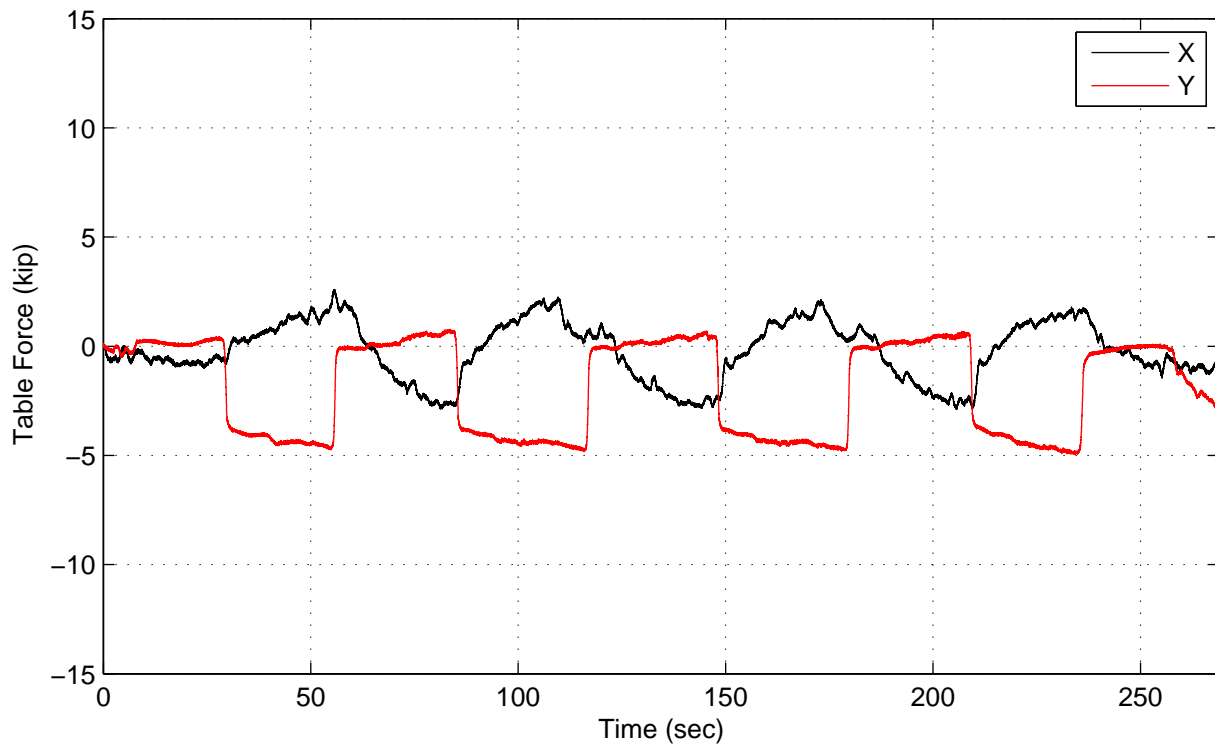
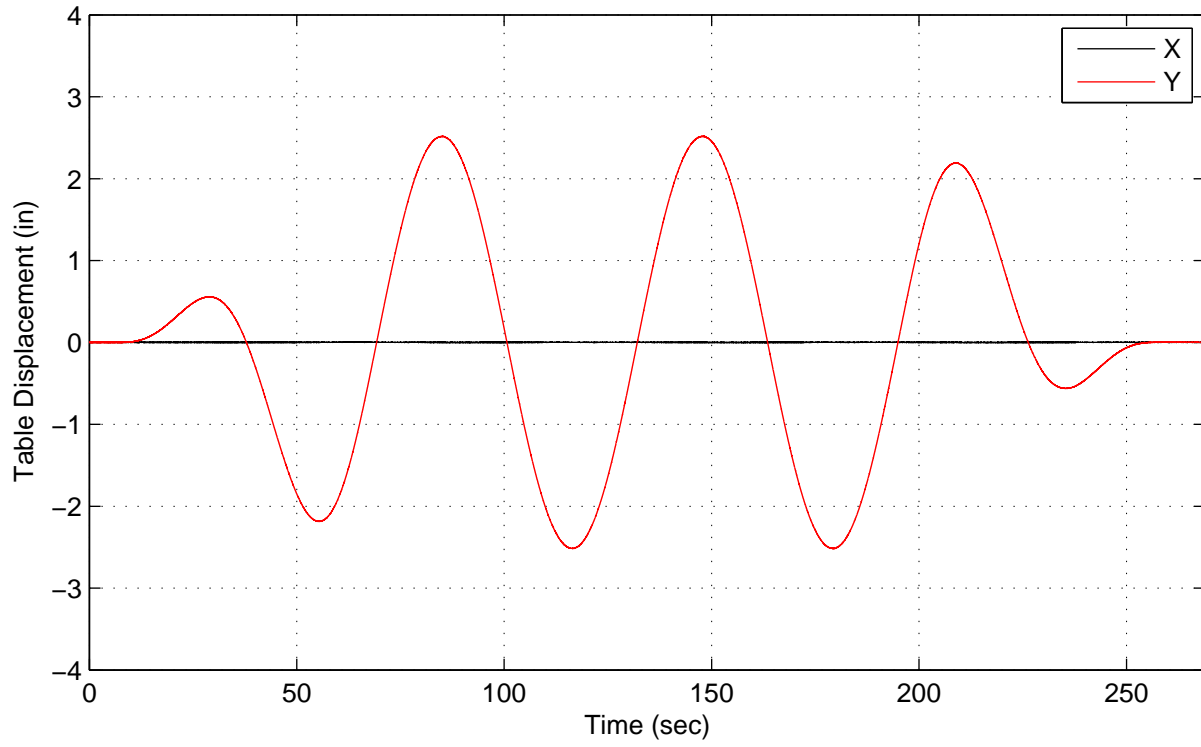

AP4 (Added Mass) – Test D, 2.5in. Quasi-static Y Disp (4 Load Cells)

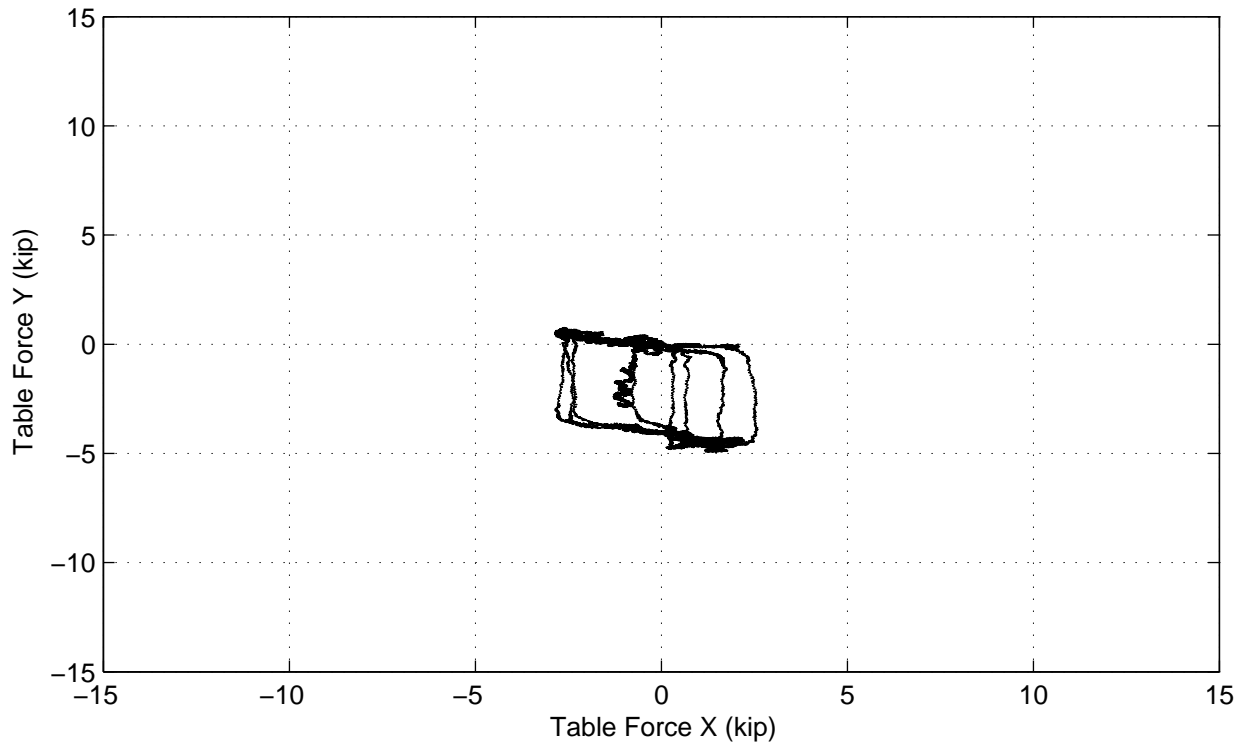
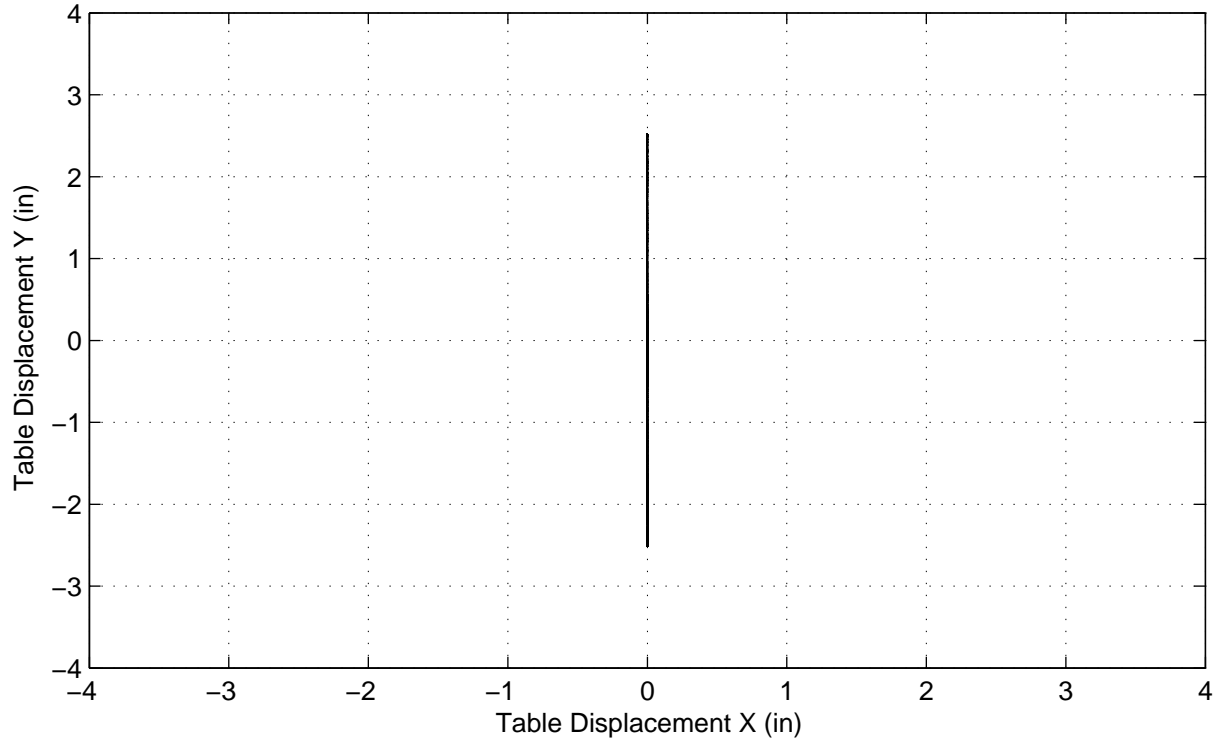

AP4 (Added Mass) – Test D, 2.5in. Quasi-static Y Disp (4 Load Cells)

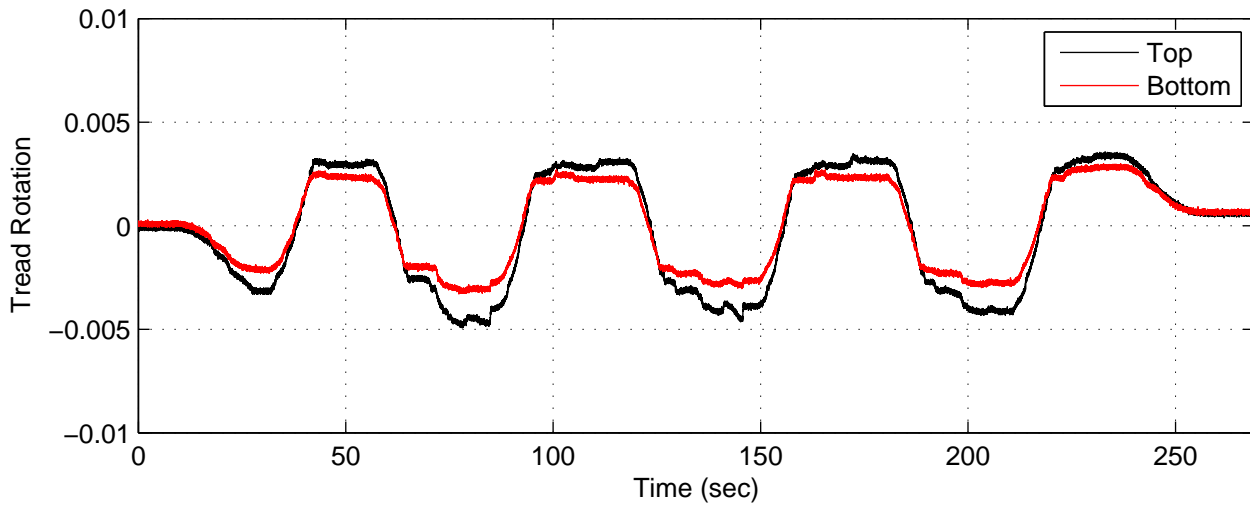
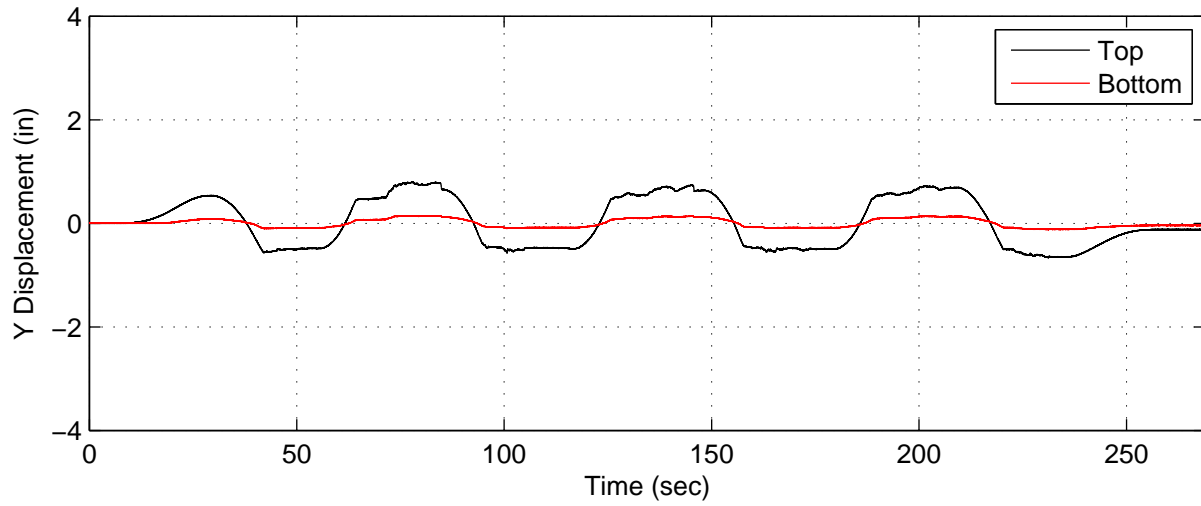
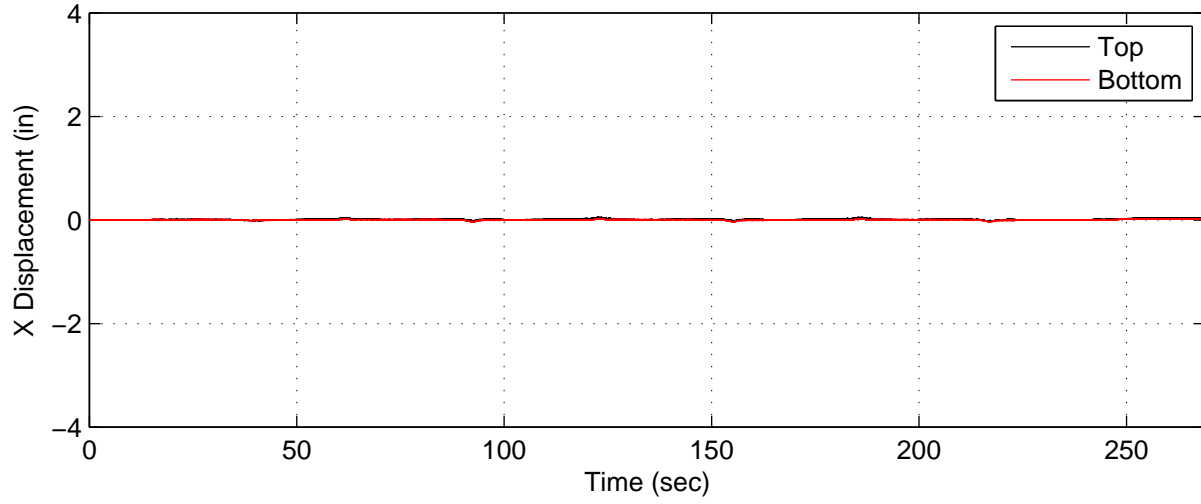

AP4 (Added Mass) – Test D, 2.5in. Quasi-static Y Disp (4 Load Cells)

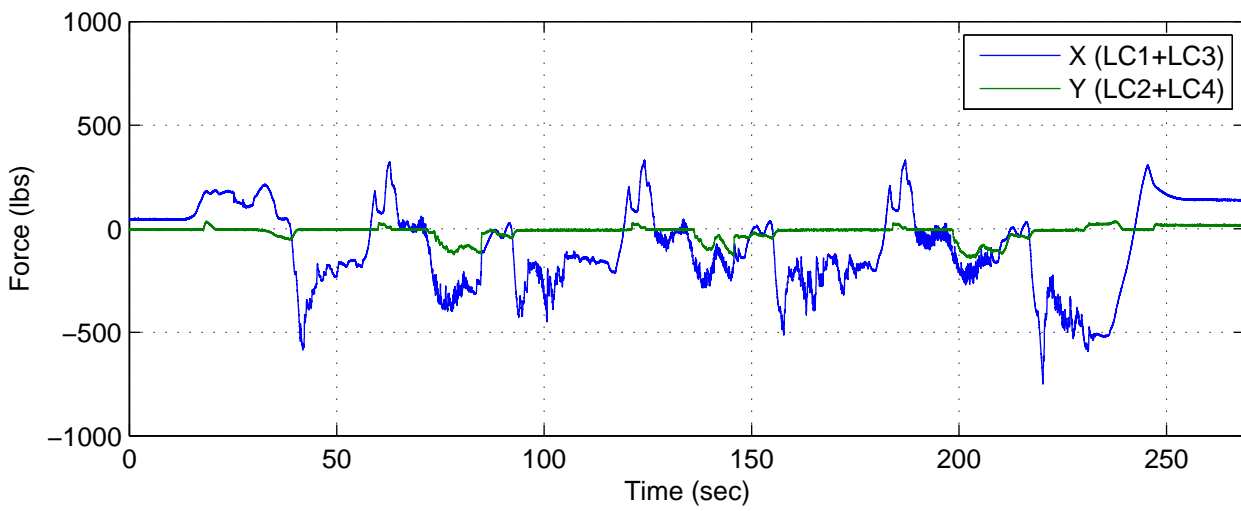
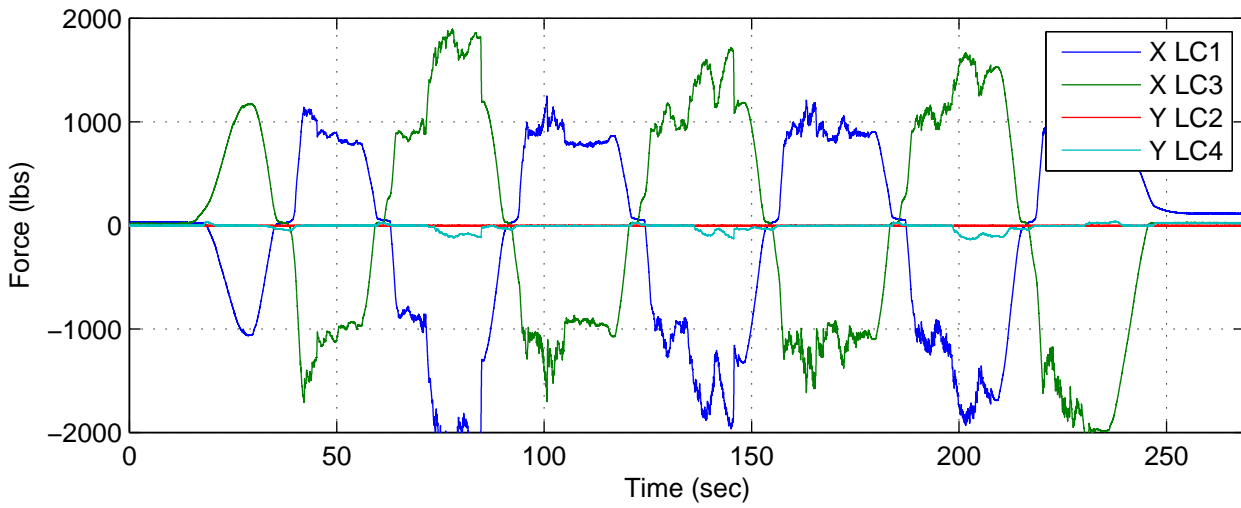
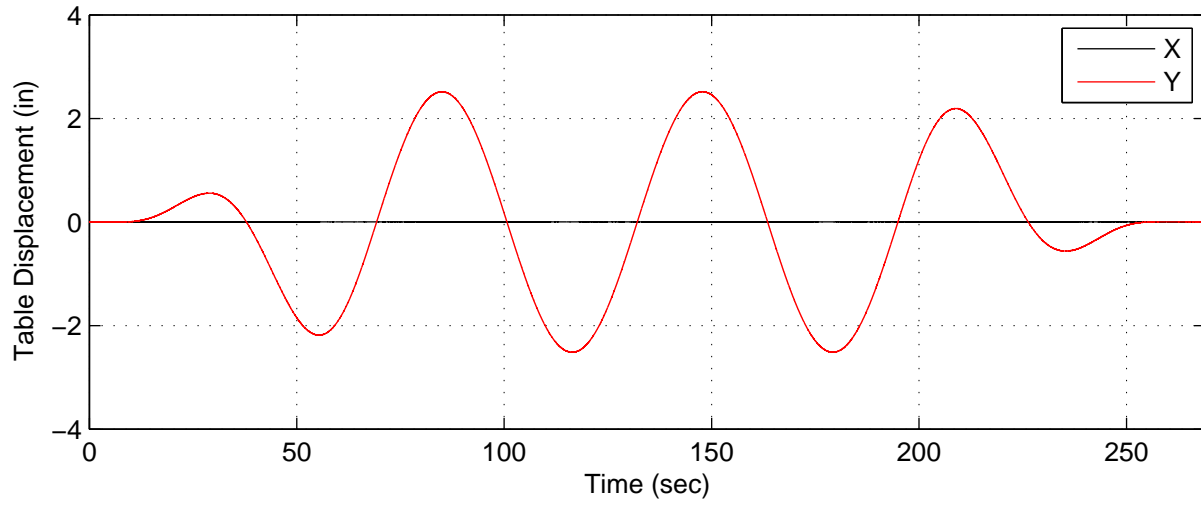



AP4 (Added Mass) – Test D, 2.5in. Quasi-static Y Disp (4 Load Cells)

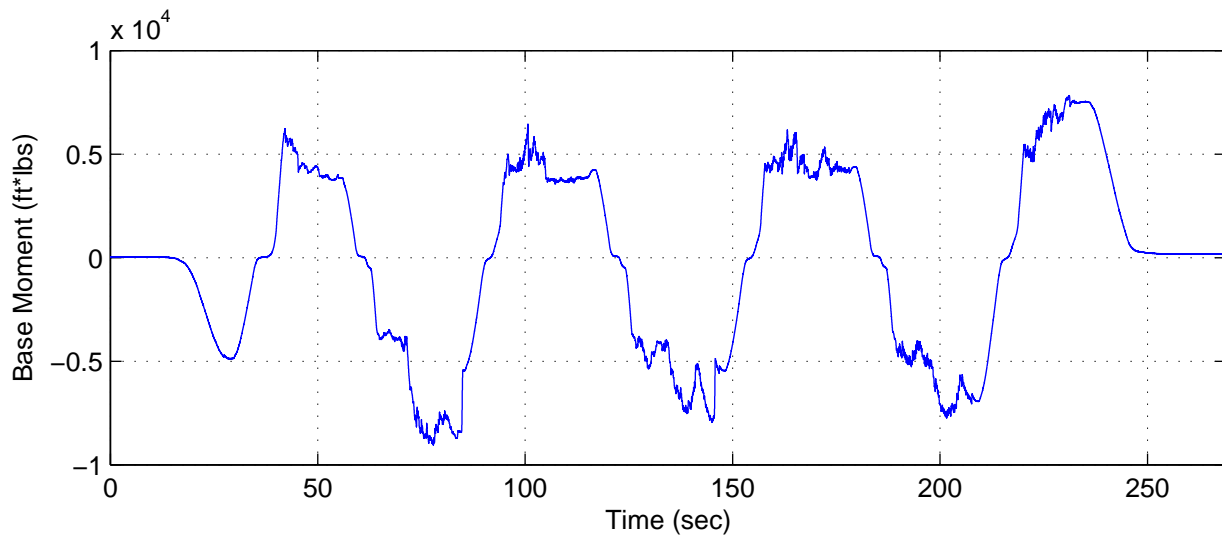
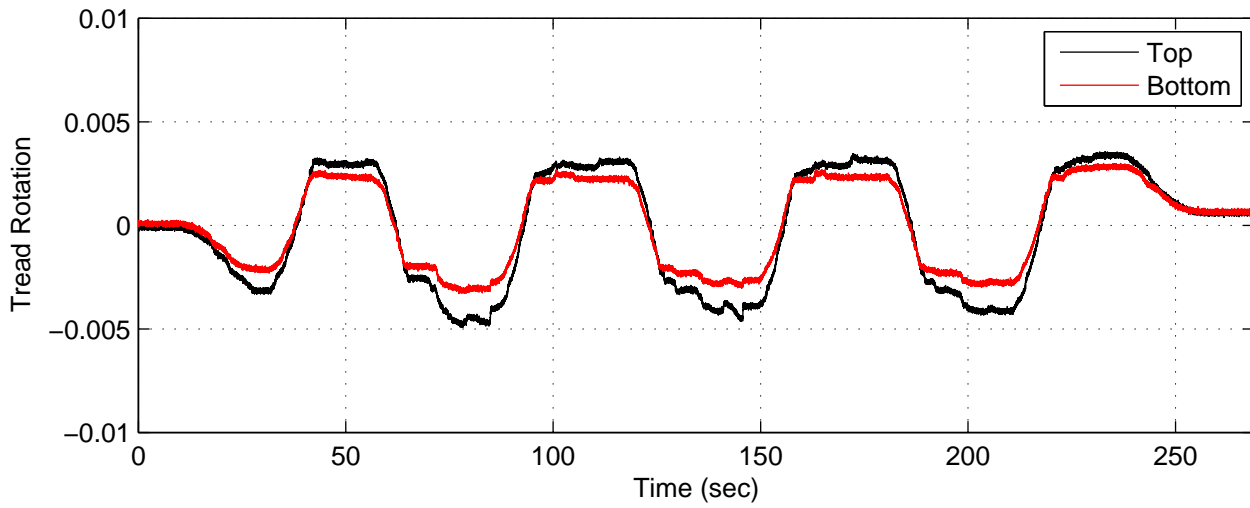
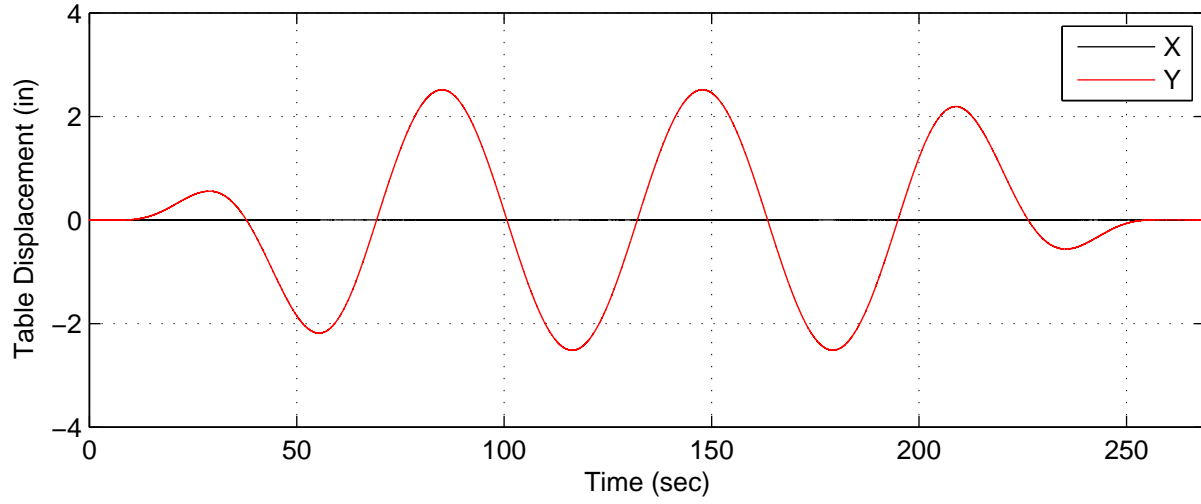

AP4 (Added Mass) – Test A, 0.5in. Quasi-static X Disp

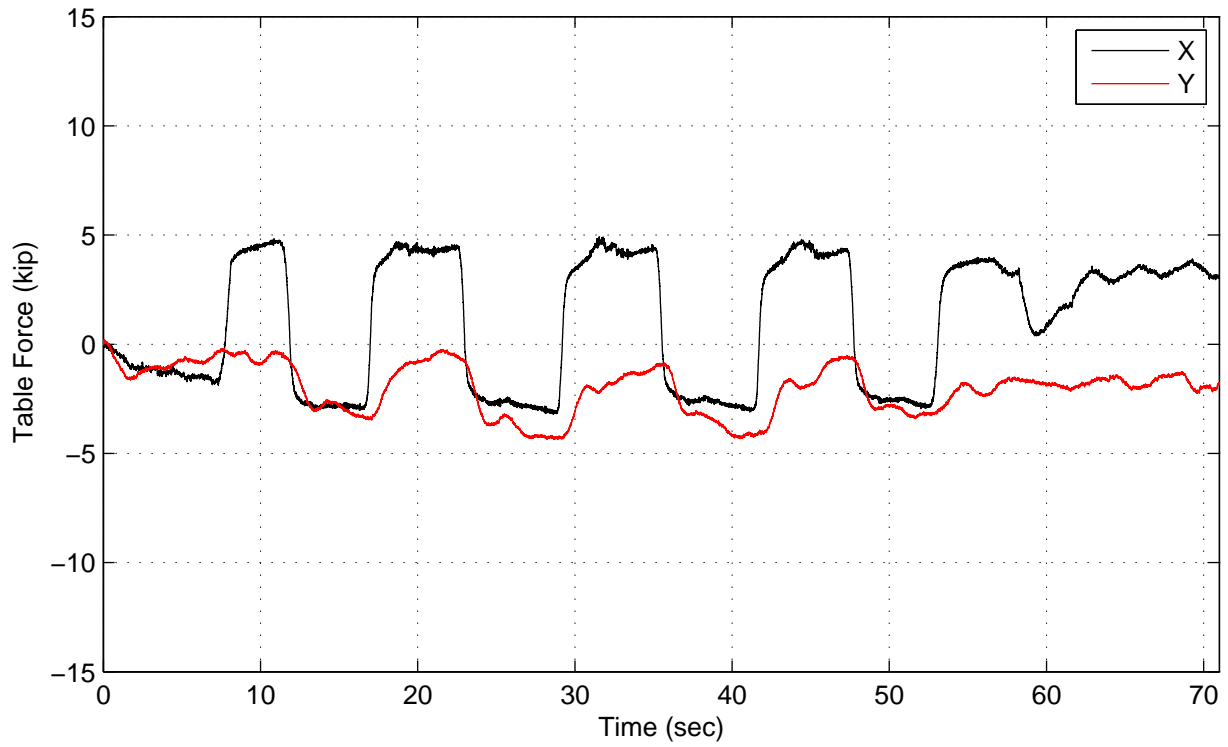
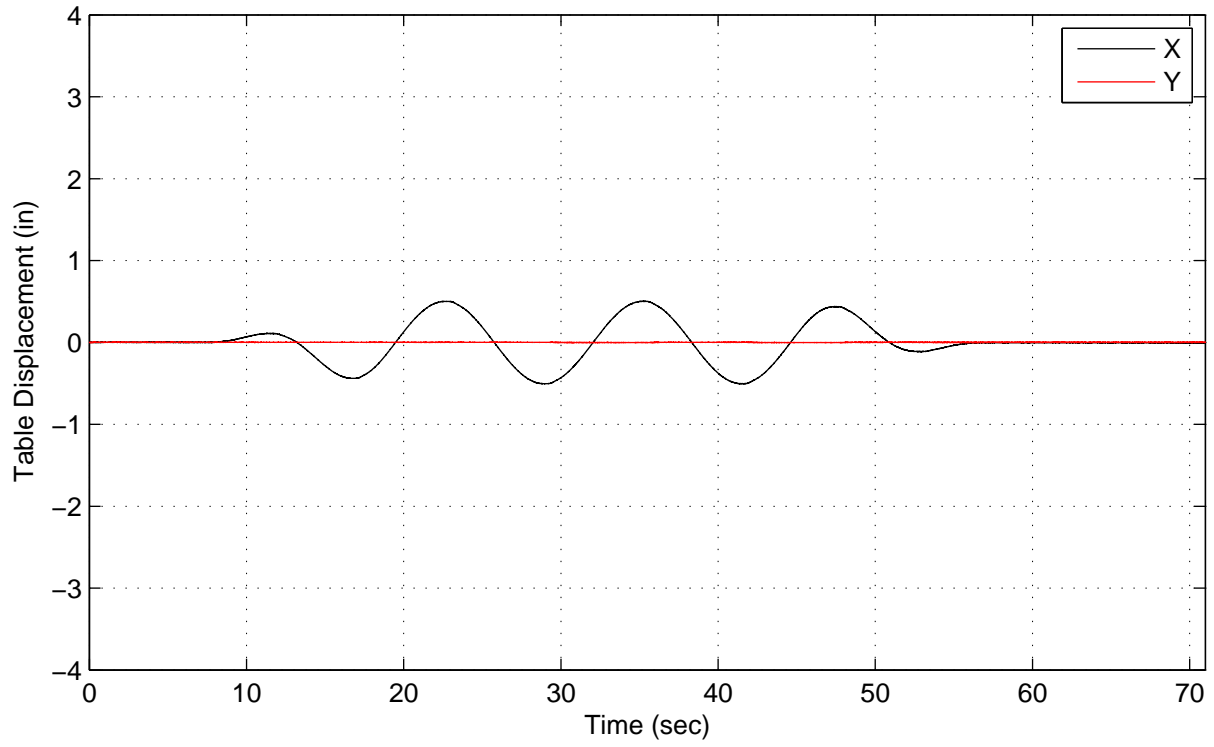

AP4 (Added Mass) – Test A, 0.5in. Quasi-static X Disp

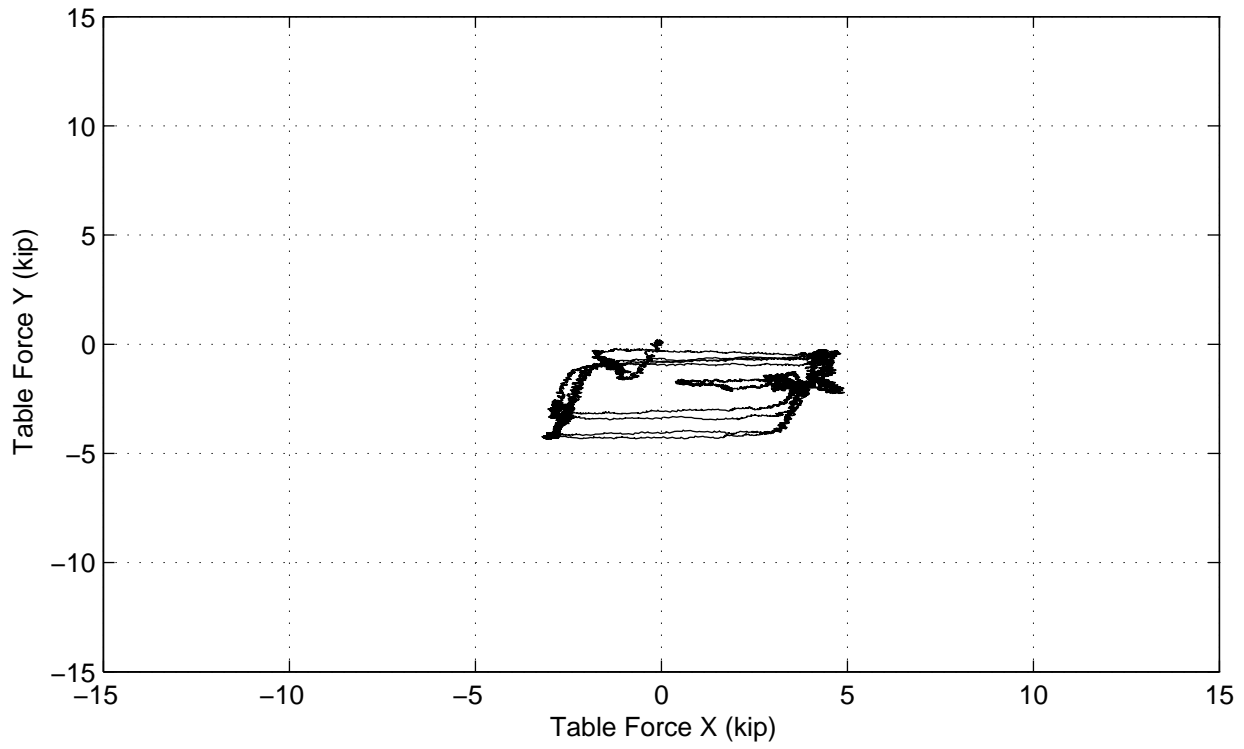
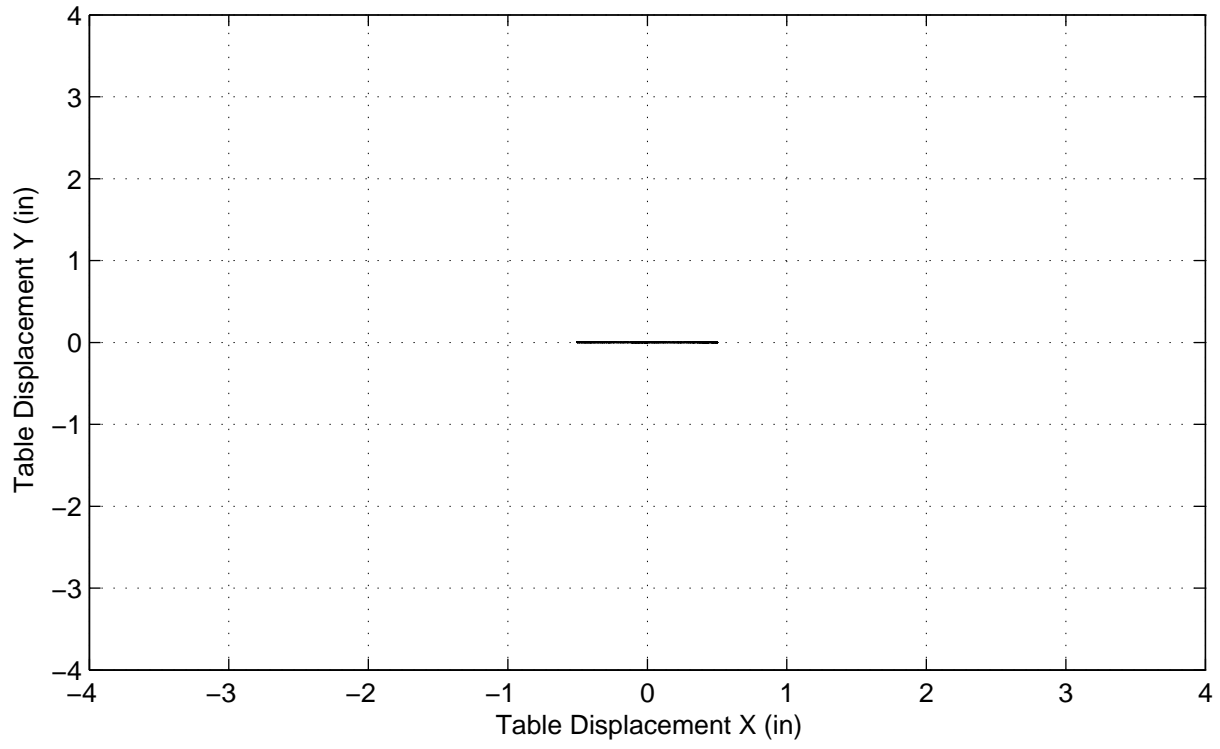

AP4 (Added Mass) – Test A, 0.5in. Quasi-static X Disp

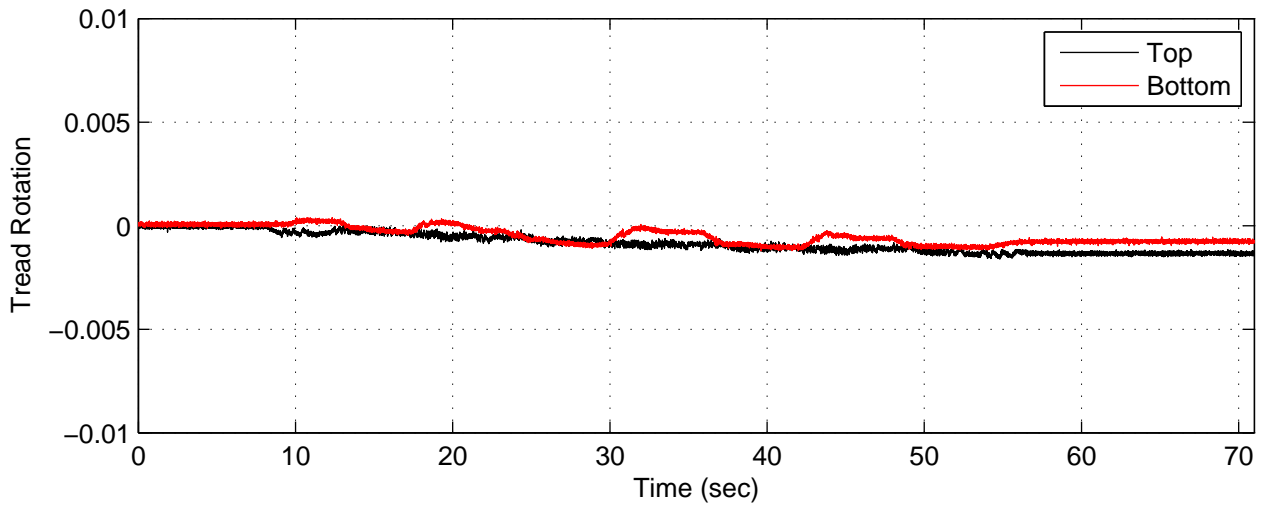
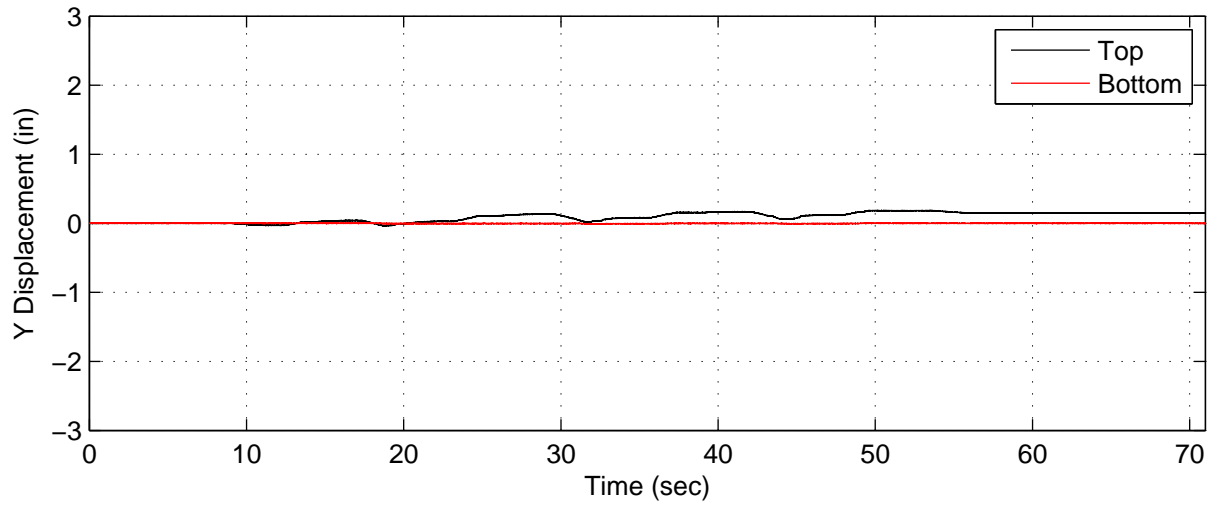
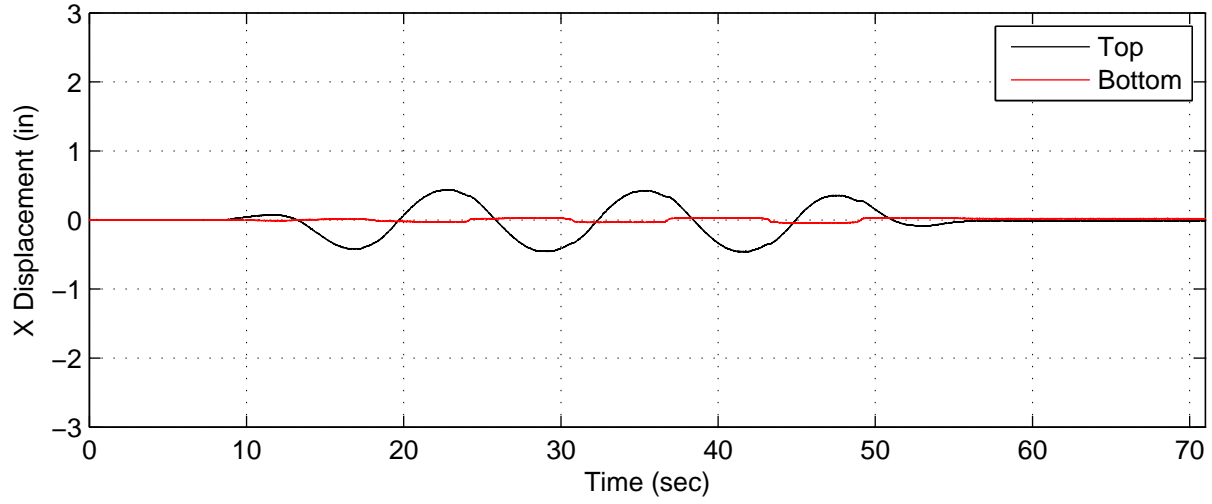

AP4 (Added Mass) – Test A, 0.5in. Quasi-static X Disp

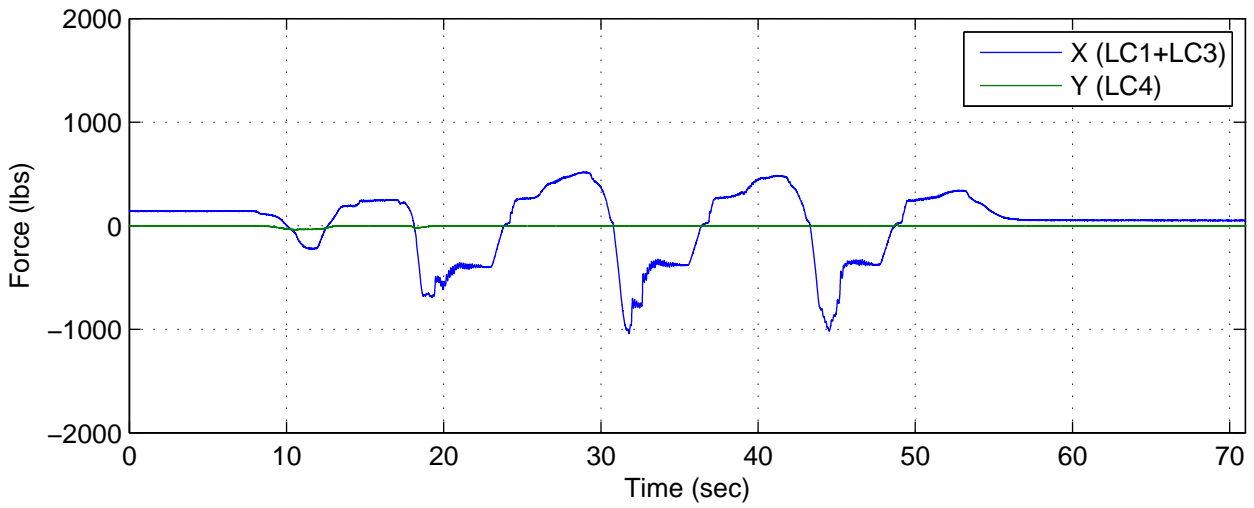
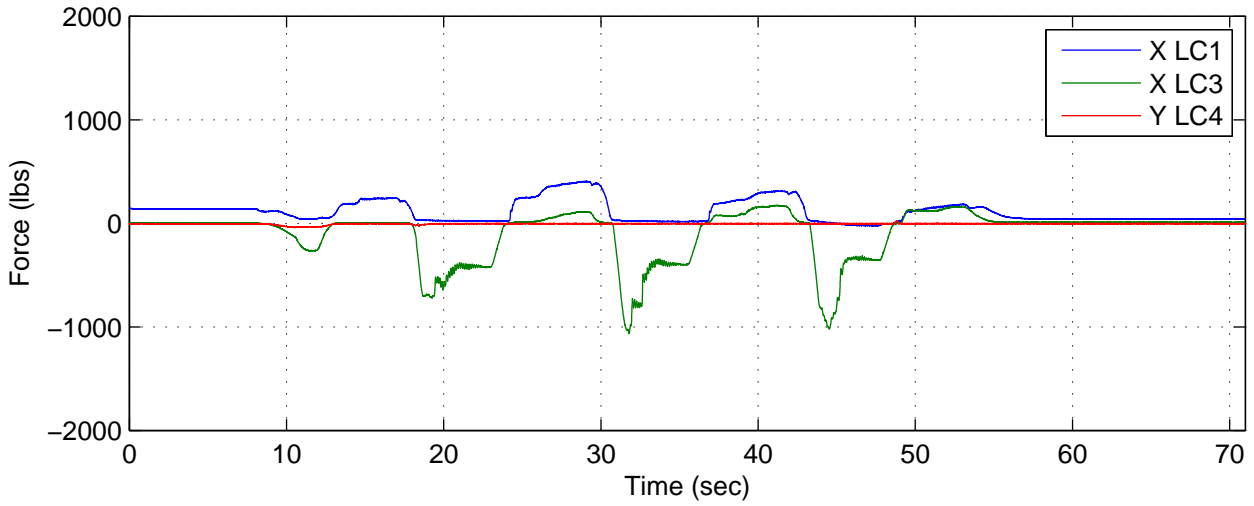
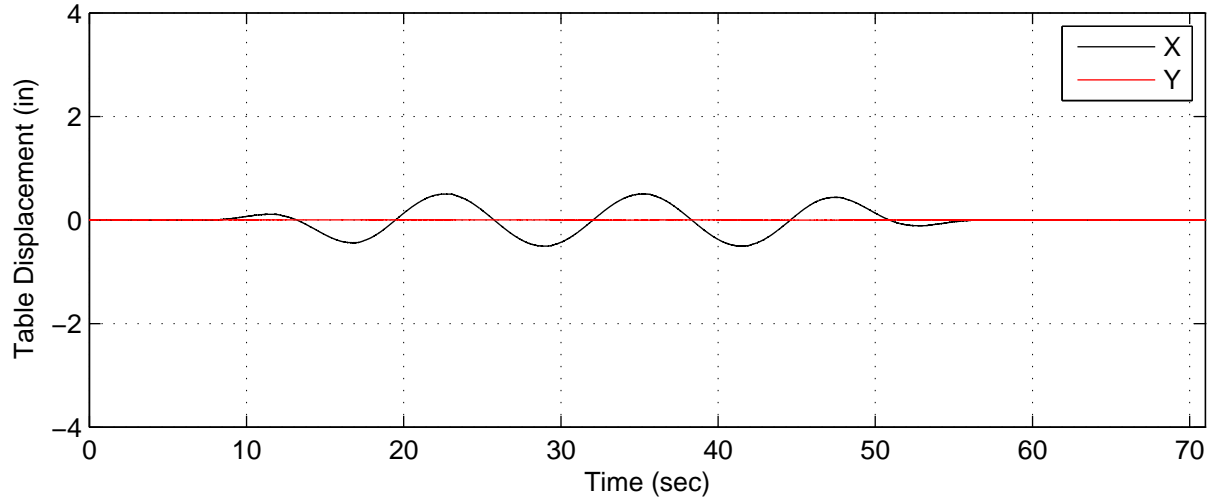

AP4 (Added Mass) – Test A, 0.5in. Quasi-static X Disp

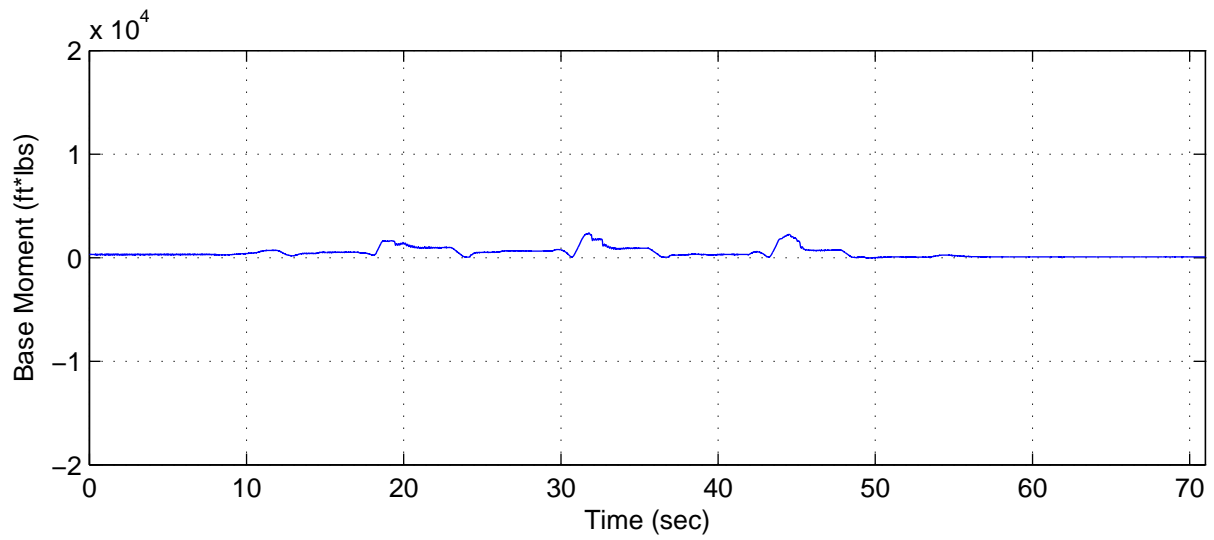
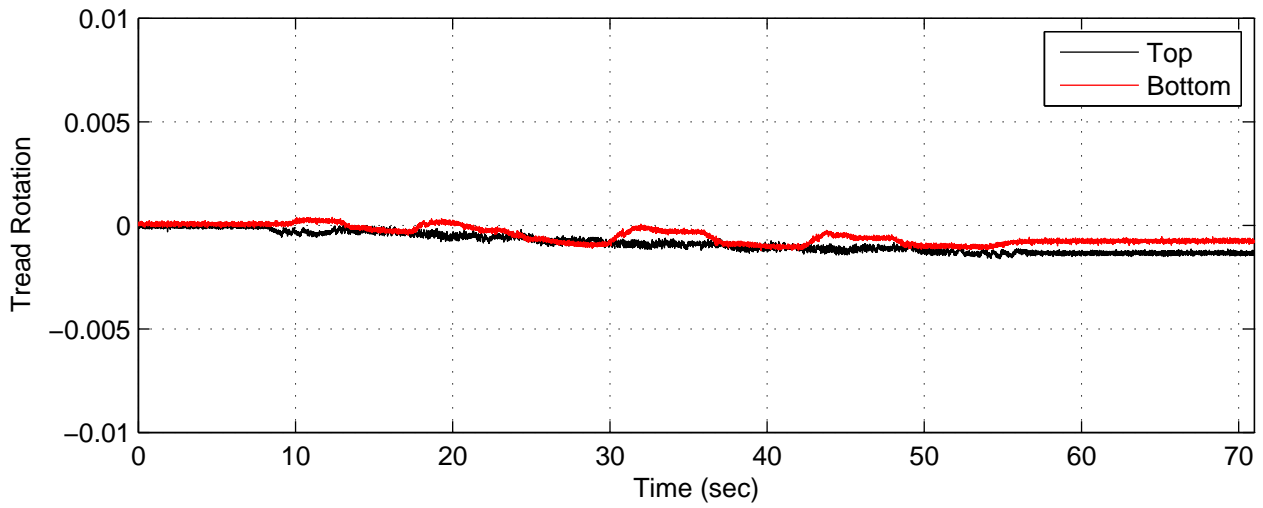
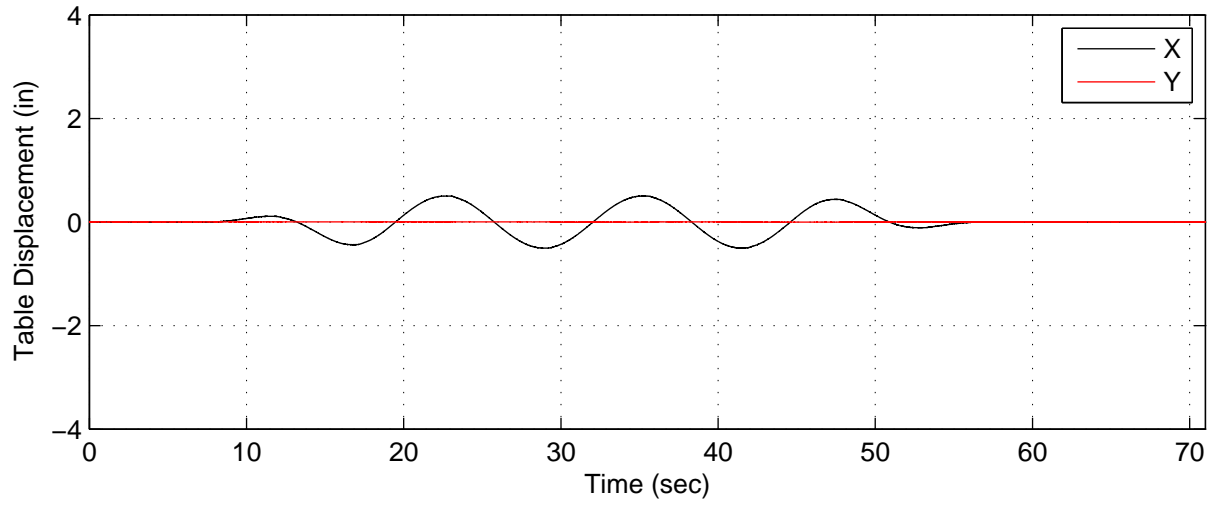

AP4 (Added Mass) – Test B, 2.5in. Quasi-static X Disp

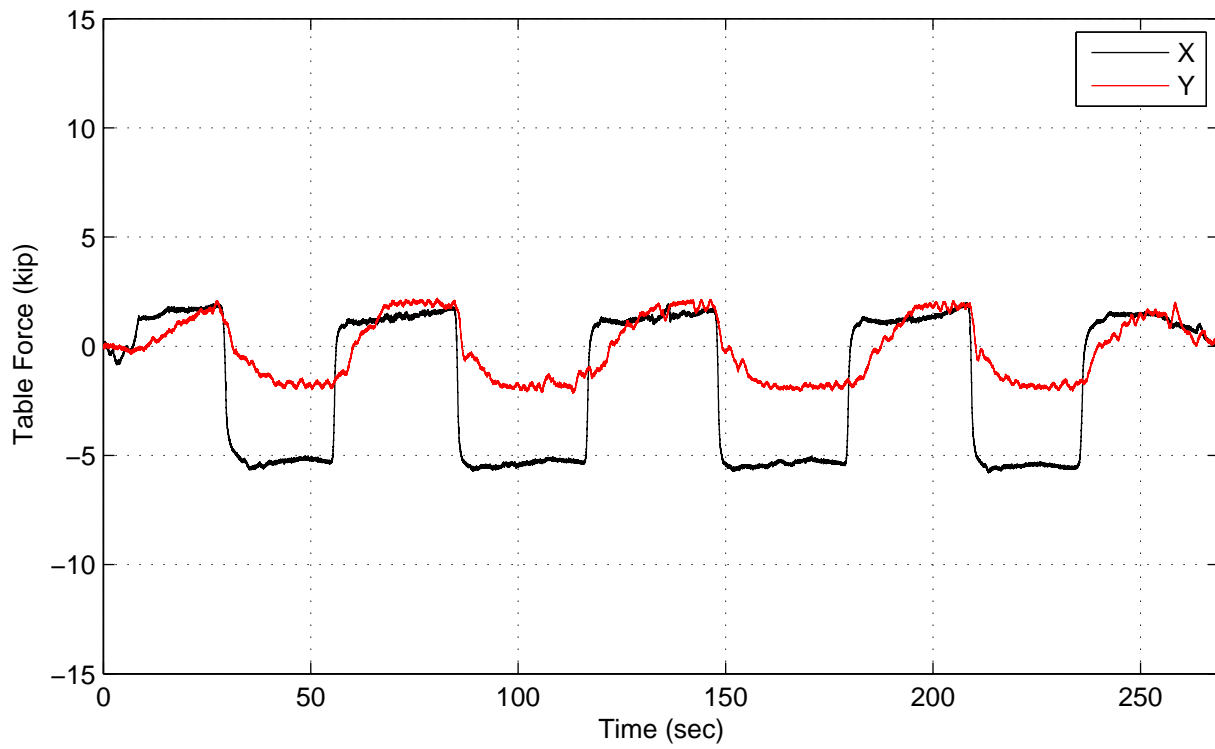
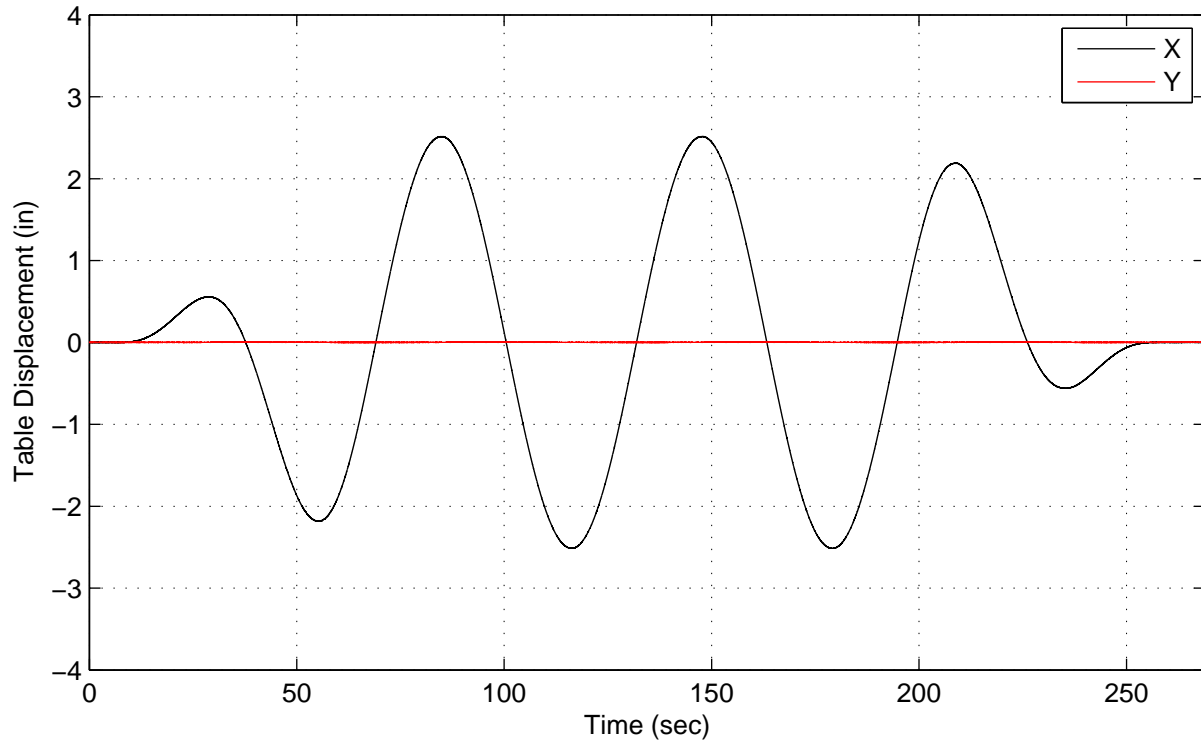

AP4 (Added Mass) – Test B, 2.5in. Quasi-static X Disp

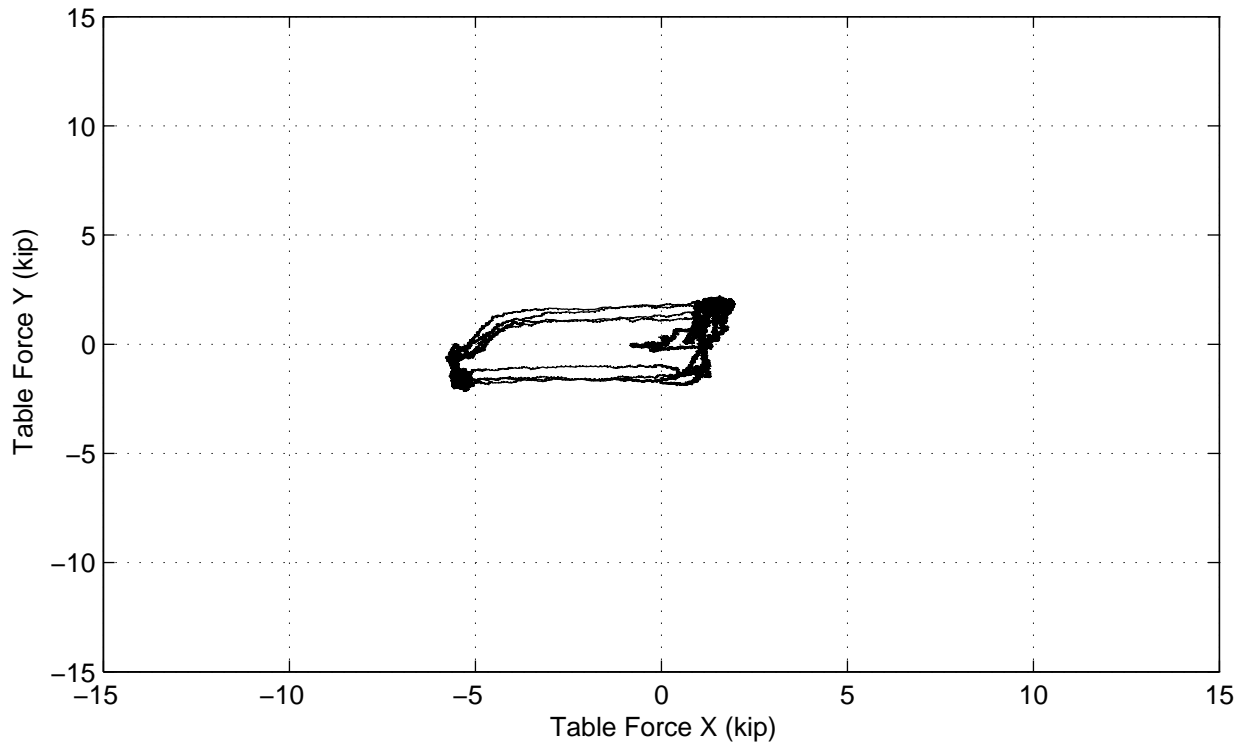
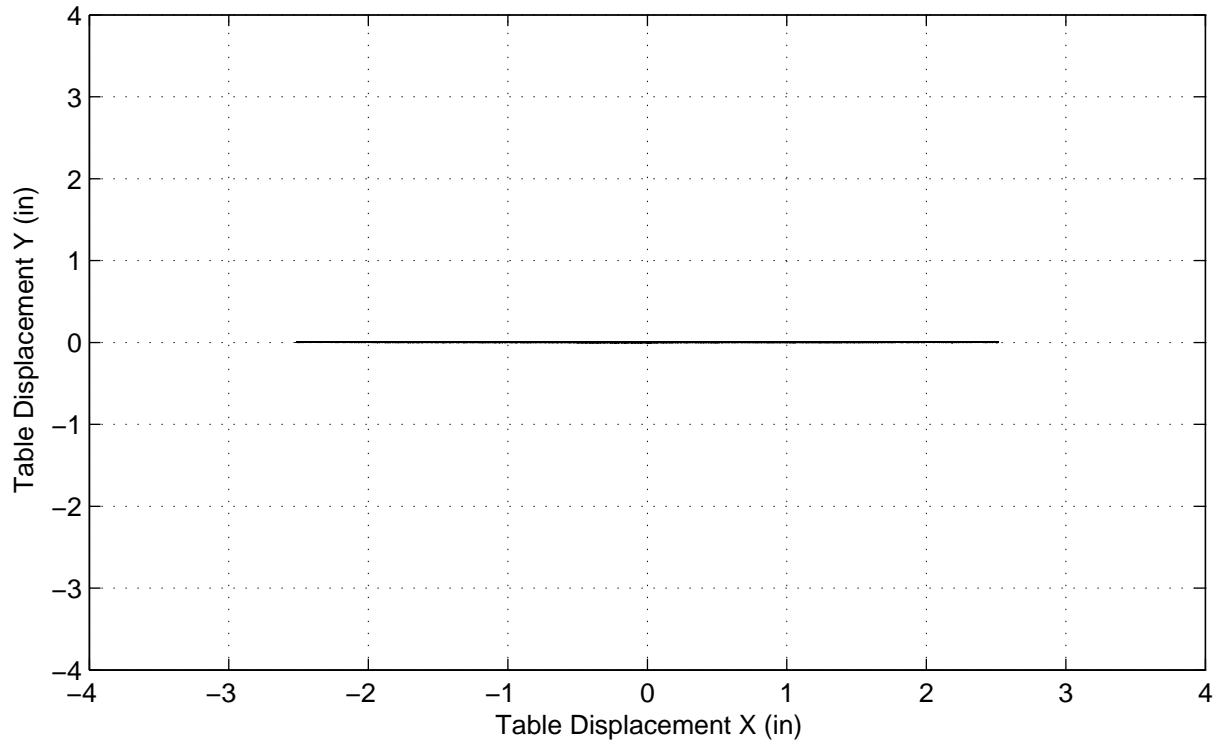



AP4 (Added Mass) – Test B, 2.5in. Quasi-static X Disp

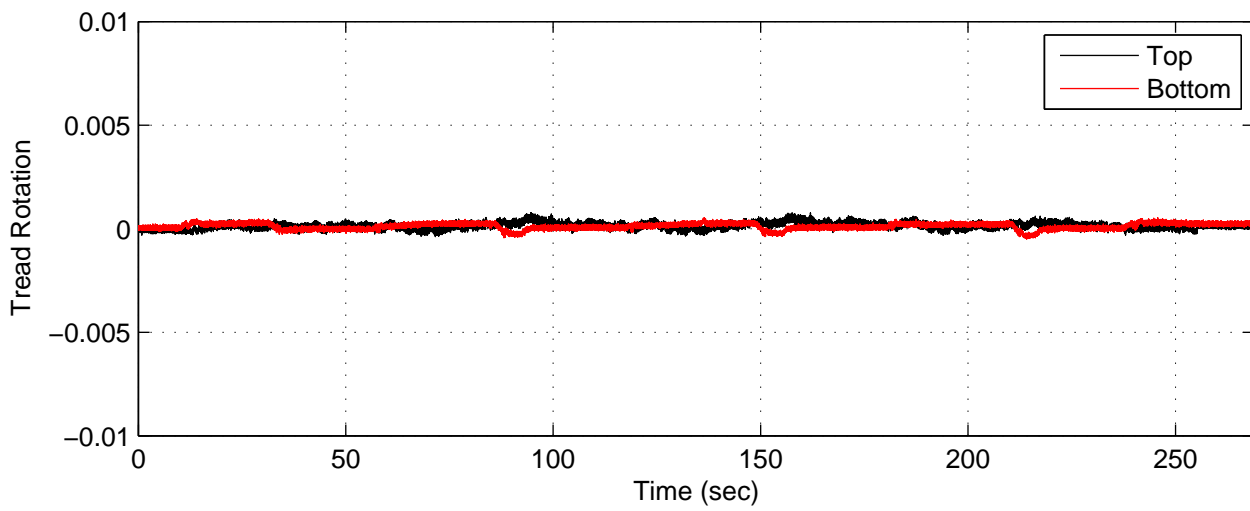
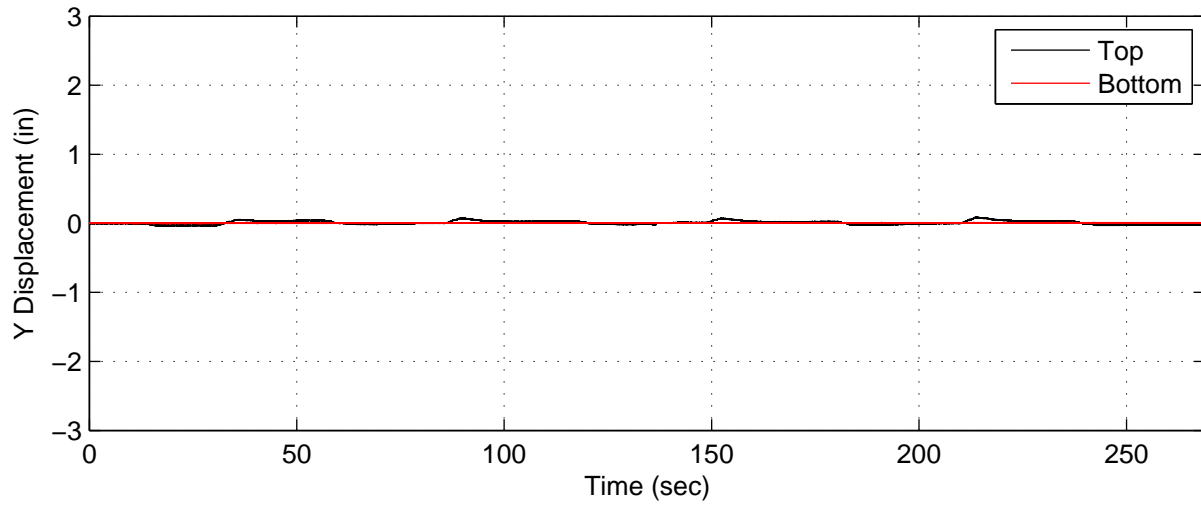
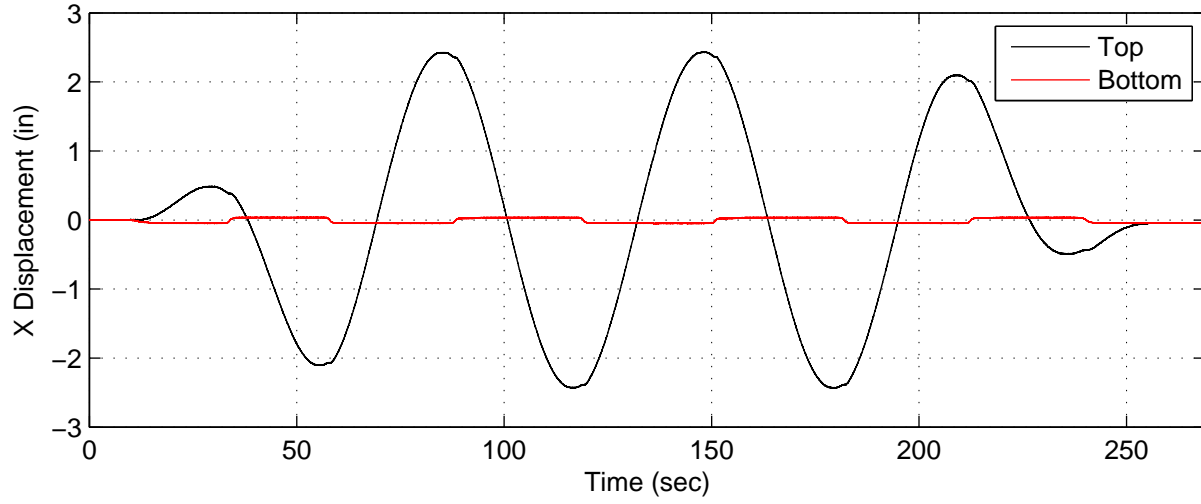

AP4 (Added Mass) – Test B, 2.5in. Quasi-static X Disp

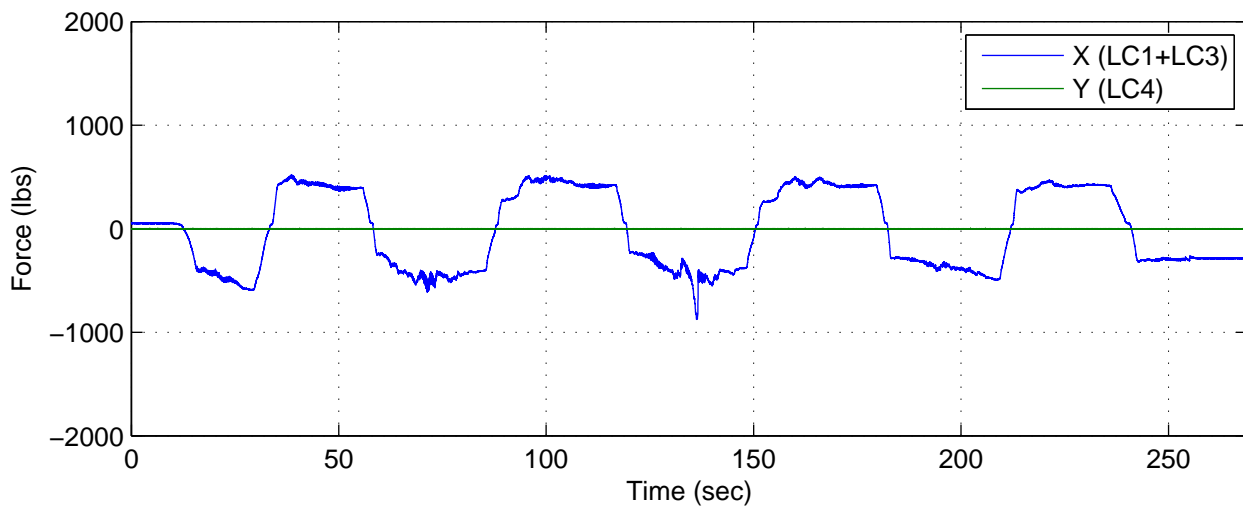
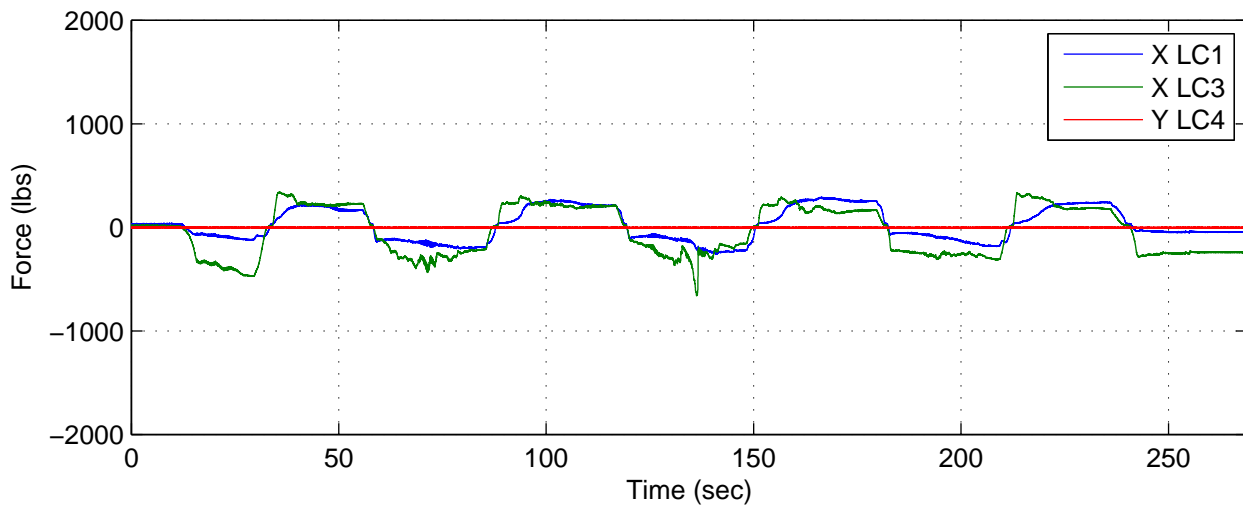
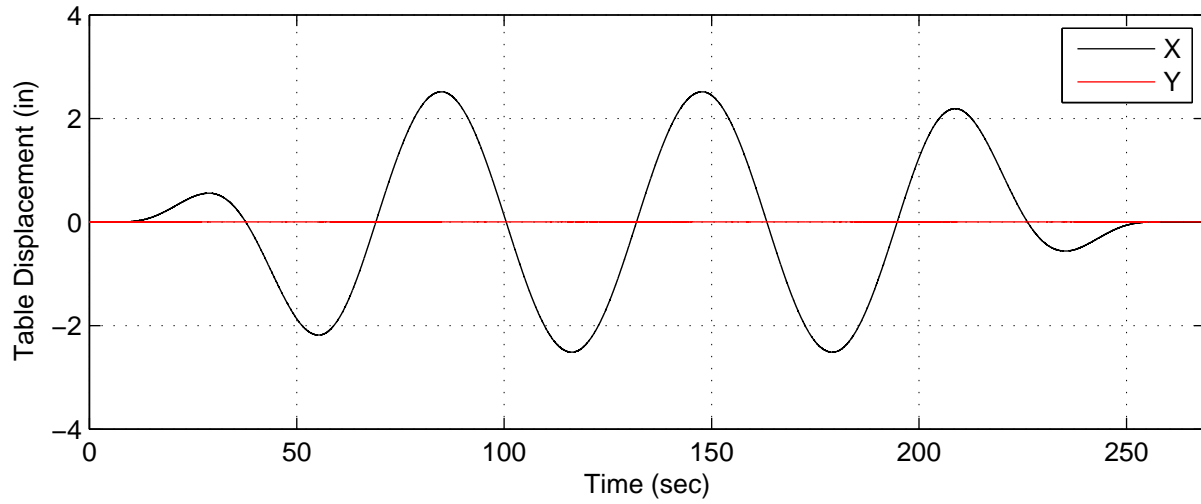

AP4 (Added Mass) – Test B, 2.5in. Quasi-static X Disp

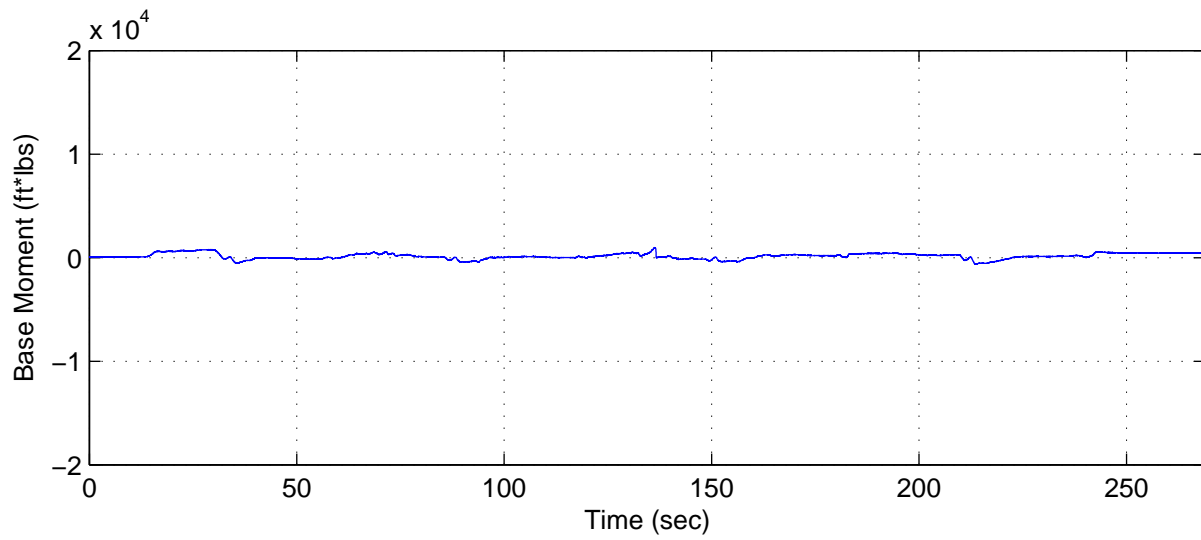
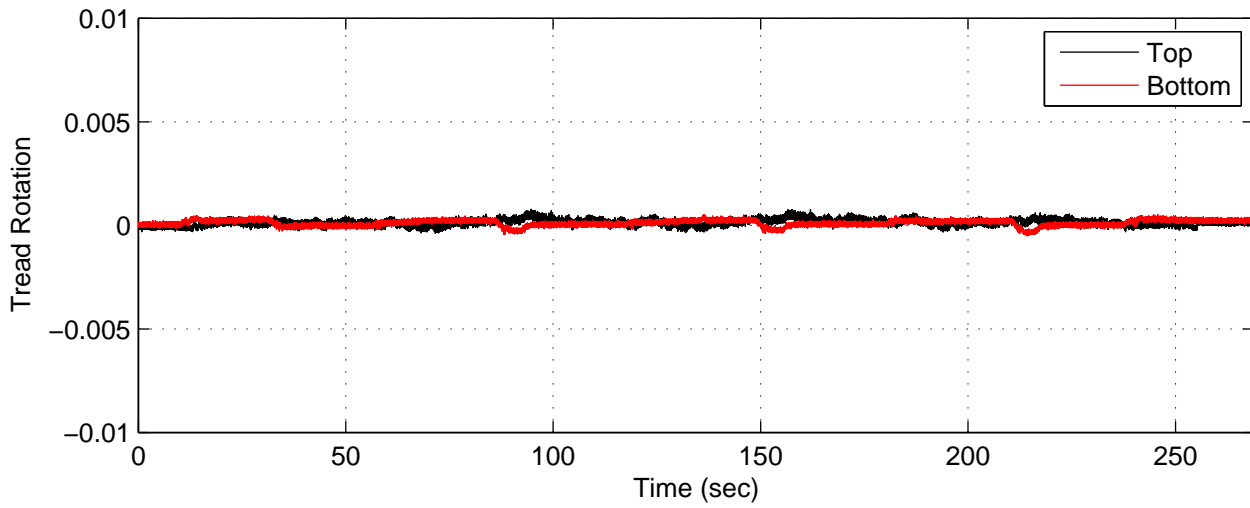
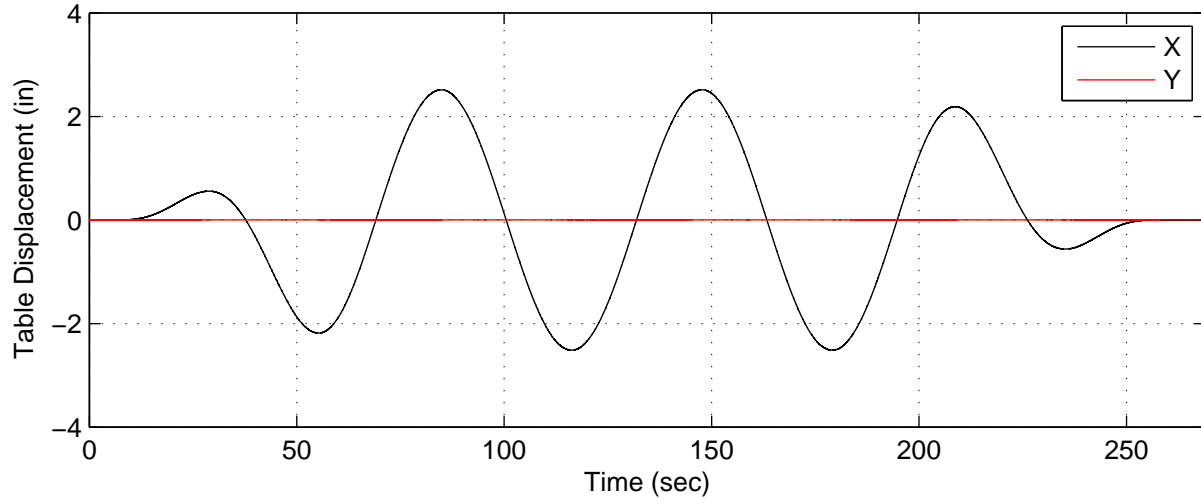

AP4 (Added Mass) – Test C, 0.5in. Quasi-static Y Disp

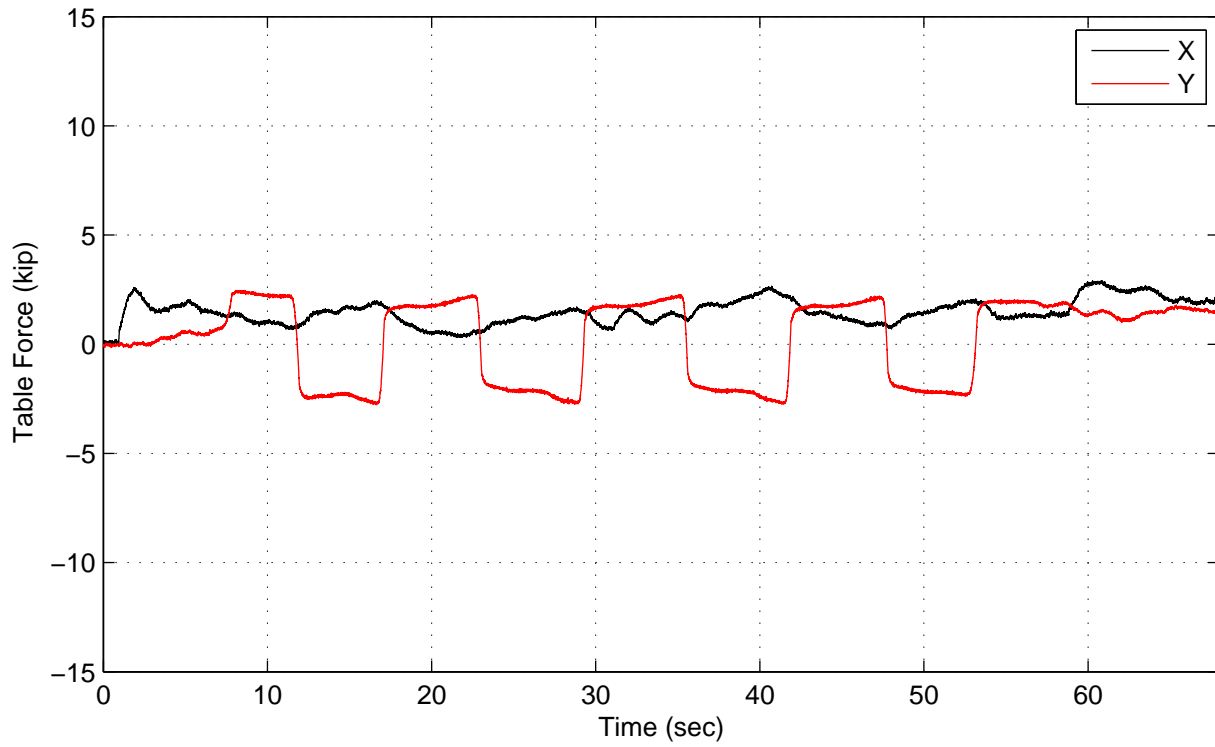
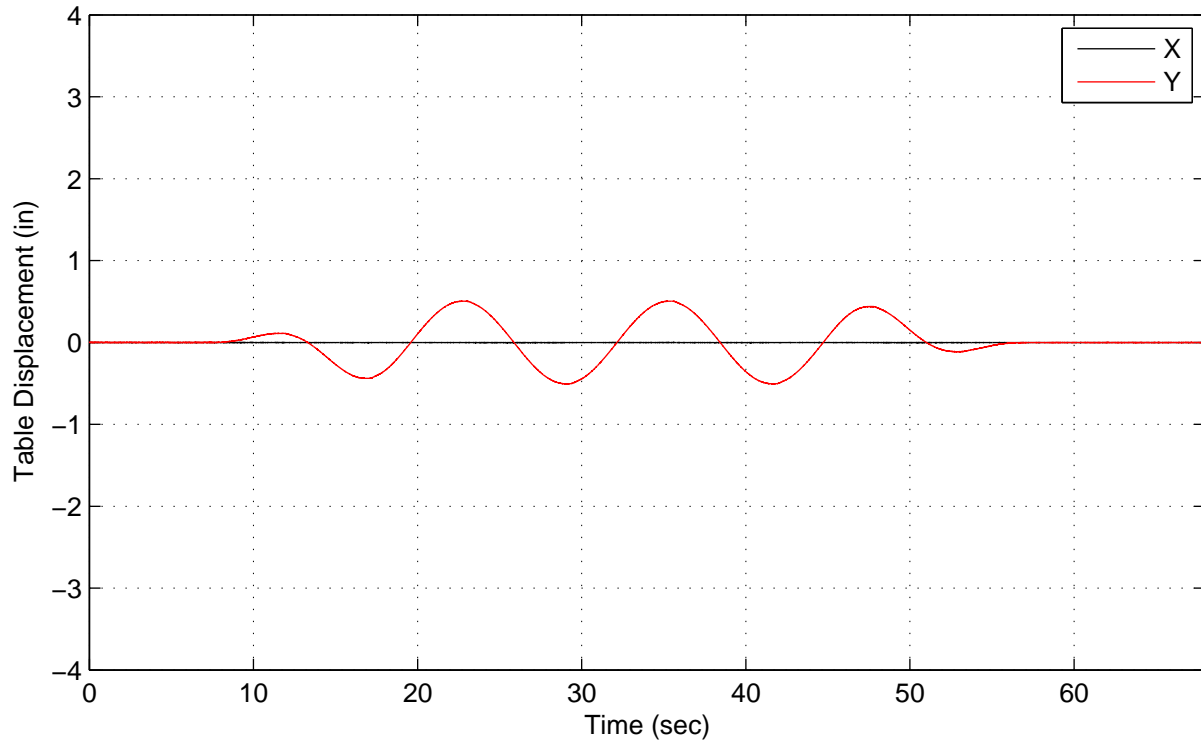

AP4 (Added Mass) – Test C, 0.5in. Quasi-static Y Disp

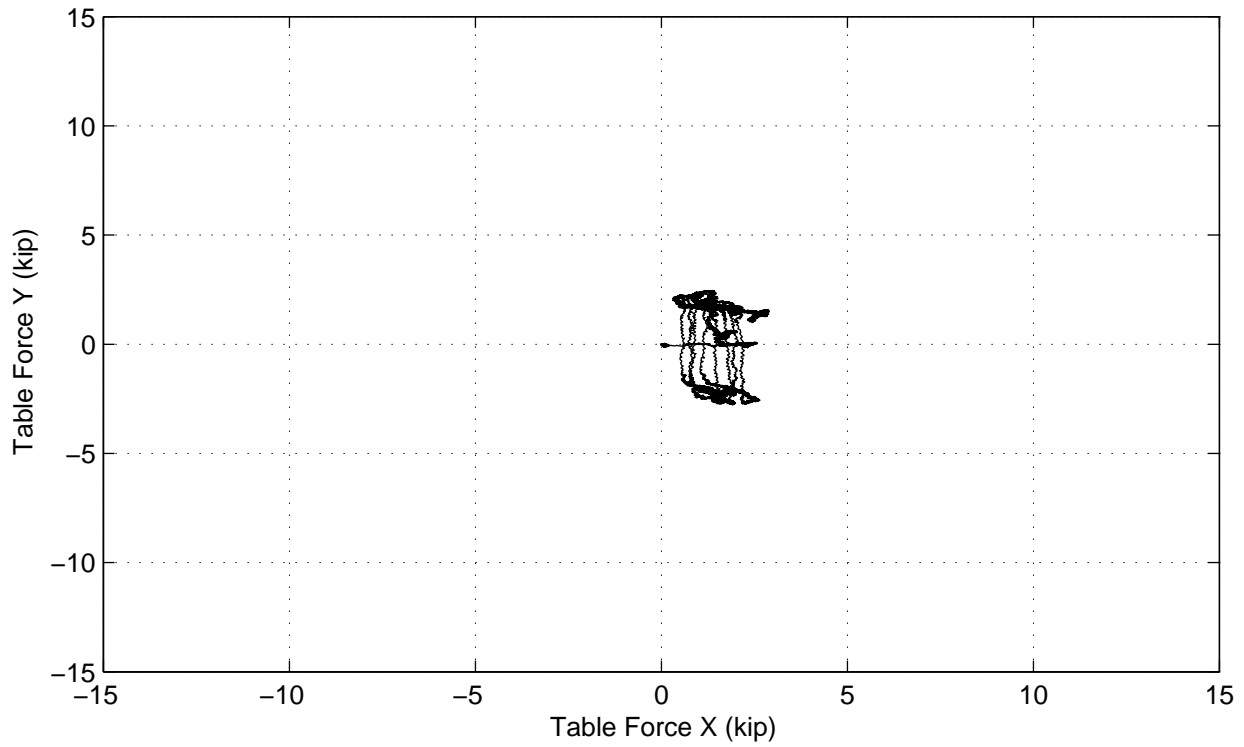
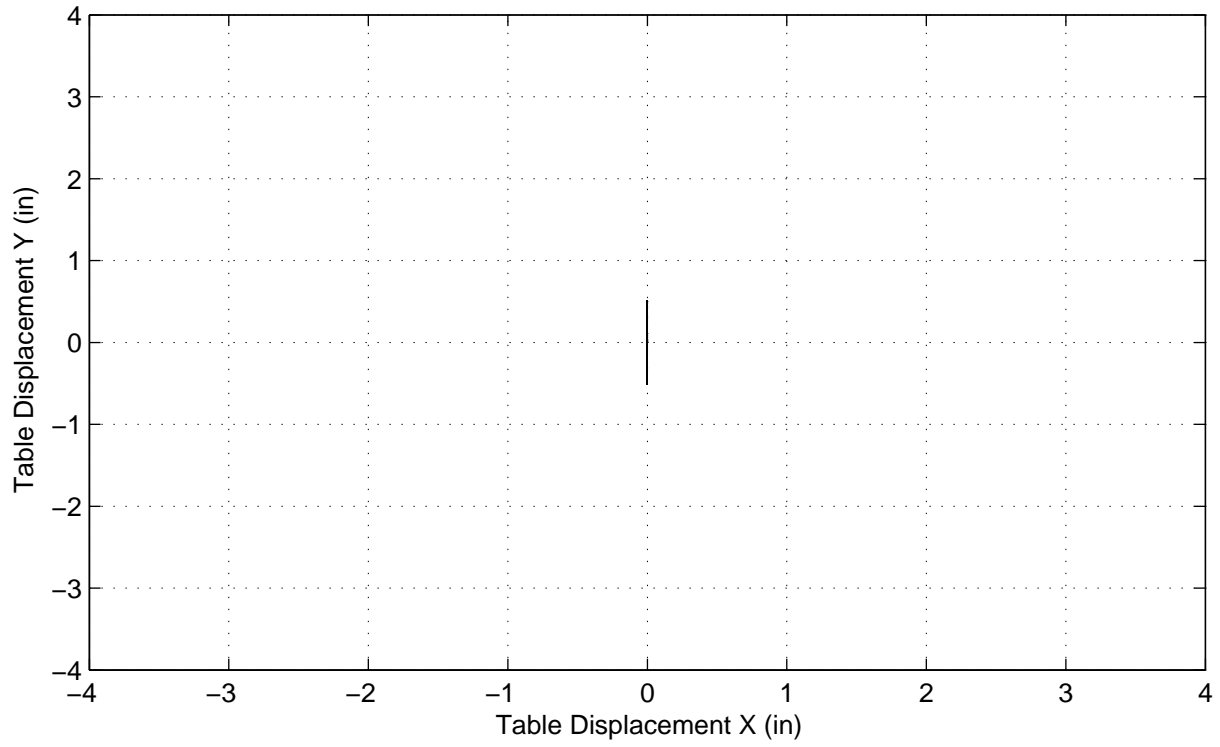

AP4 (Added Mass) – Test C, 0.5in. Quasi-static Y Disp

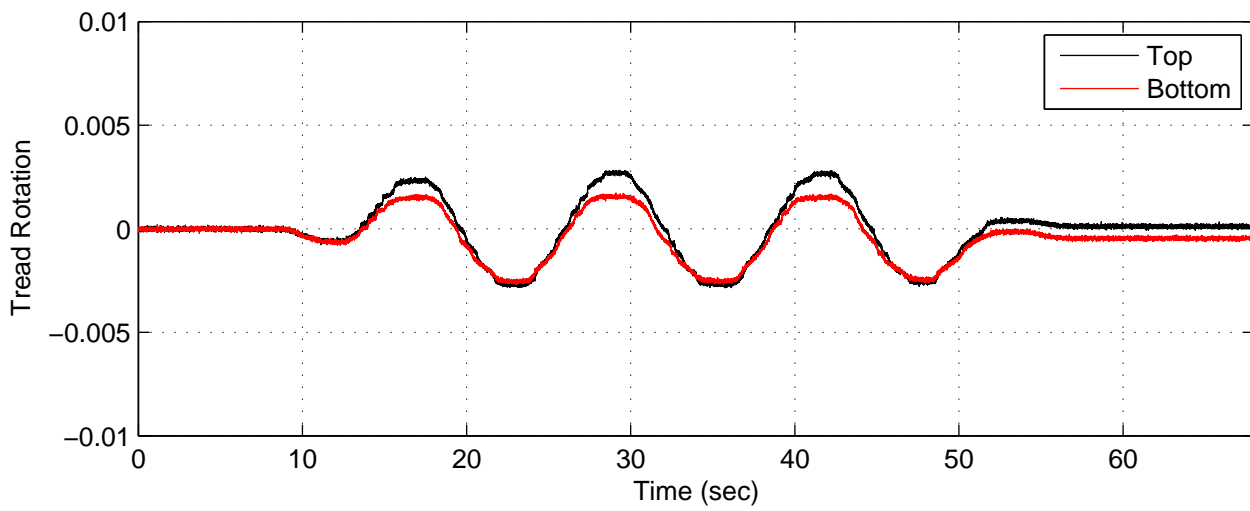
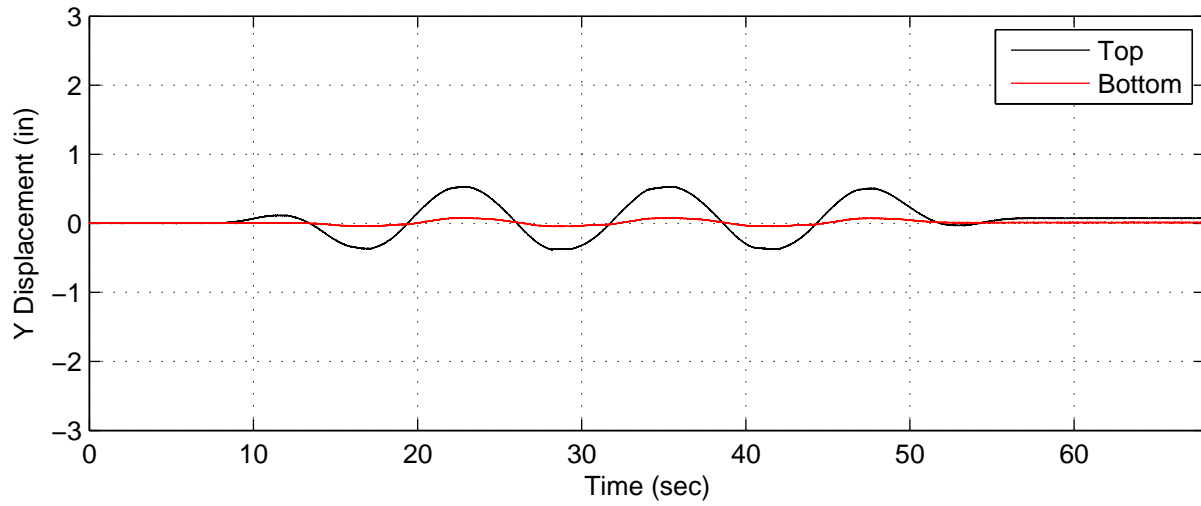
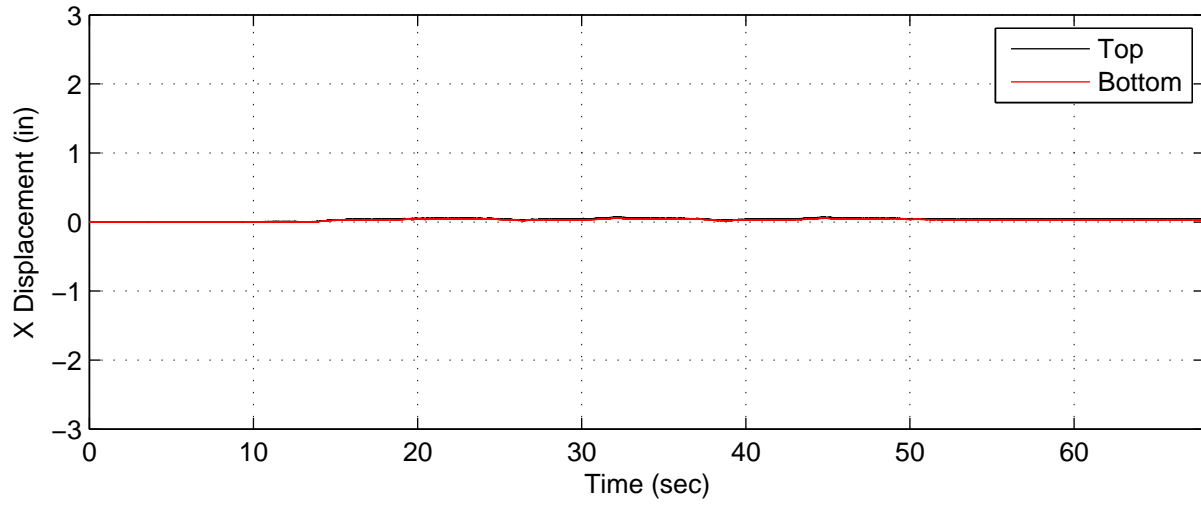

AP4 (Added Mass) – Test C, 0.5in. Quasi-static Y Disp

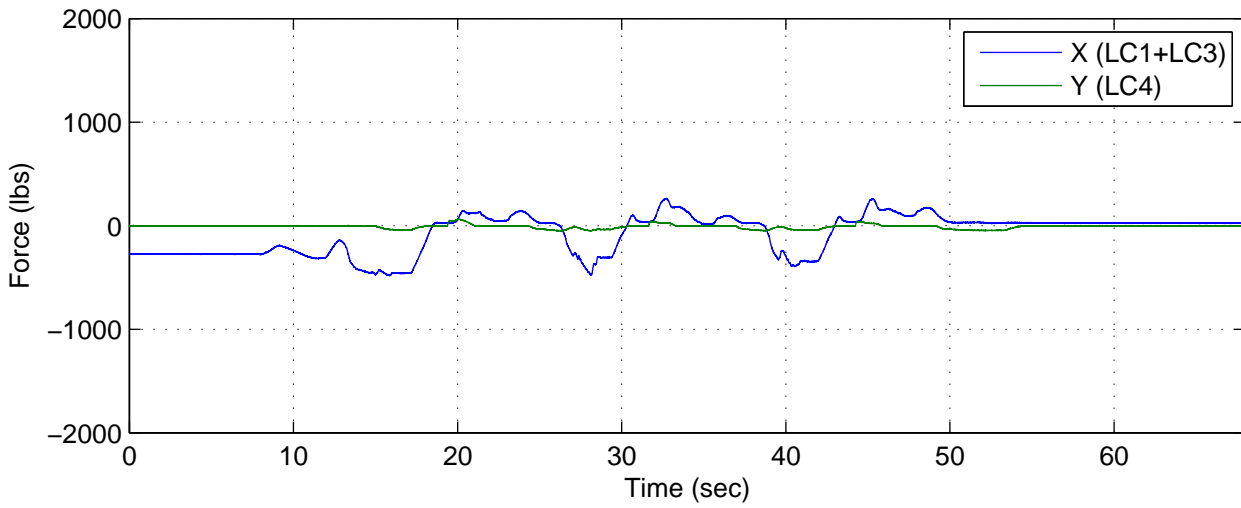
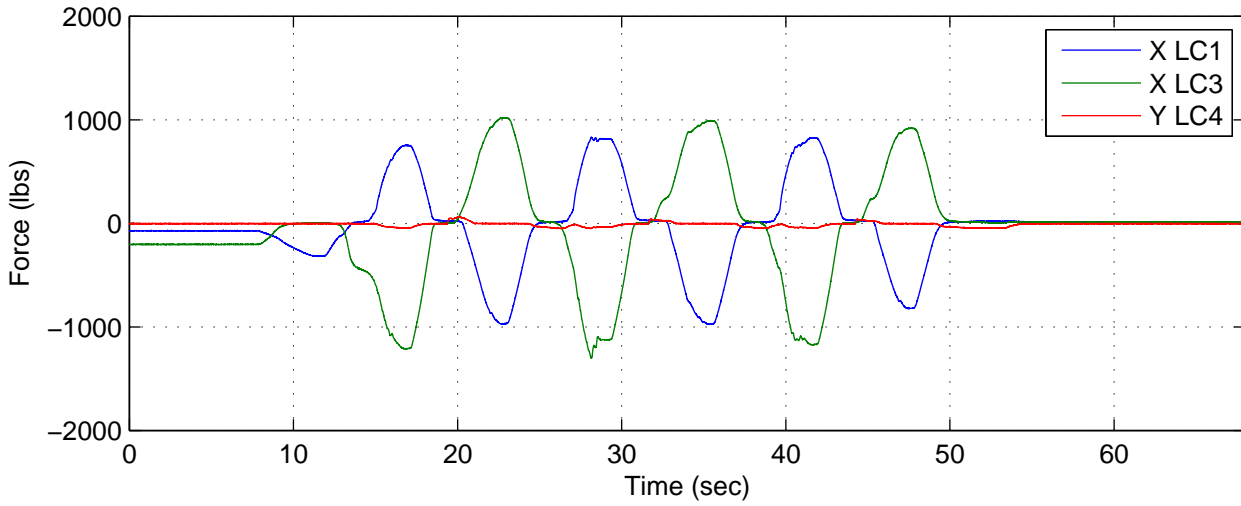
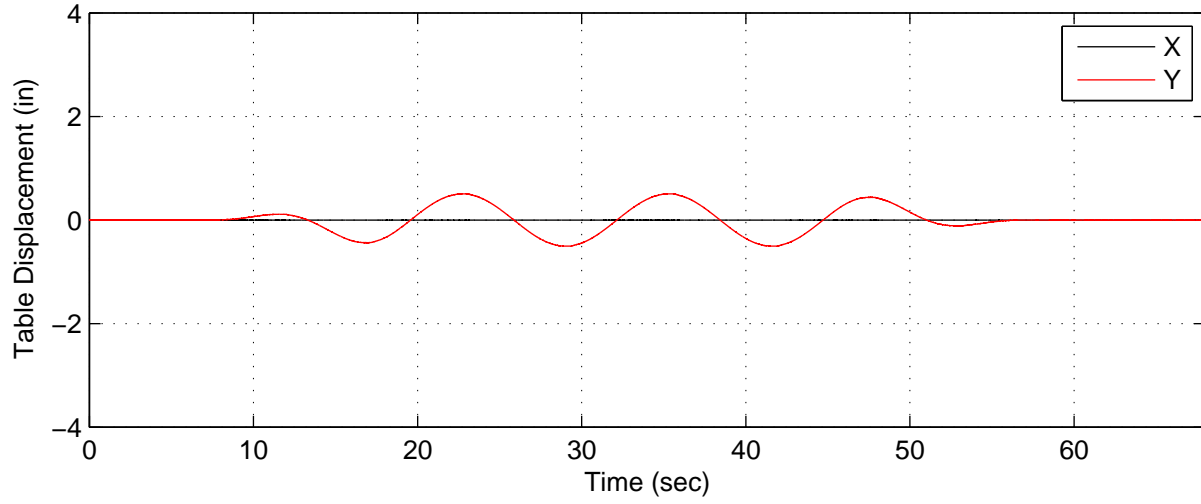

AP4 (Added Mass) – Test C, 0.5in. Quasi-static Y Disp

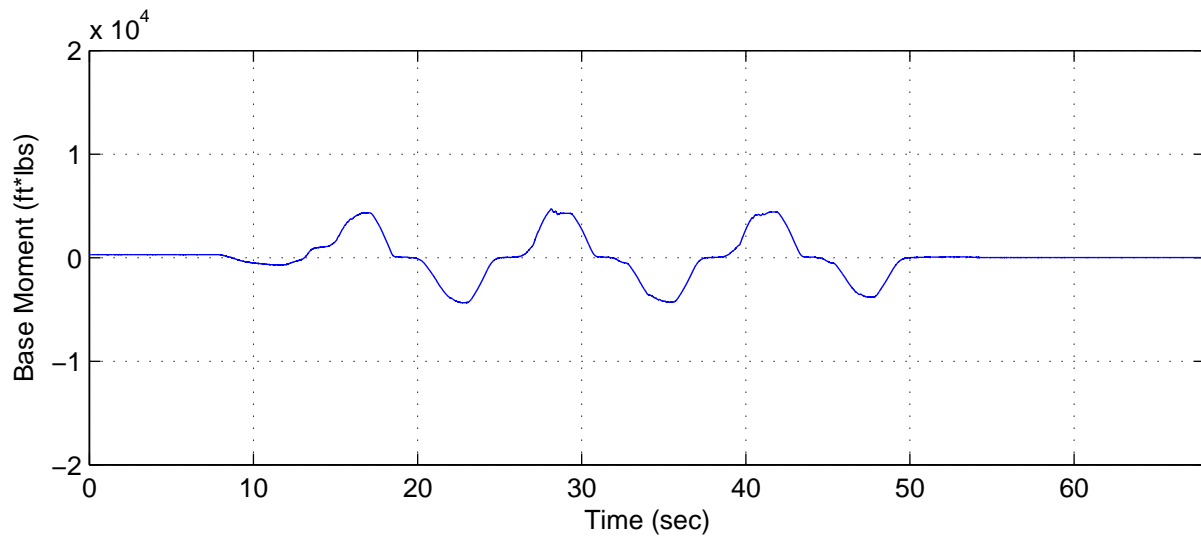
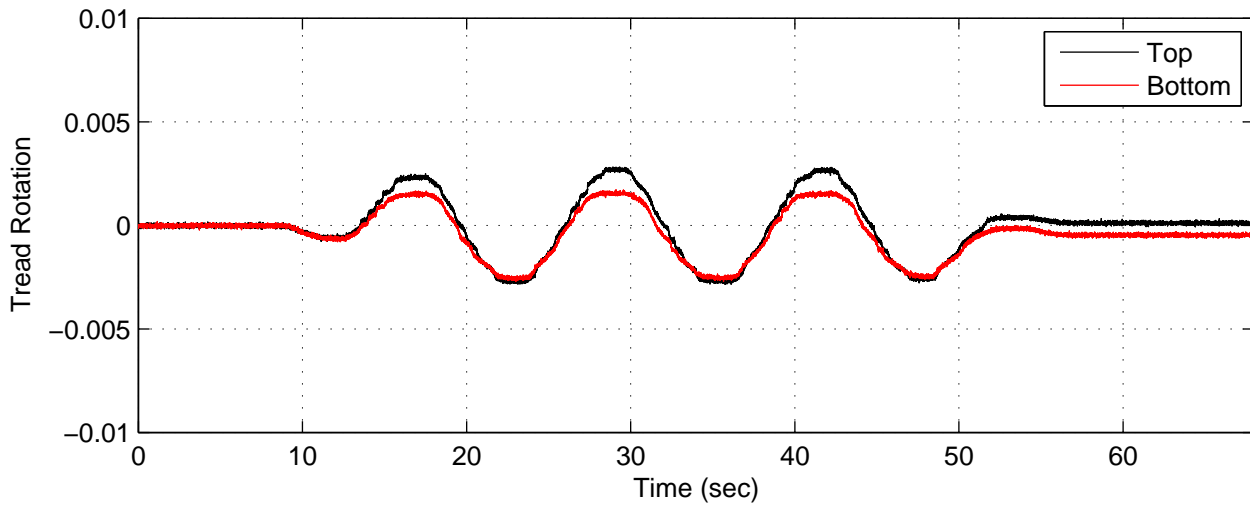
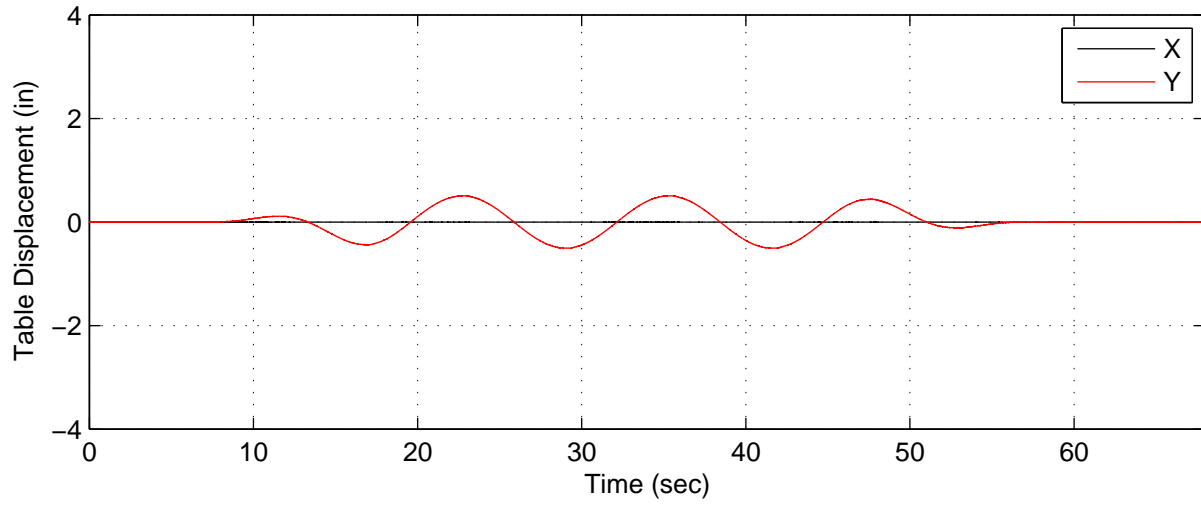



AP4 (Added Mass) – Test D, 2.5in. Quasi-static Y Disp

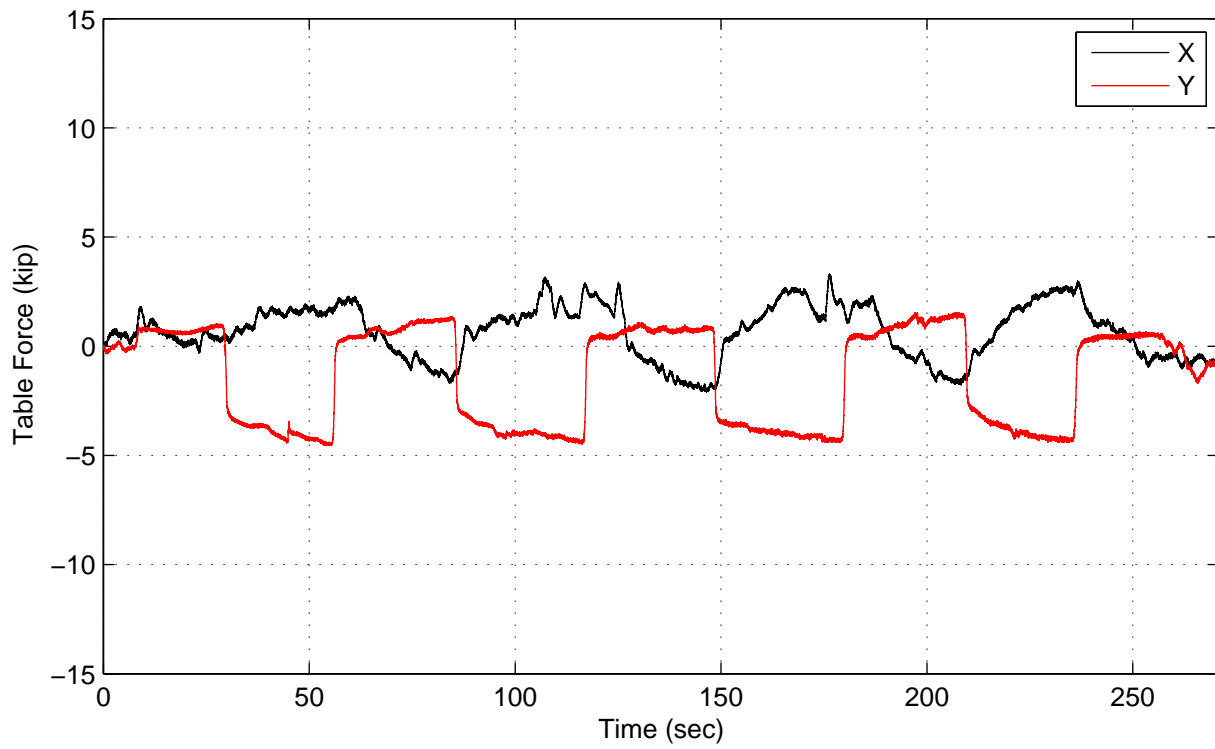
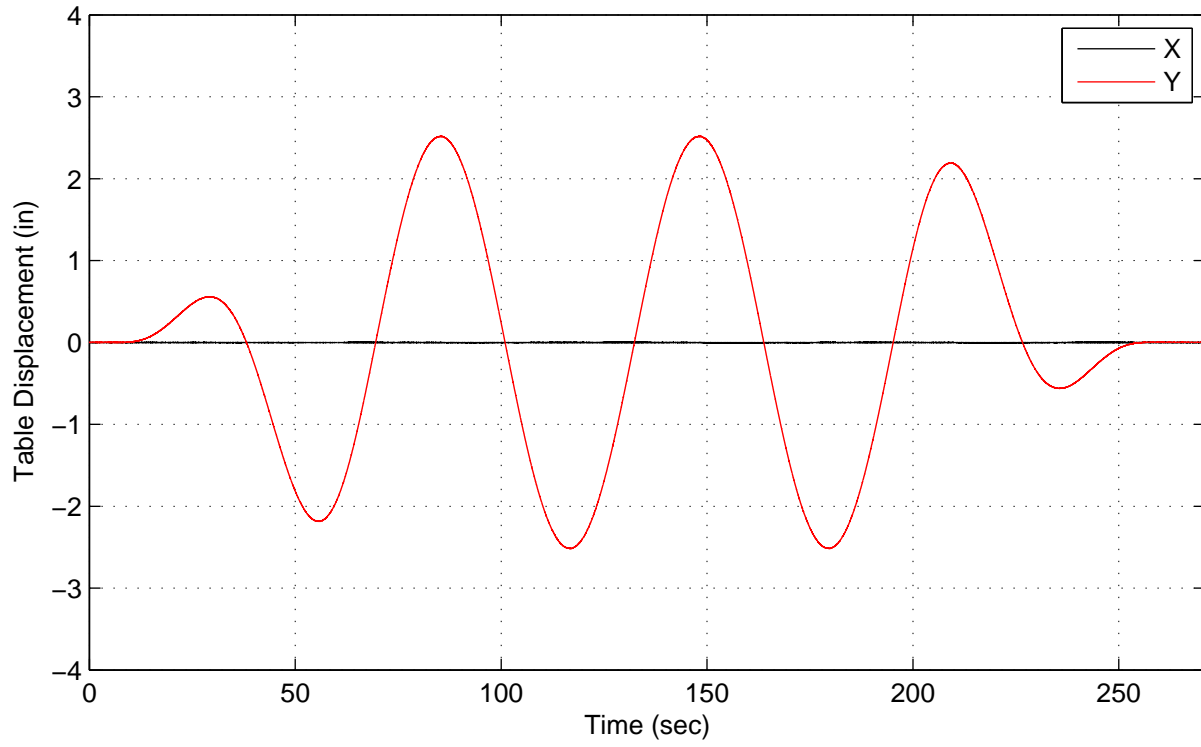

AP4 (Added Mass) – Test D, 2.5in. Quasi-static Y Disp

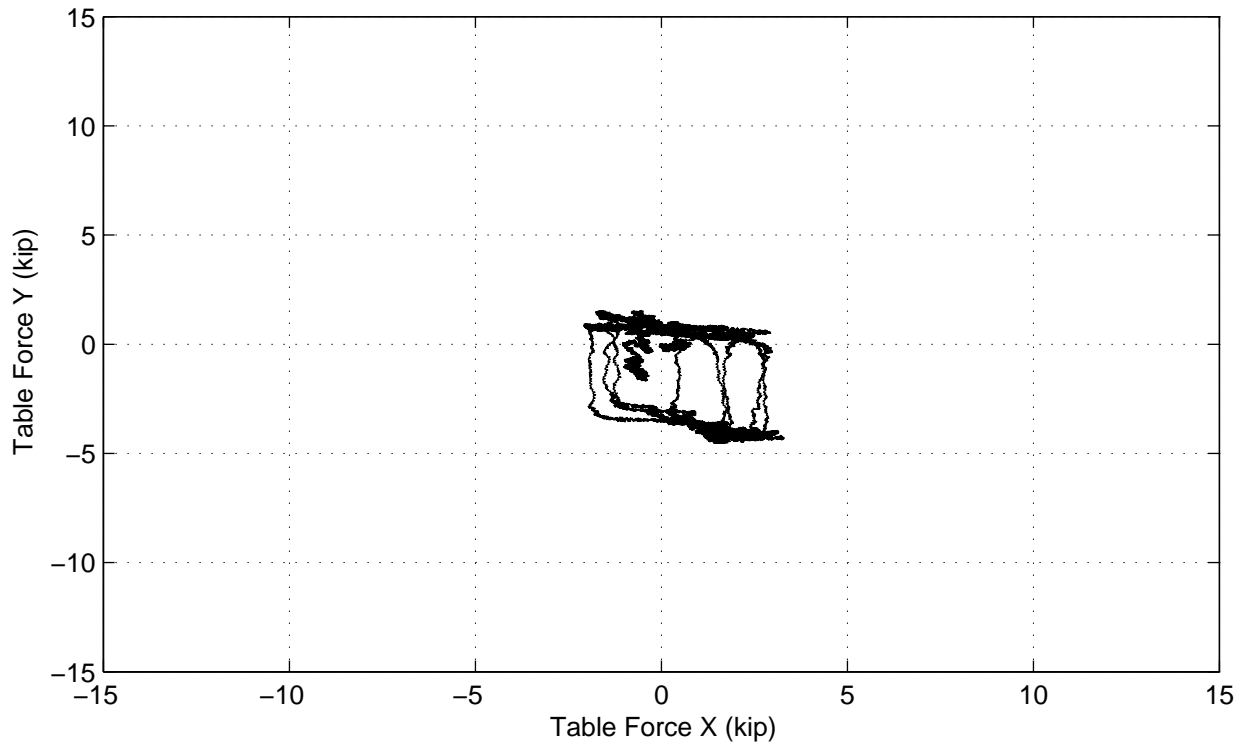
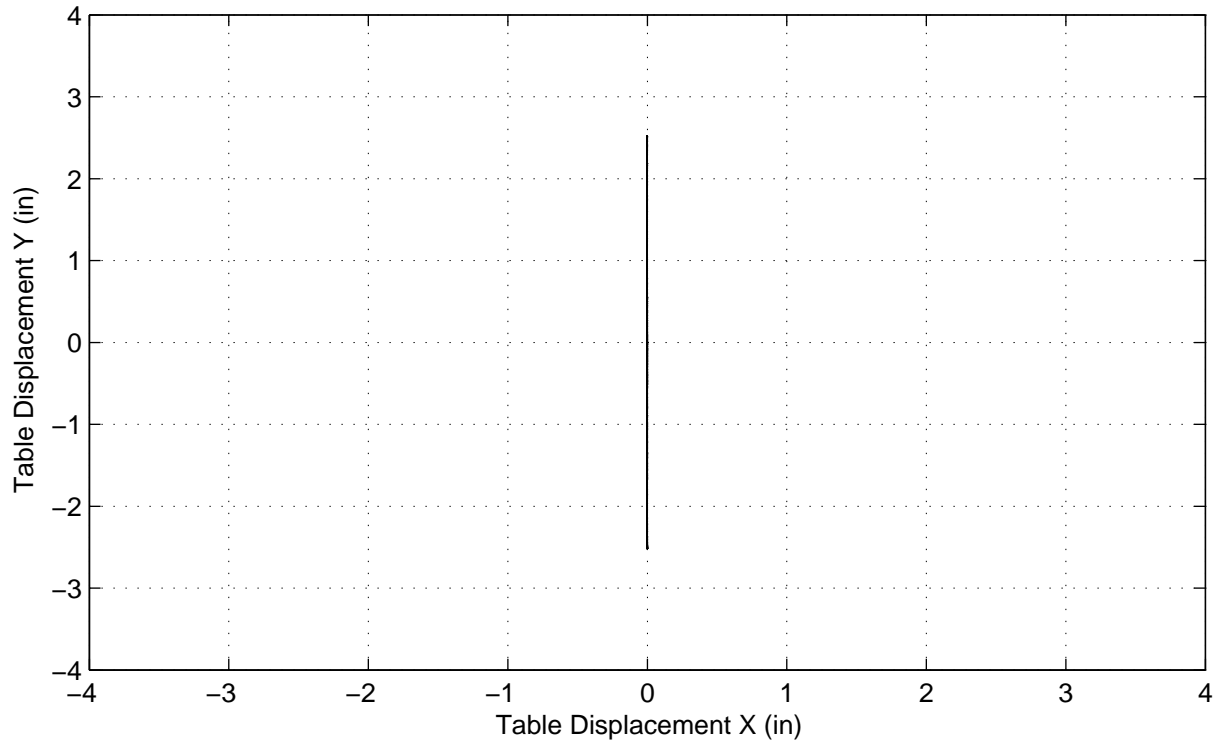

AP4 (Added Mass) – Test D, 2.5in. Quasi-static Y Disp

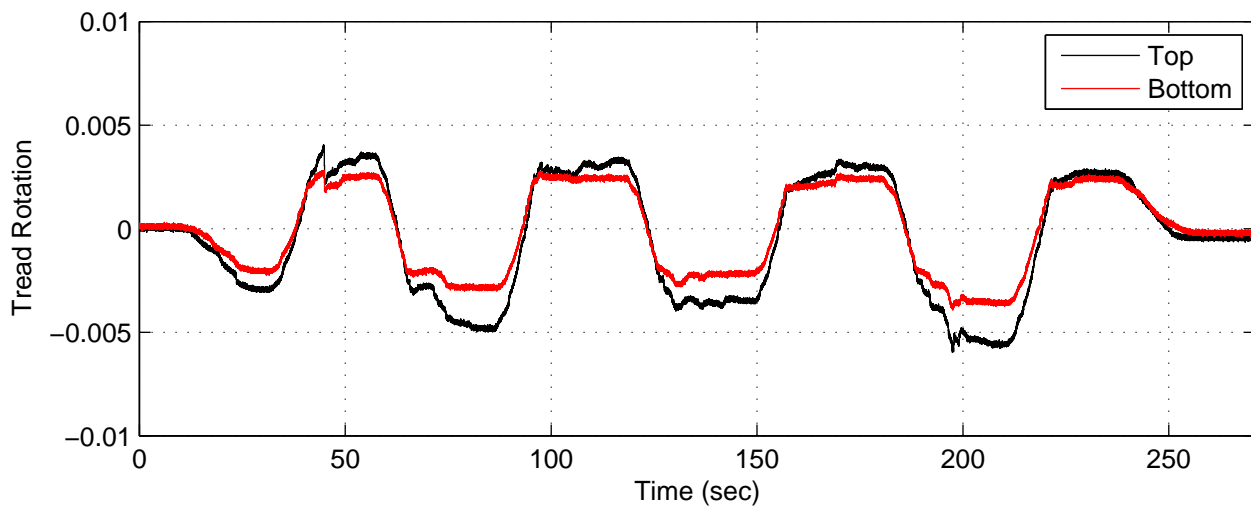
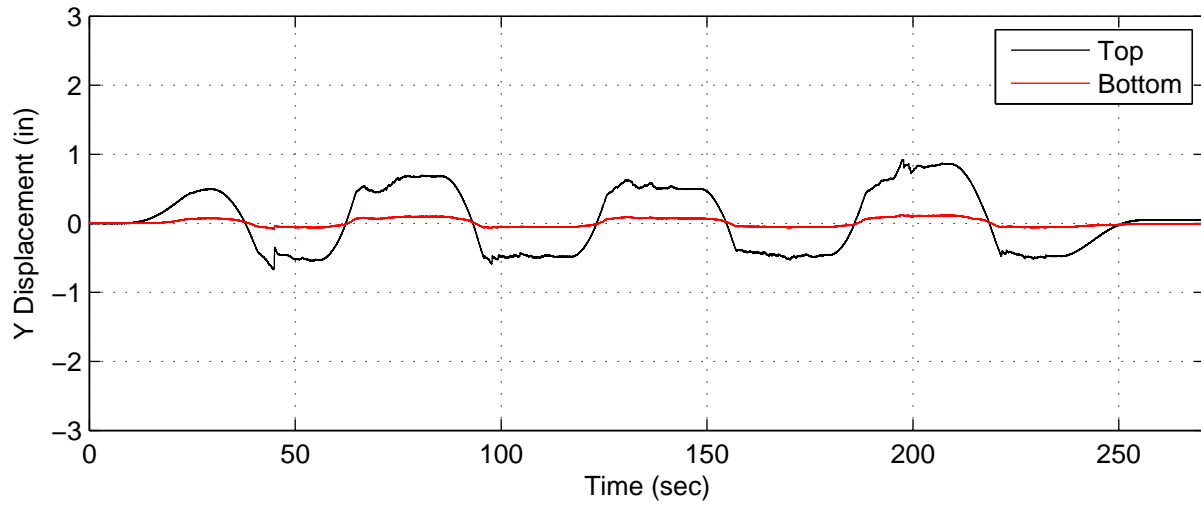
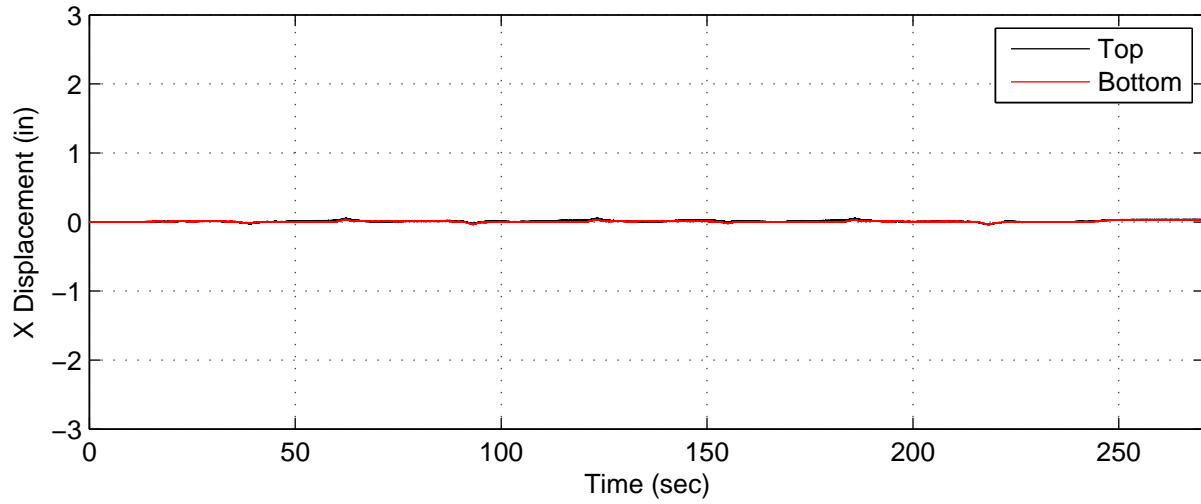

AP4 (Added Mass) – Test D, 2.5in. Quasi-static Y Disp

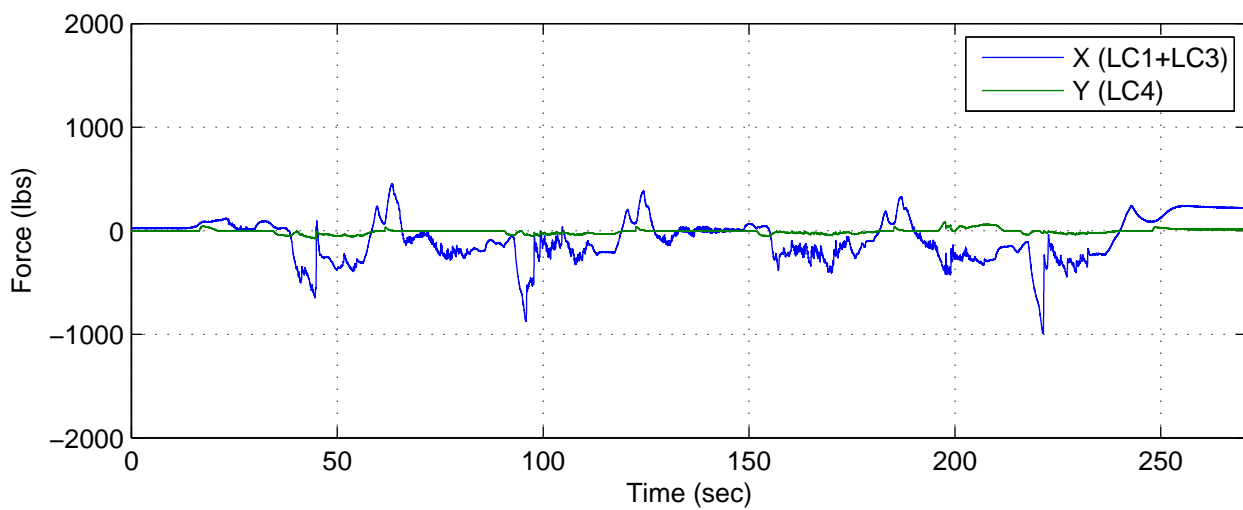
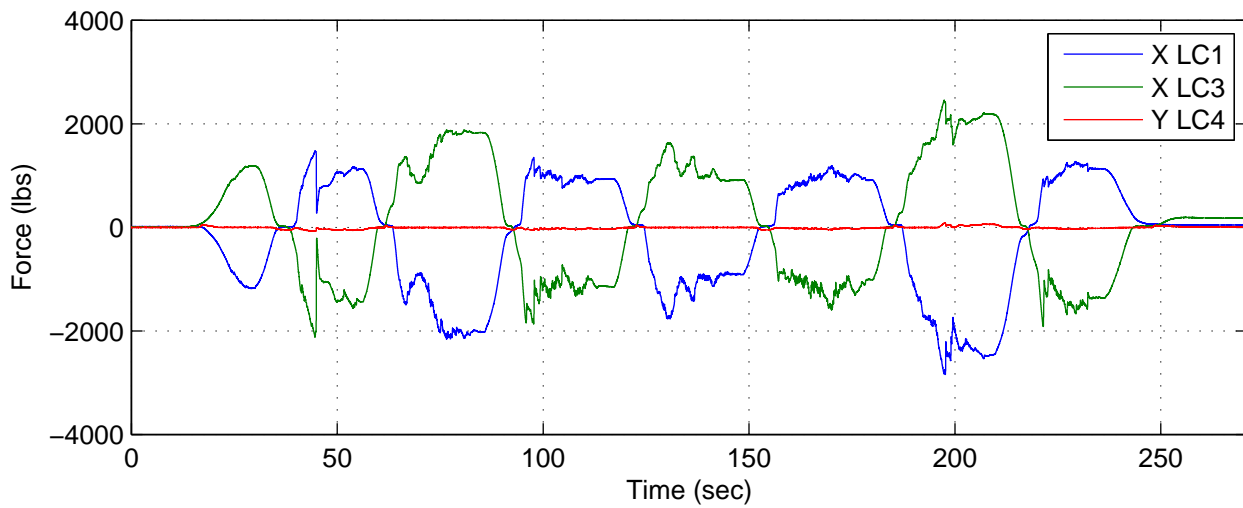
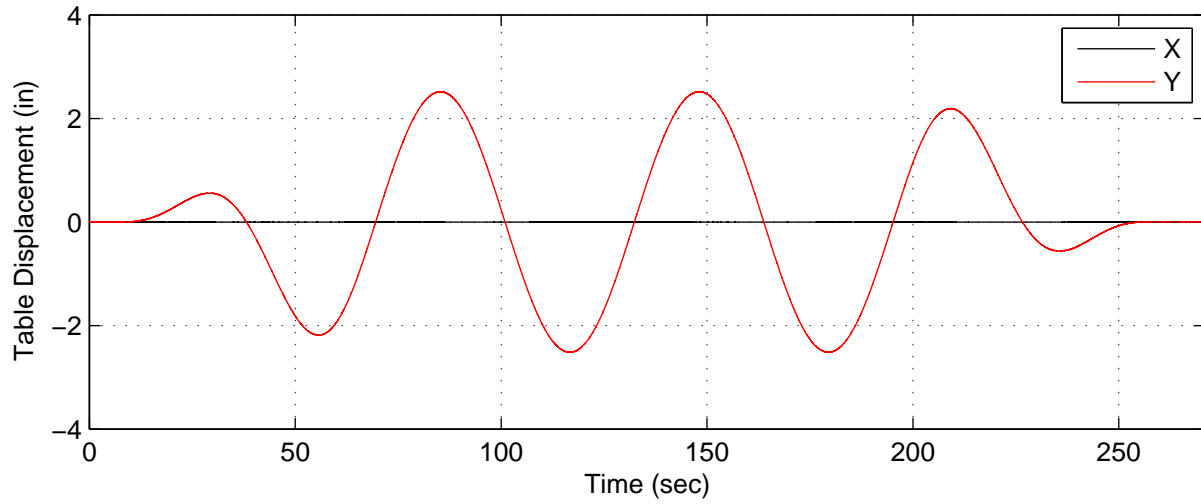

AP4 (Added Mass) – Test D, 2.5in. Quasi-static Y Disp

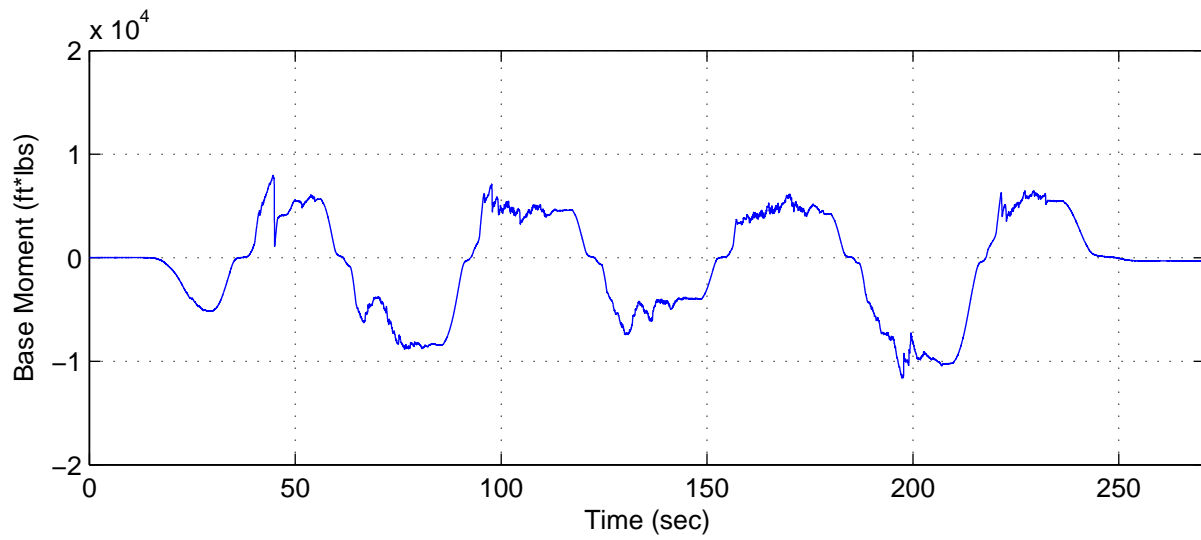
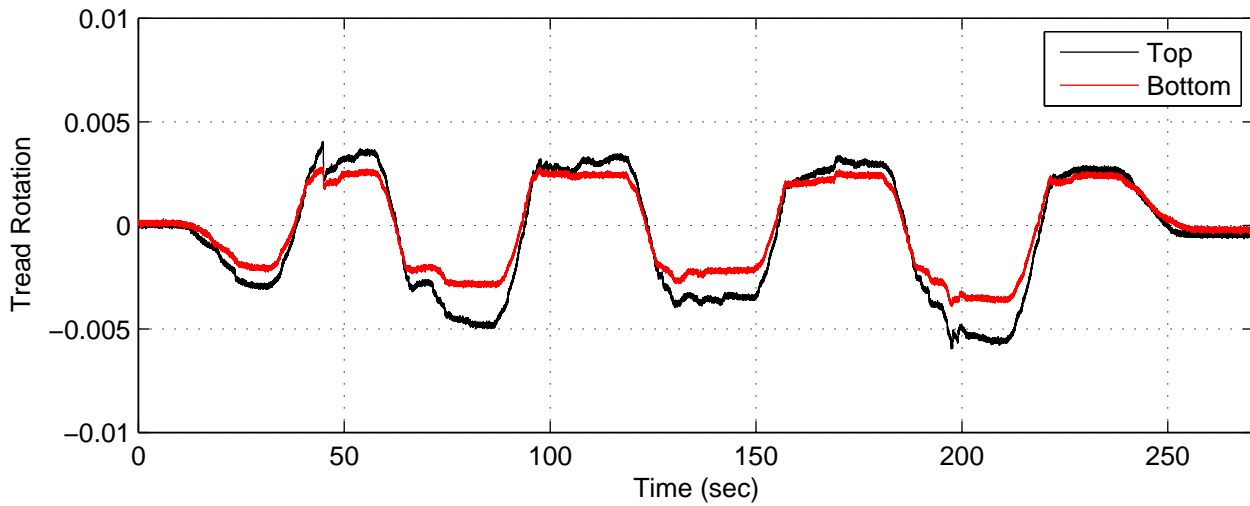
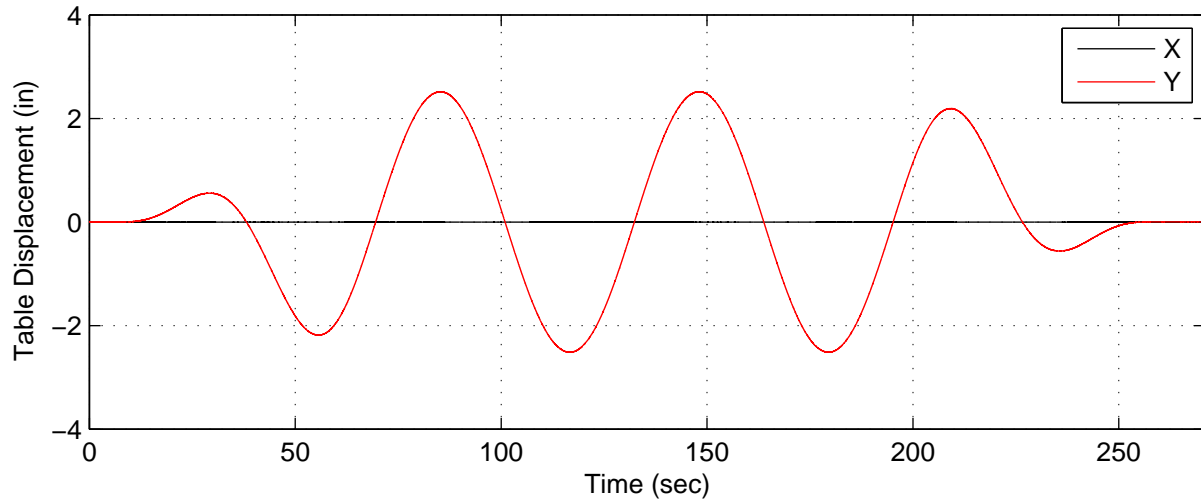

AP4 (Added Mass) – Test E, 0.5in. Dynamic X Disp

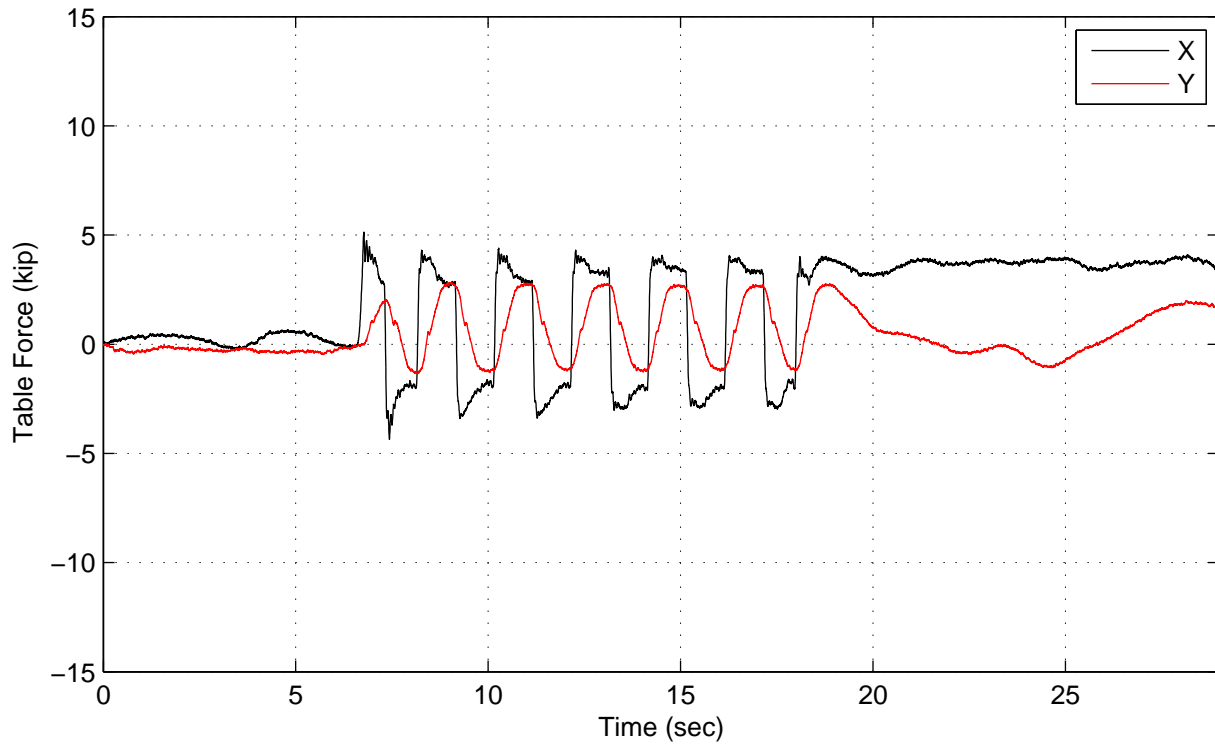
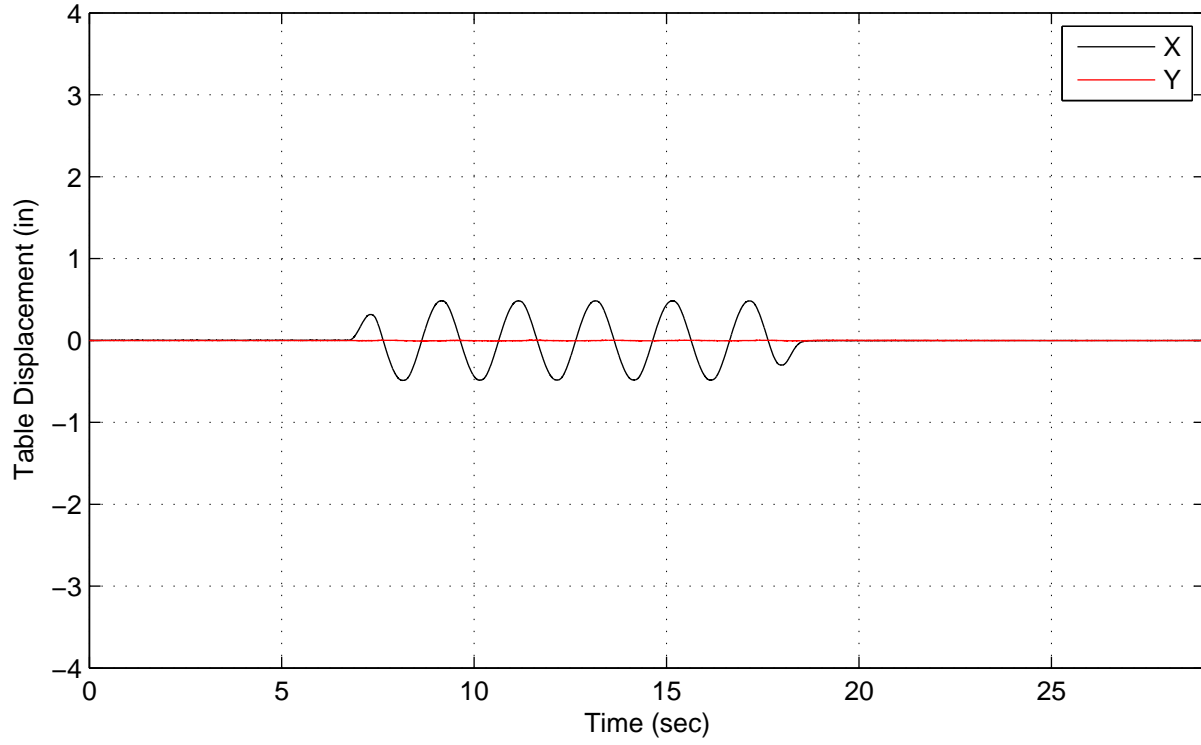

AP4 (Added Mass) – Test E, 0.5in. Dynamic X Disp

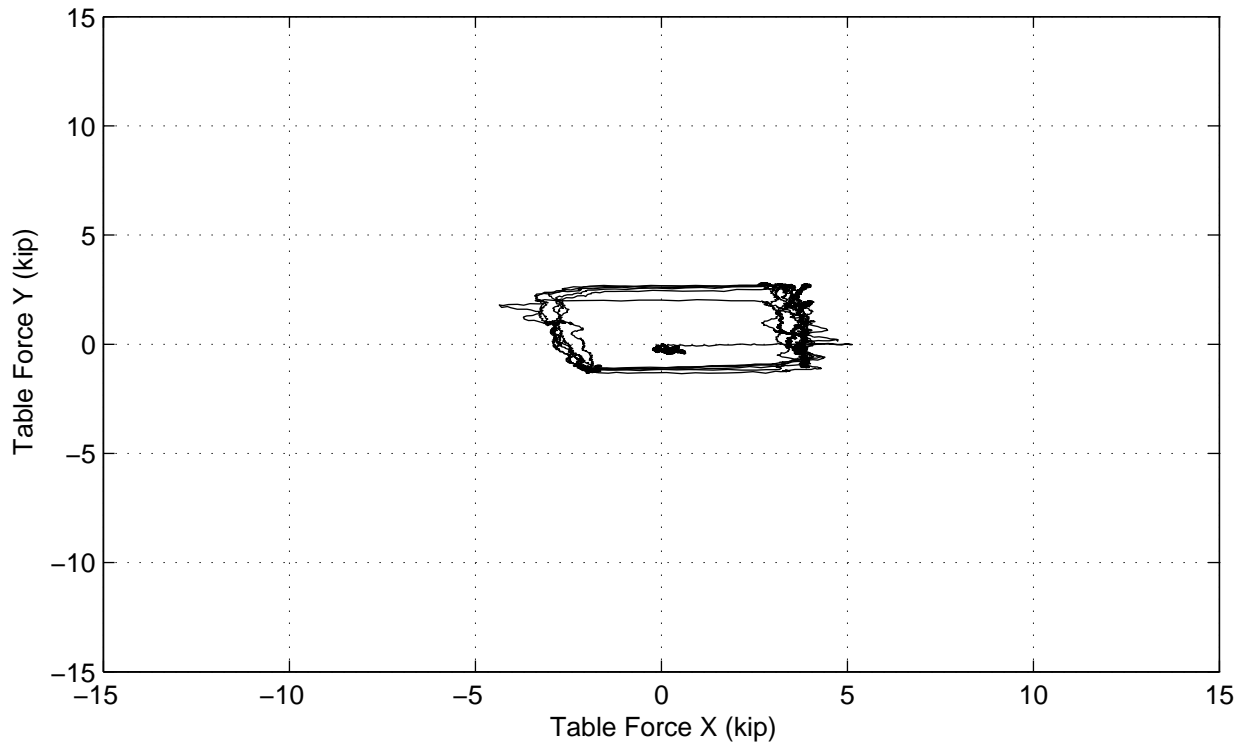
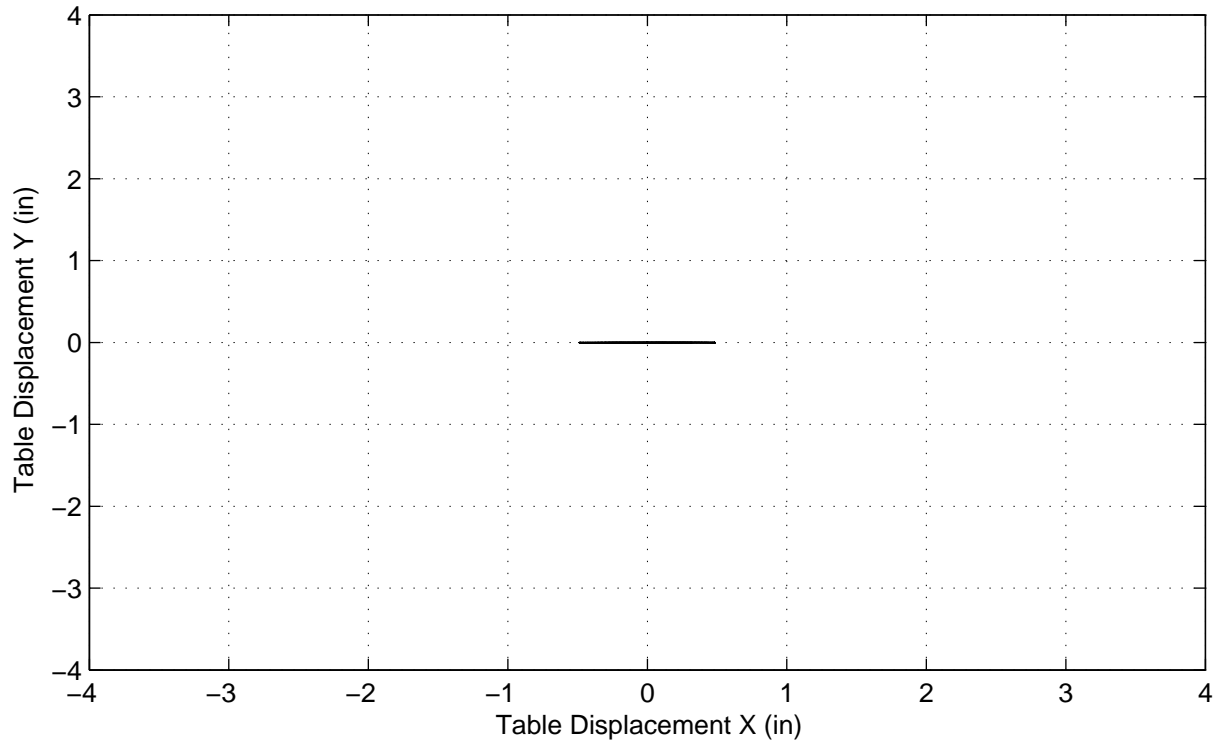

AP4 (Added Mass) – Test E, 0.5in. Dynamic X Disp

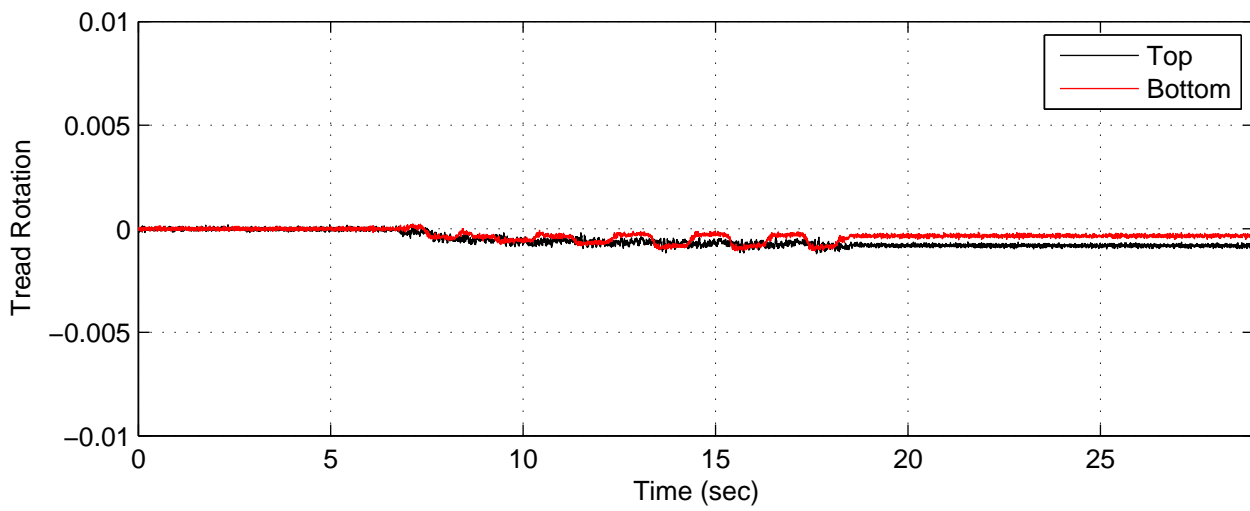
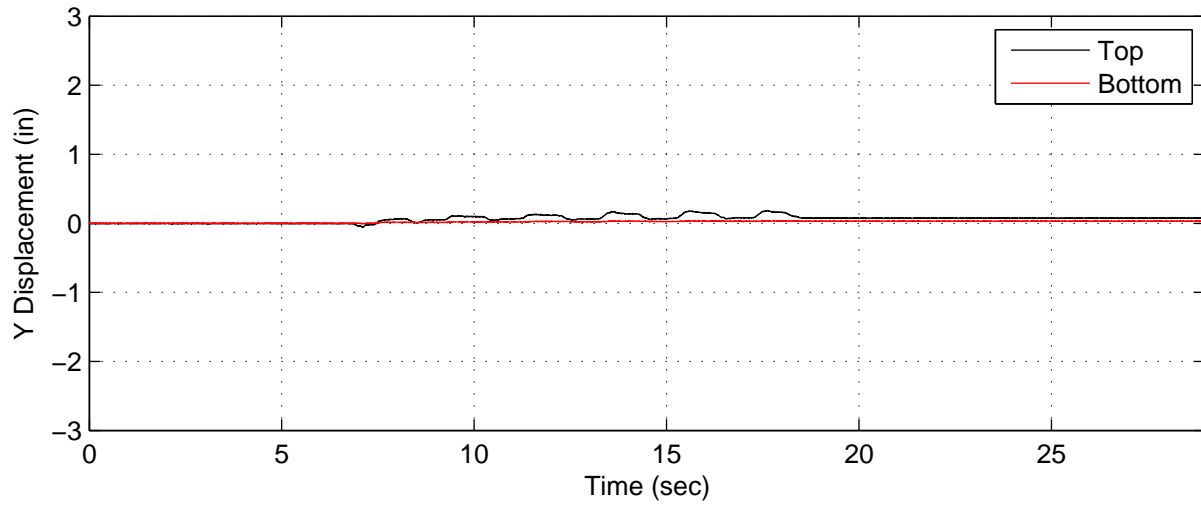
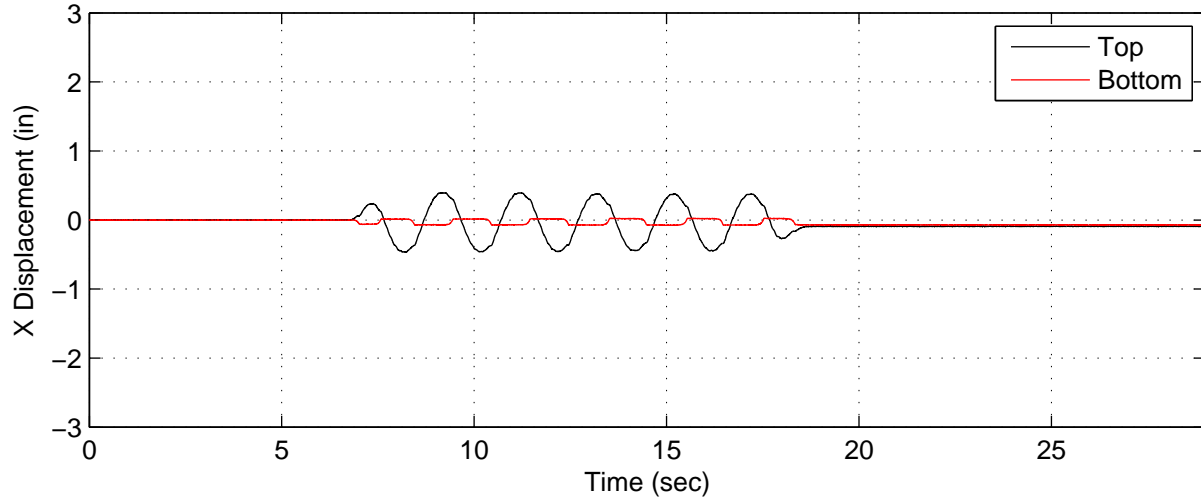



AP4 (Added Mass) – Test E, 0.5in. Dynamic X Disp

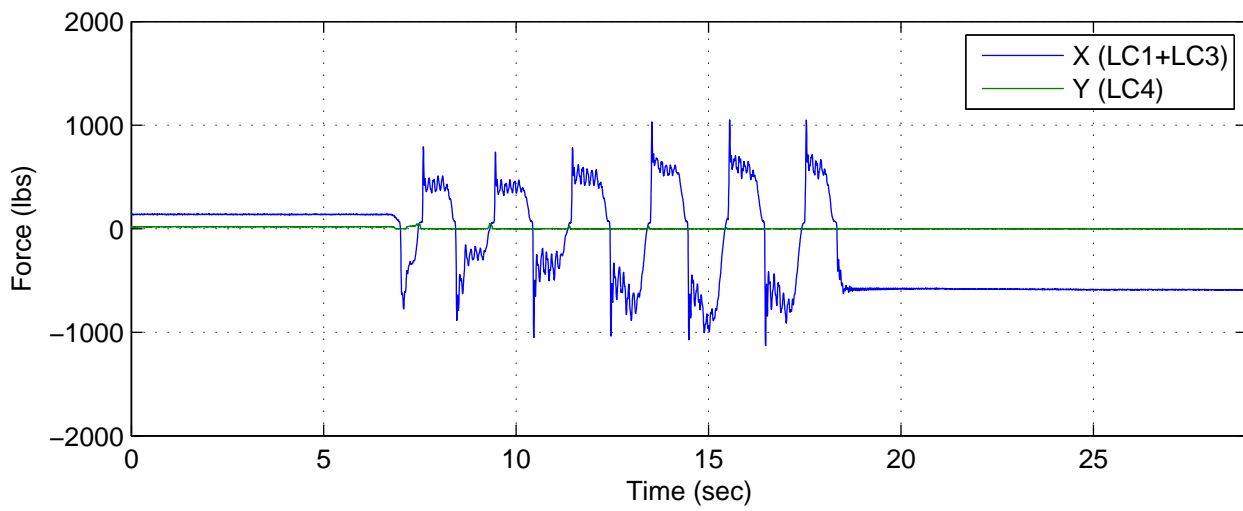
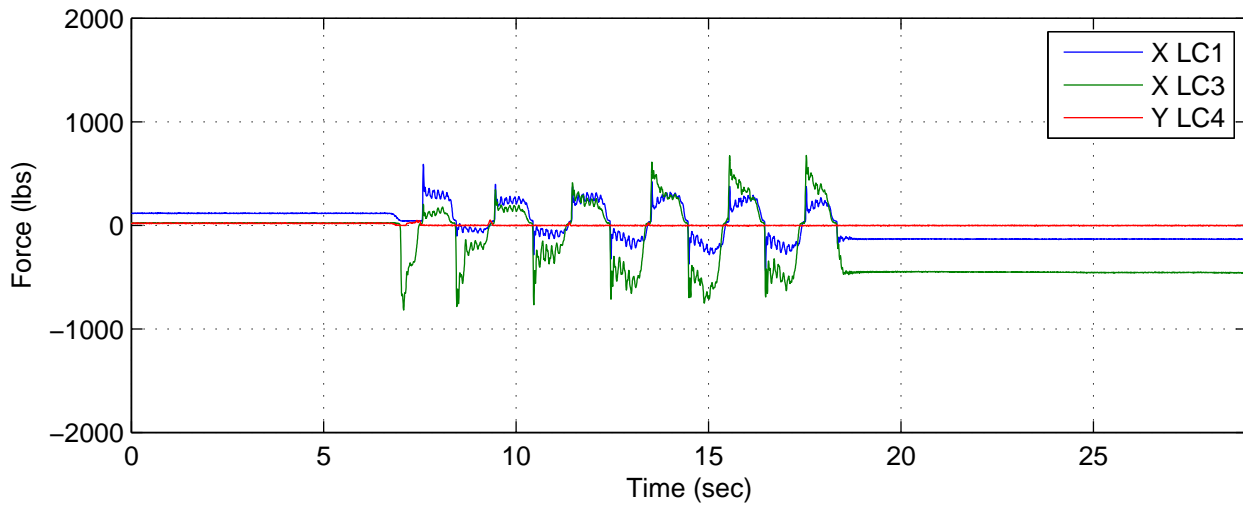
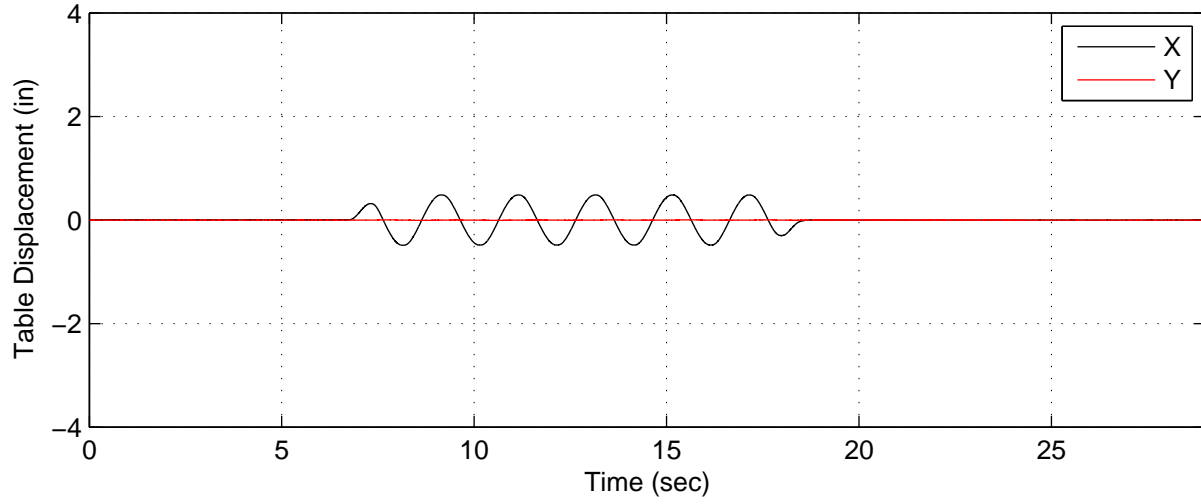

AP4 (Added Mass) – Test E, 0.5in. Dynamic X Disp

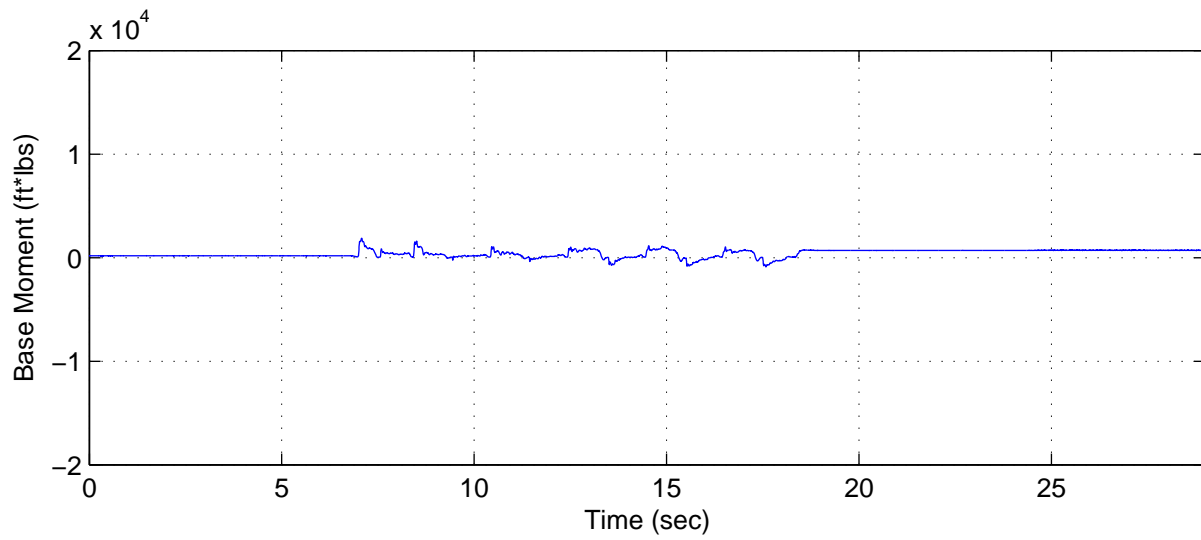
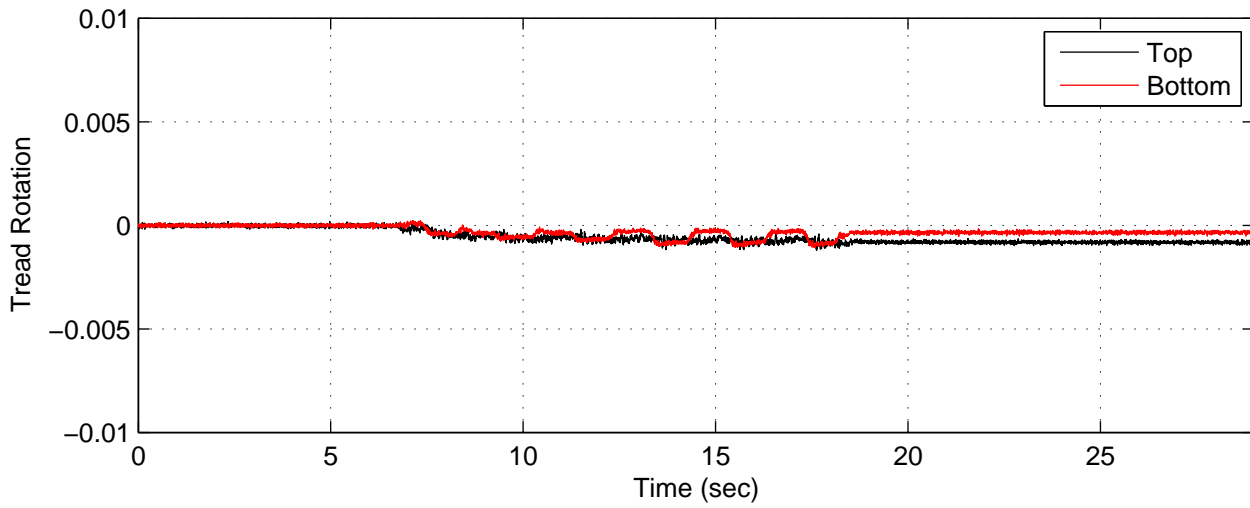
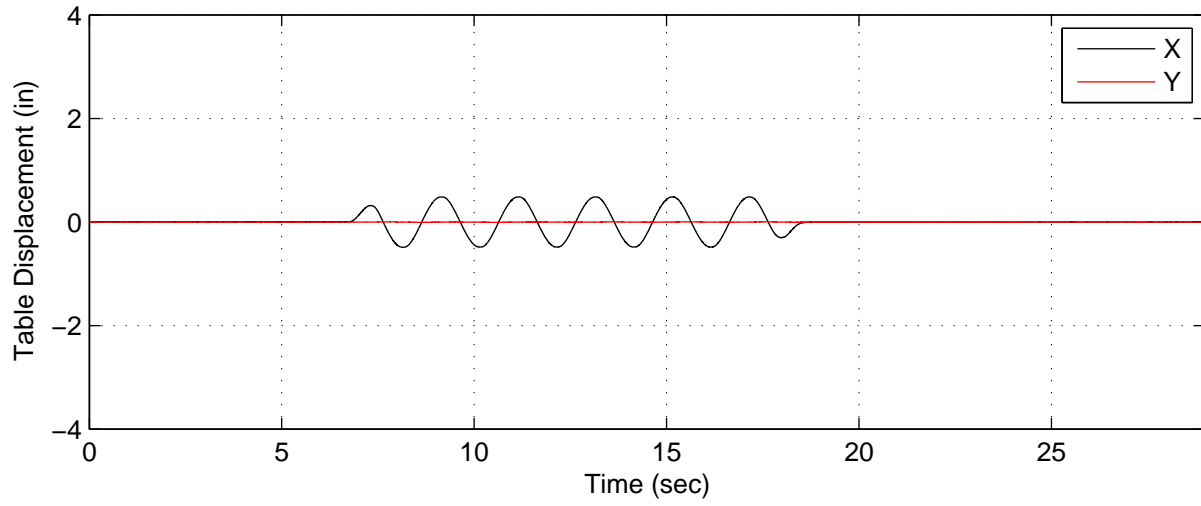

AP4 (Added Mass) – Test F, 2.5in. Dynamic X Disp

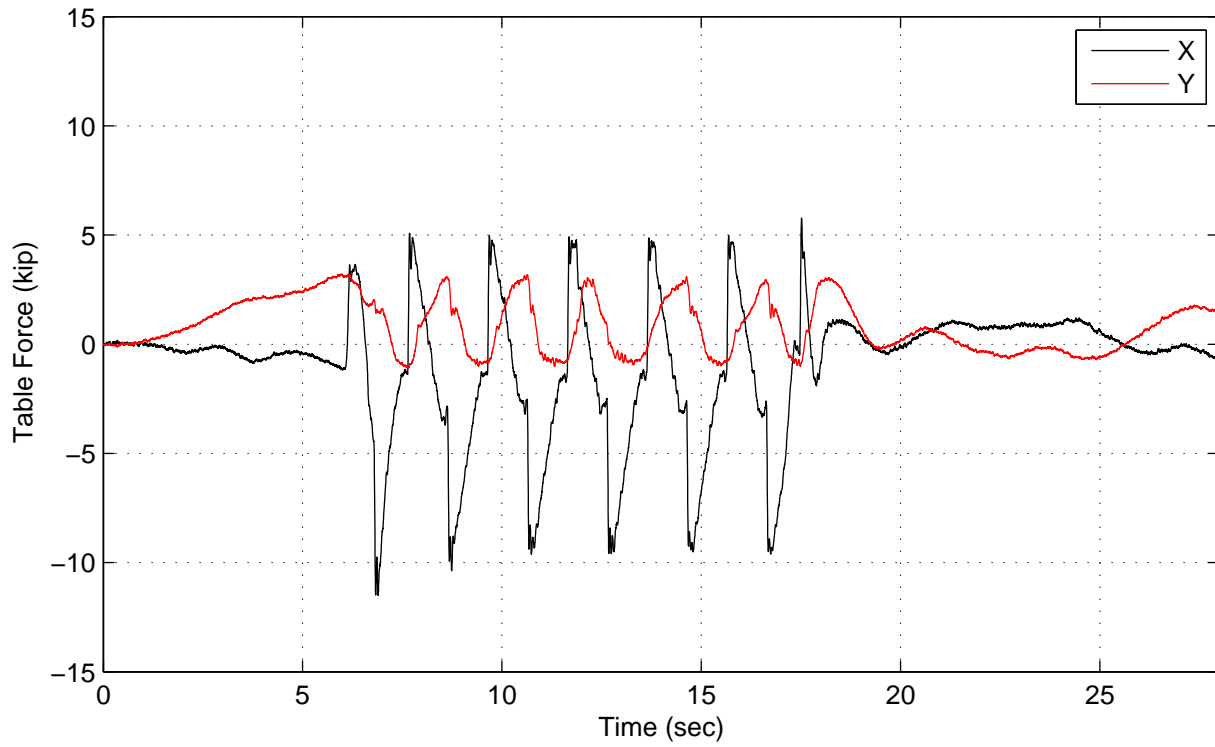
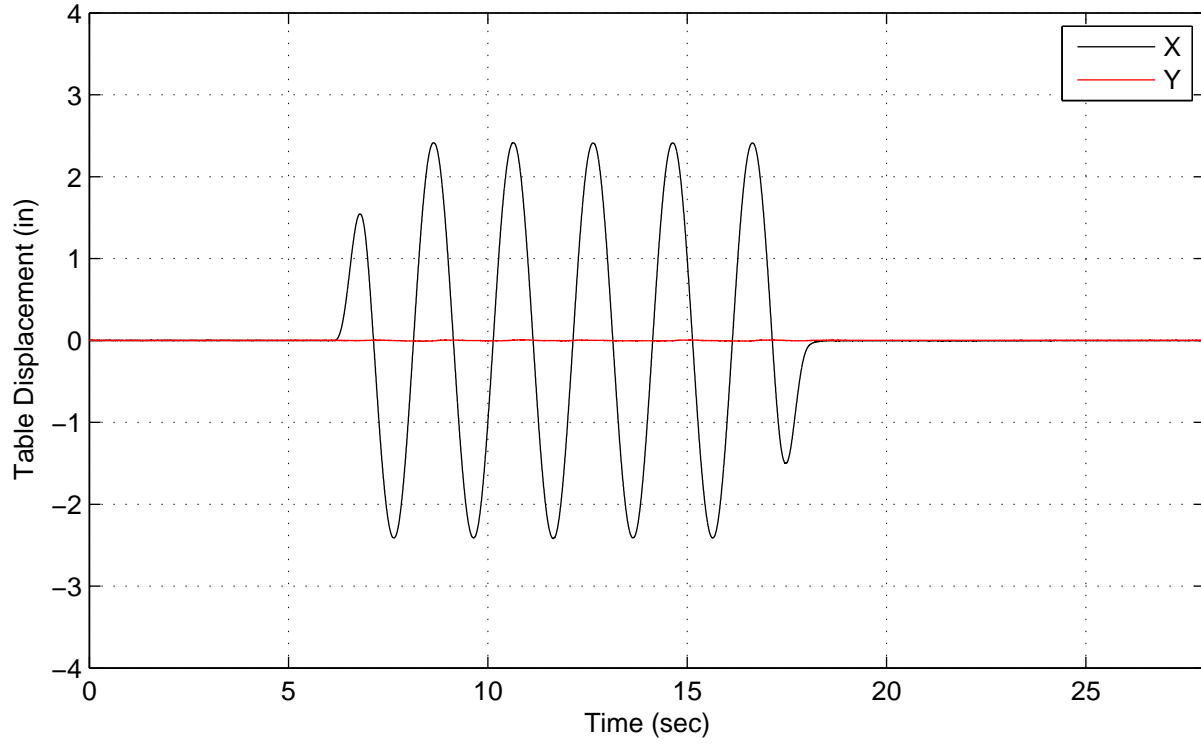

AP4 (Added Mass) – Test F, 2.5in. Dynamic X Disp

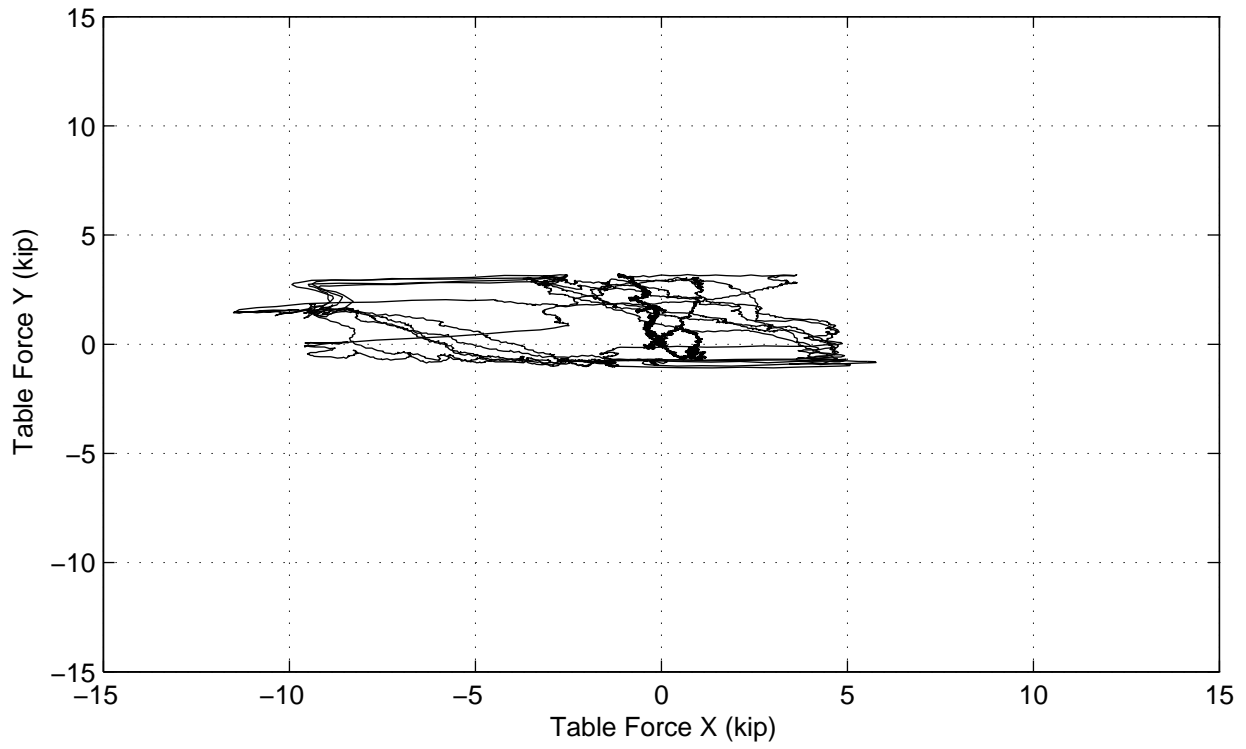
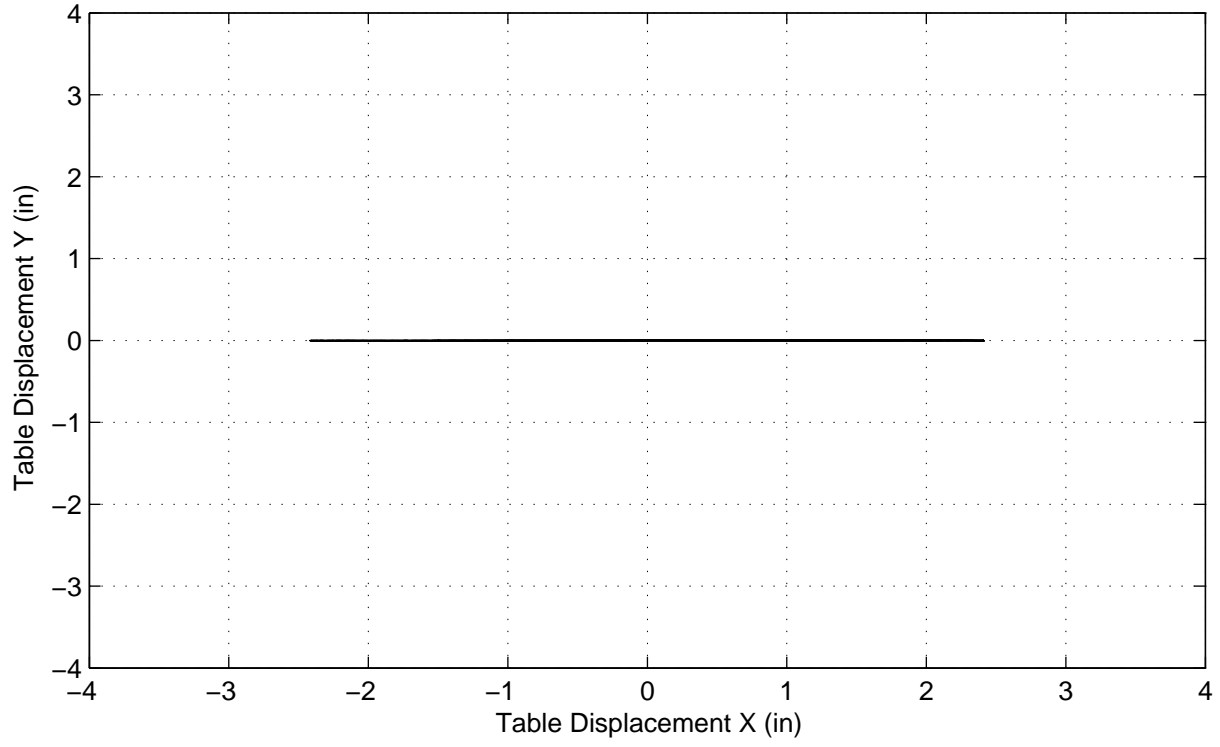

AP4 (Added Mass) – Test F, 2.5in. Dynamic X Disp

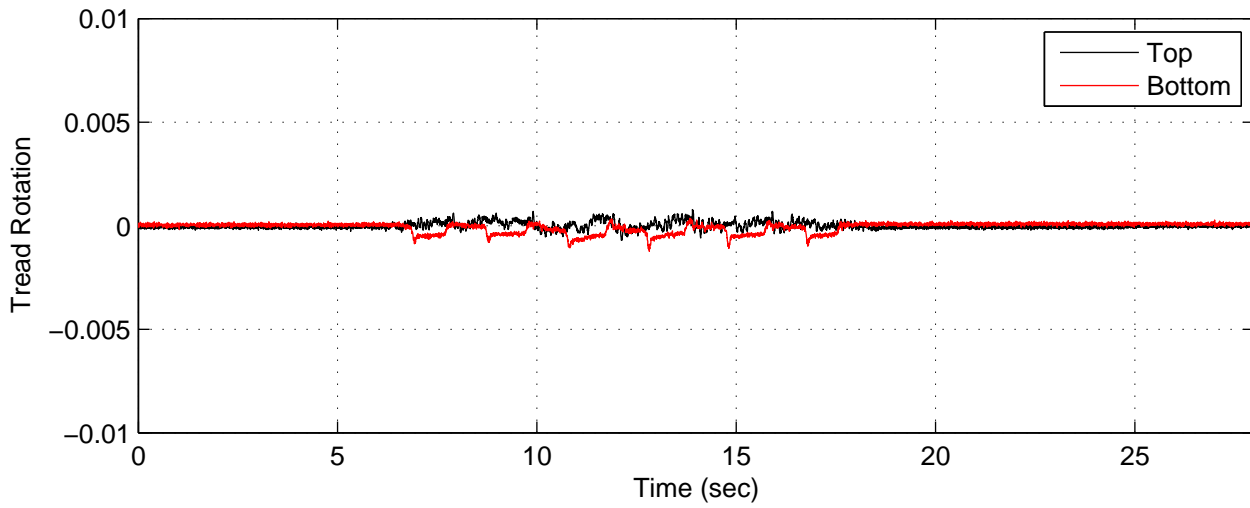
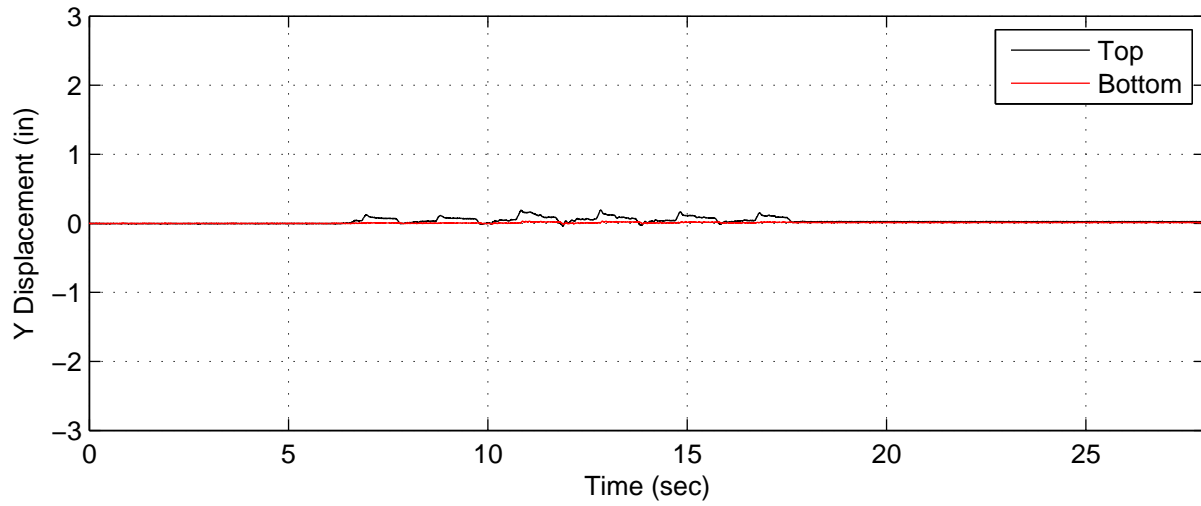
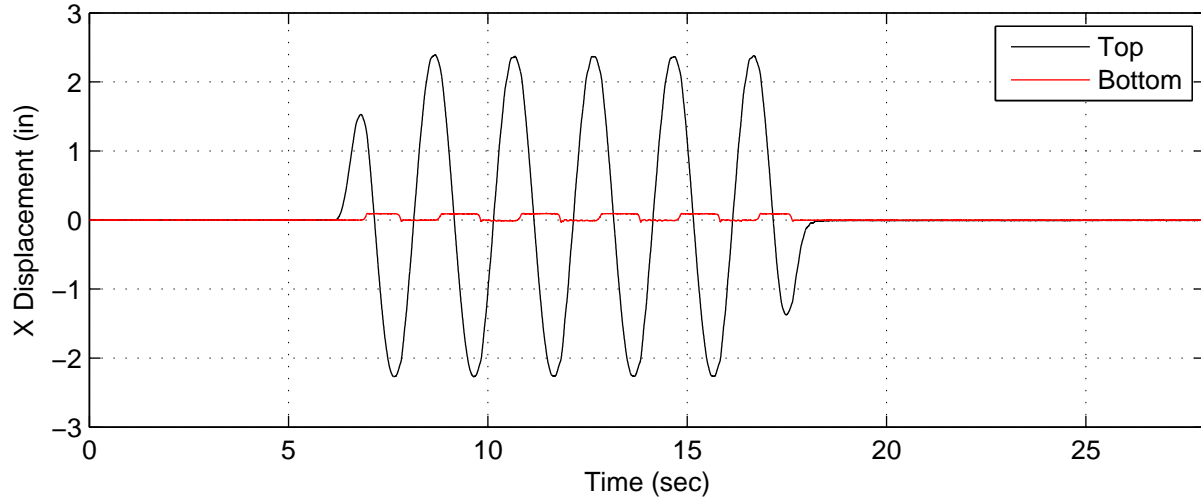

AP4 (Added Mass) – Test F, 2.5in. Dynamic X Disp

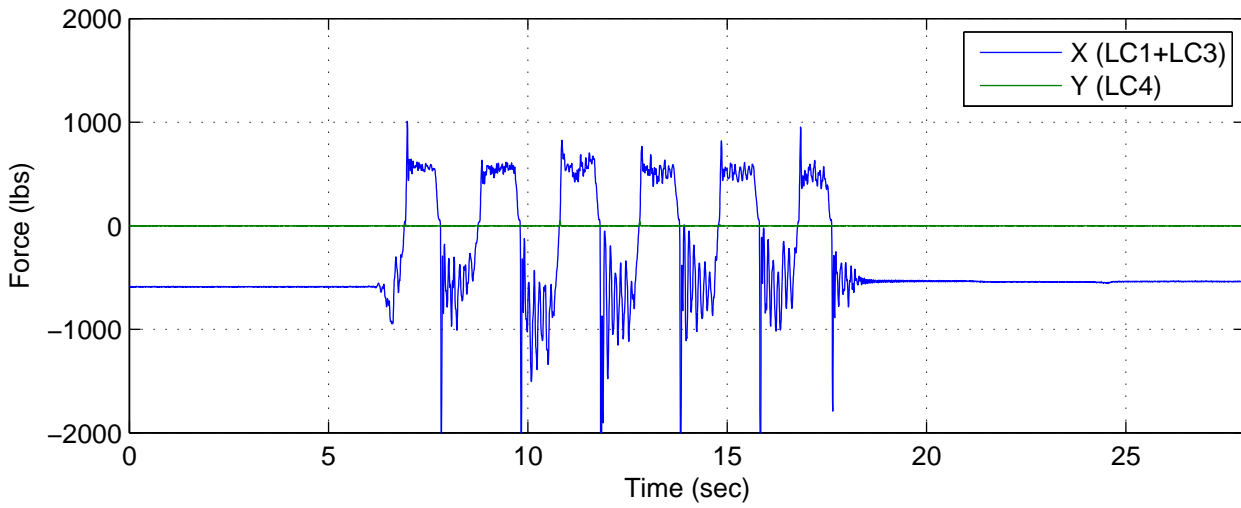
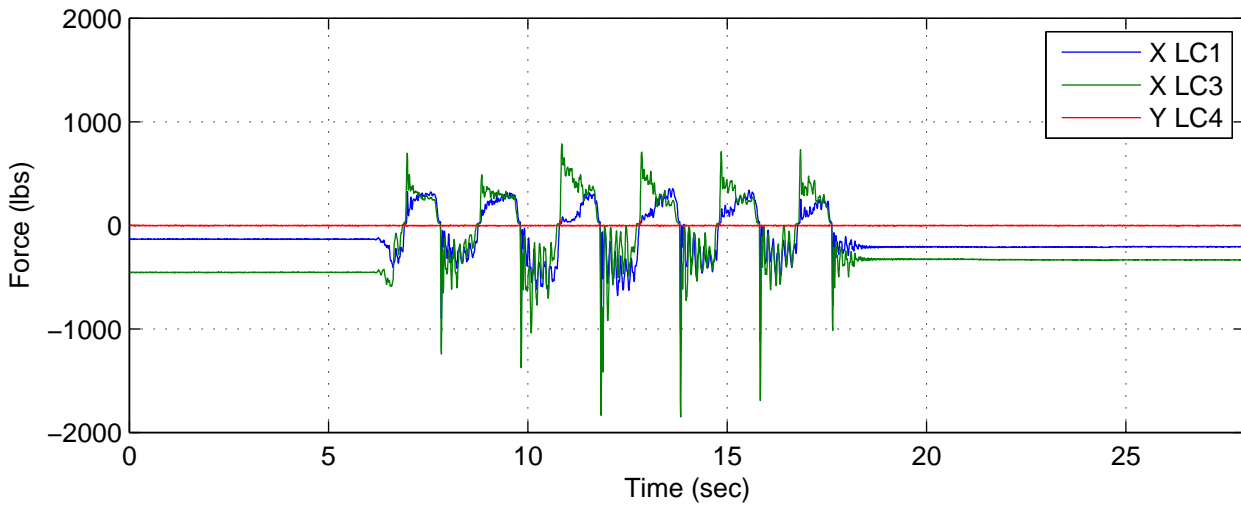
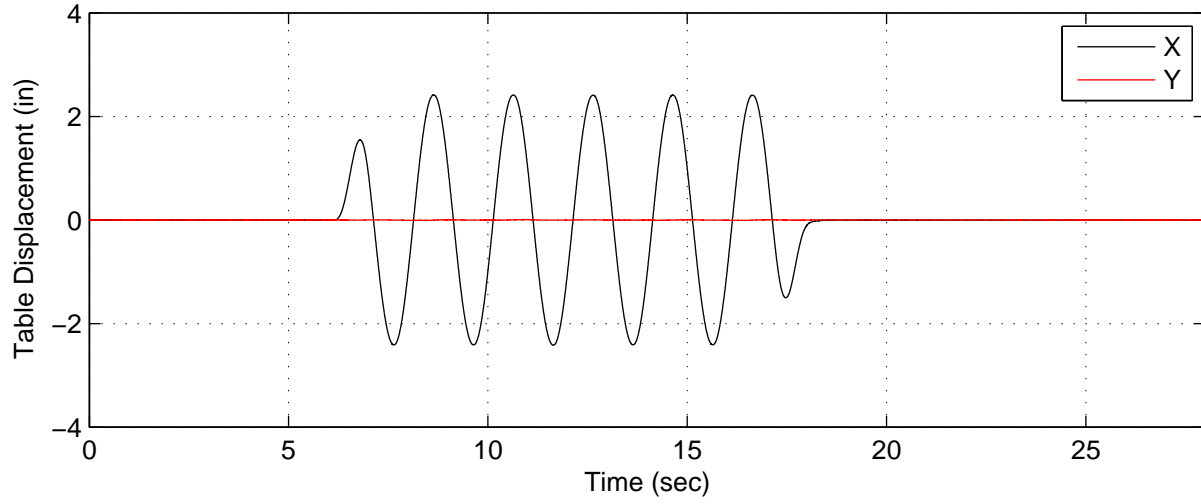

AP4 (Added Mass) – Test F, 2.5in. Dynamic X Disp

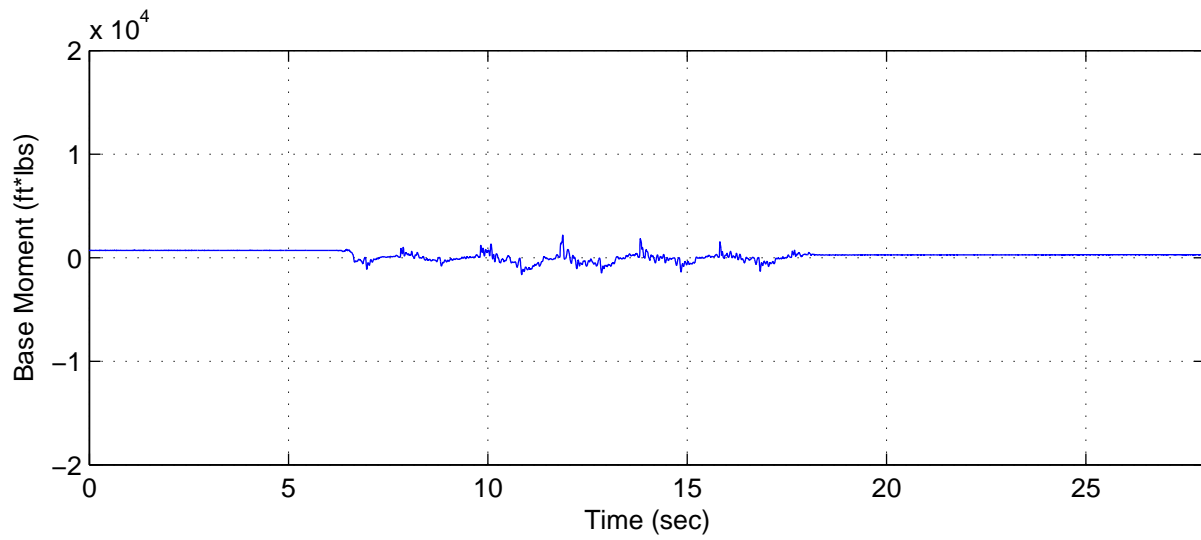
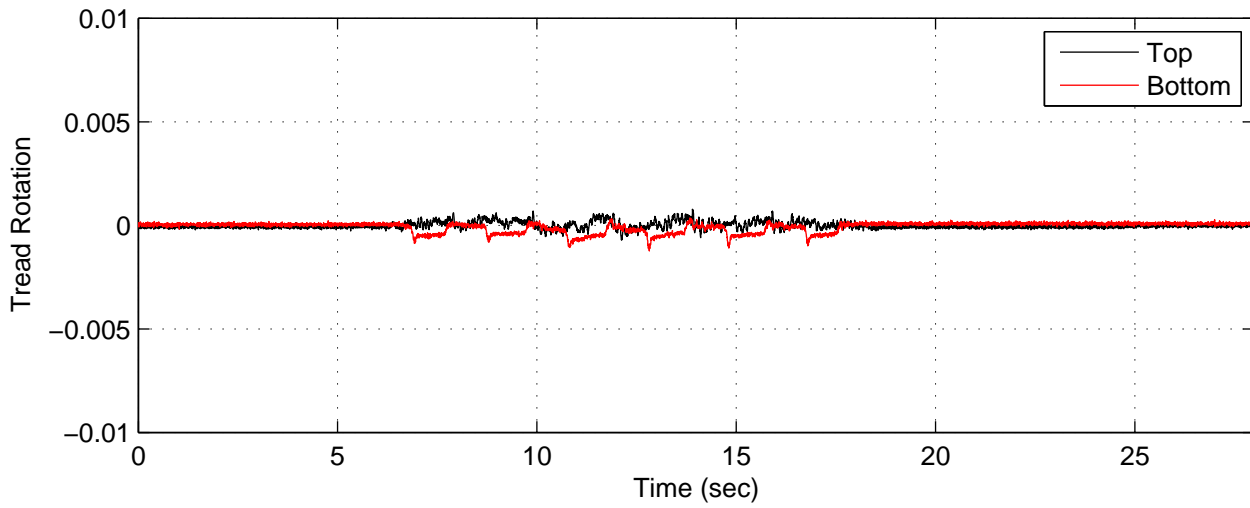
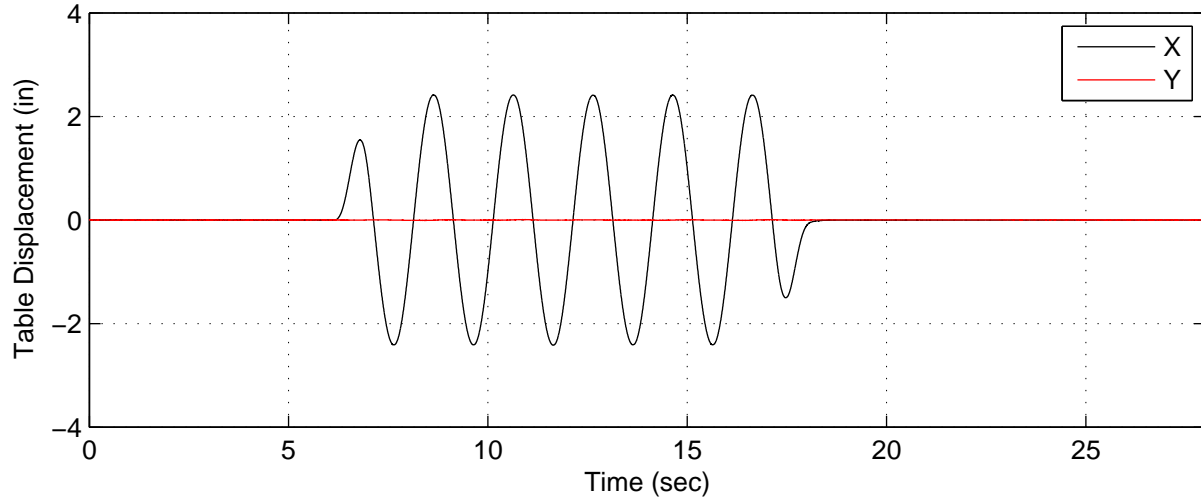

AP4 (Added Mass) – Test G, 0.5in. Dynamic Y Disp

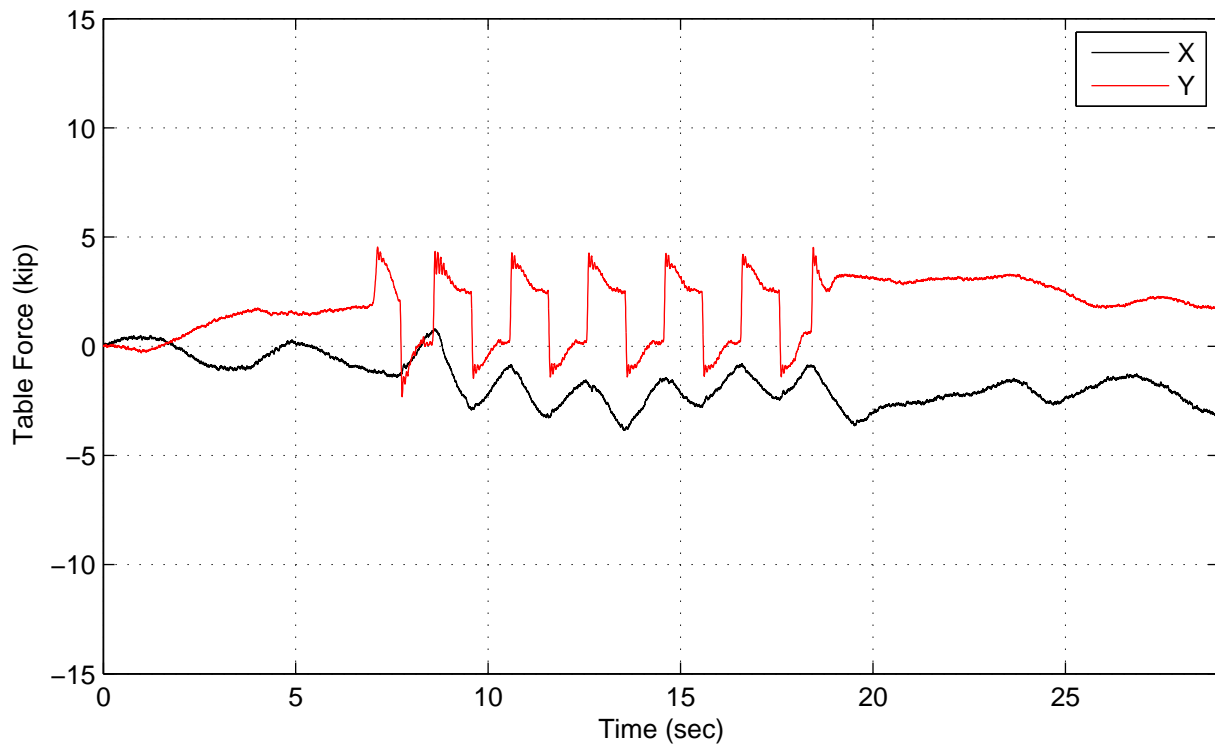
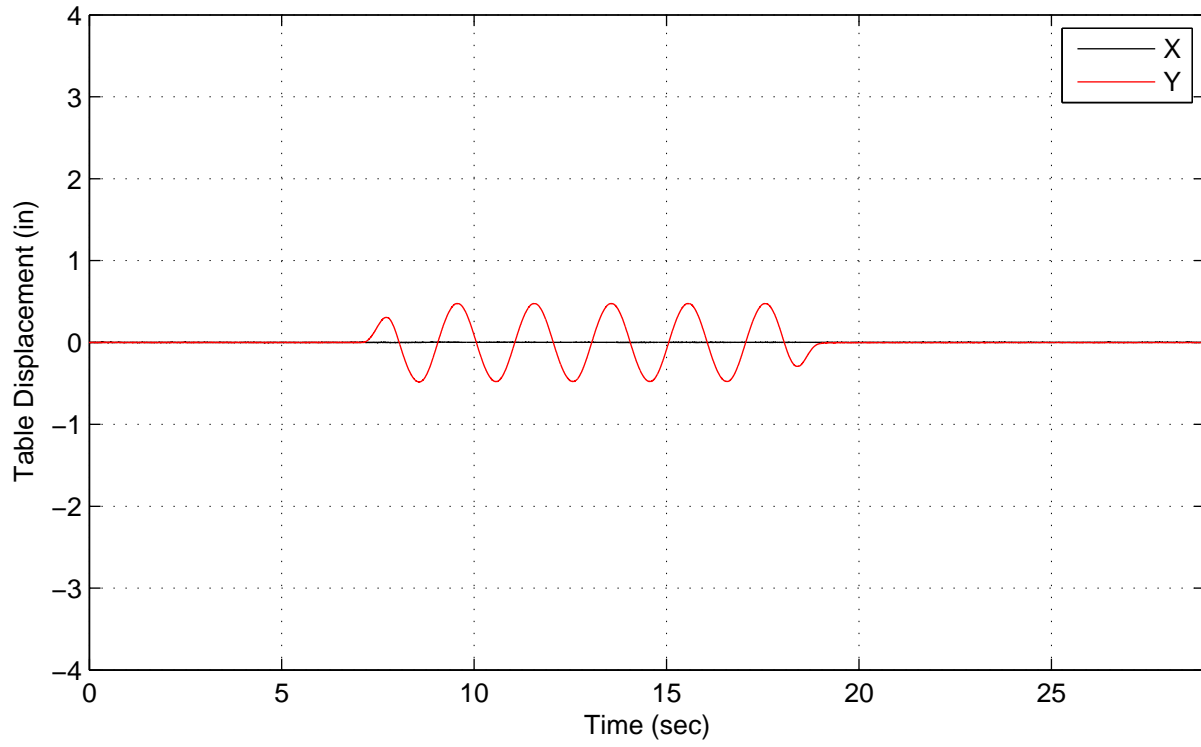



AP4 (Added Mass) – Test G, 0.5in. Dynamic Y Disp

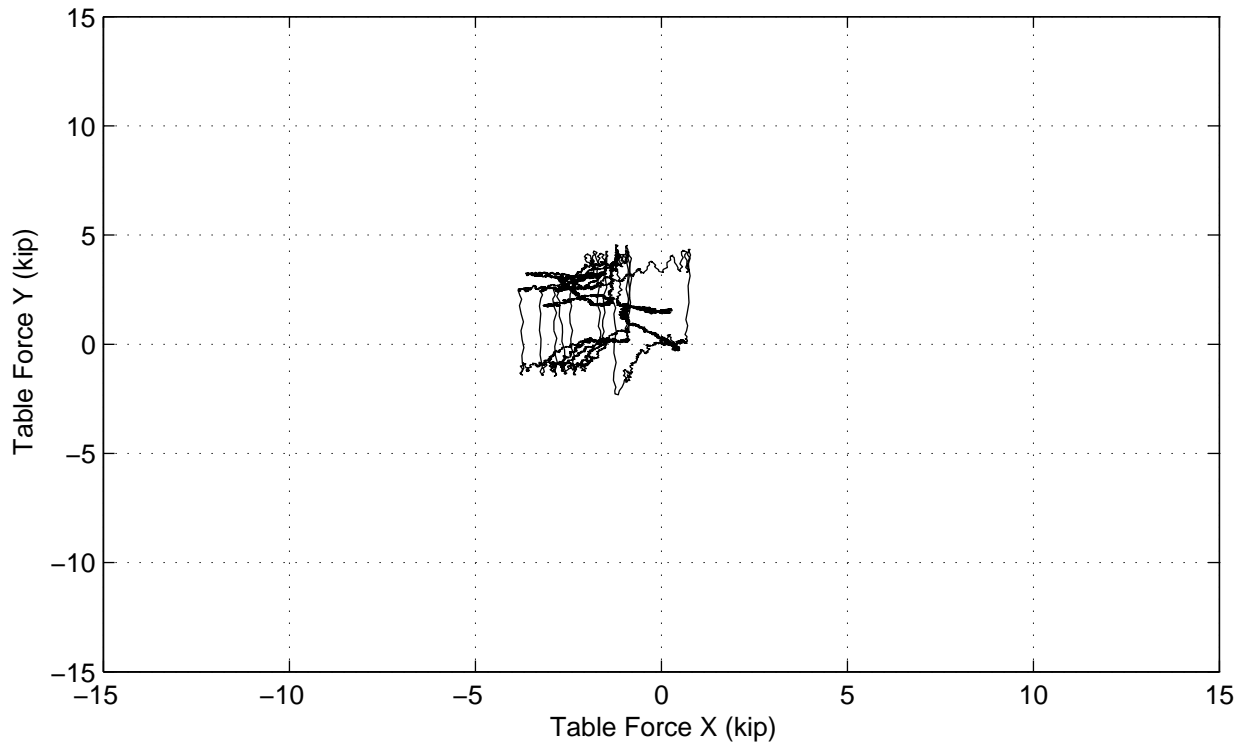
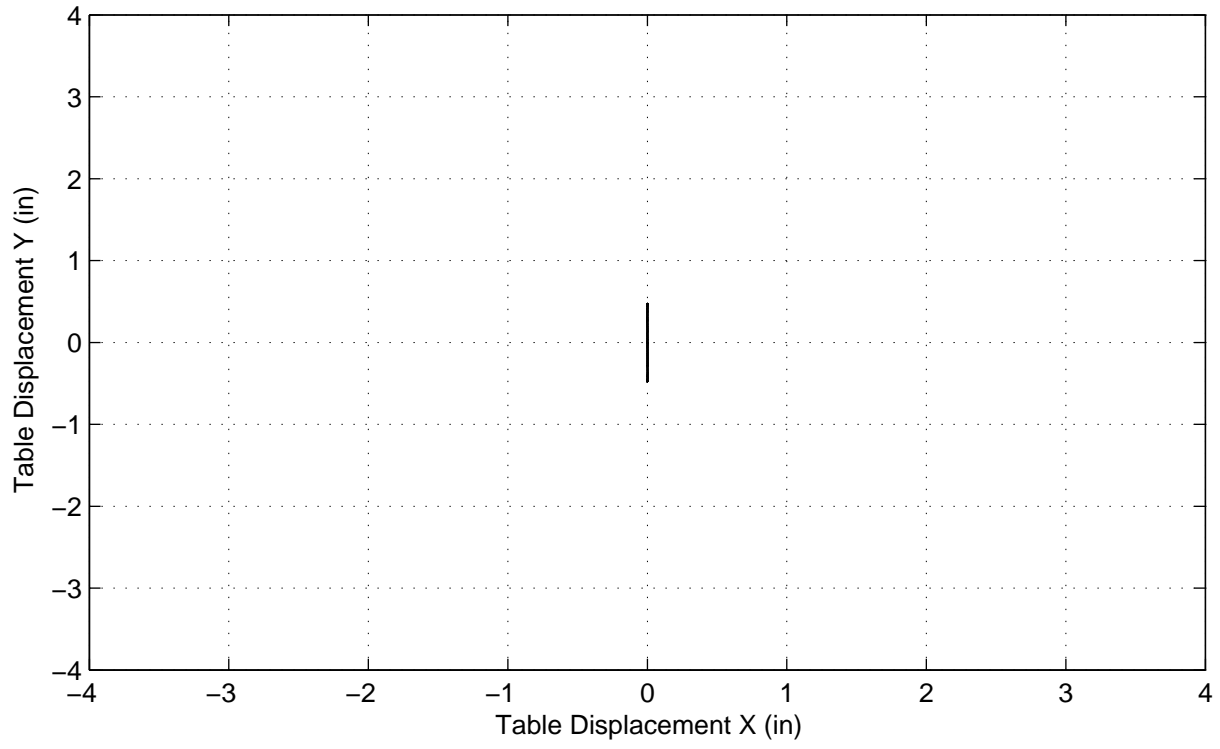

AP4 (Added Mass) – Test G, 0.5in. Dynamic Y Disp

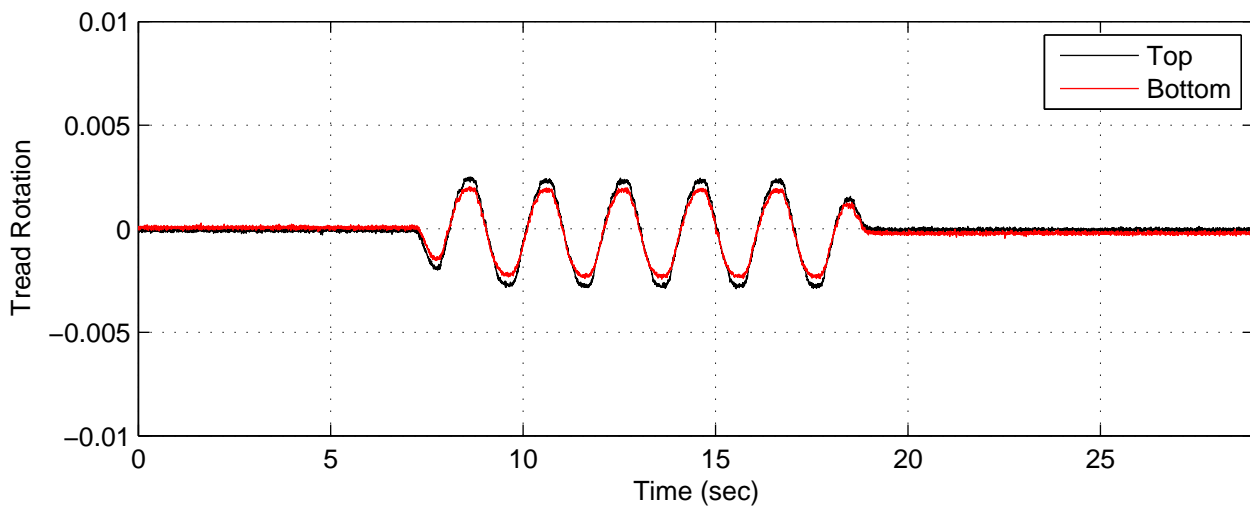
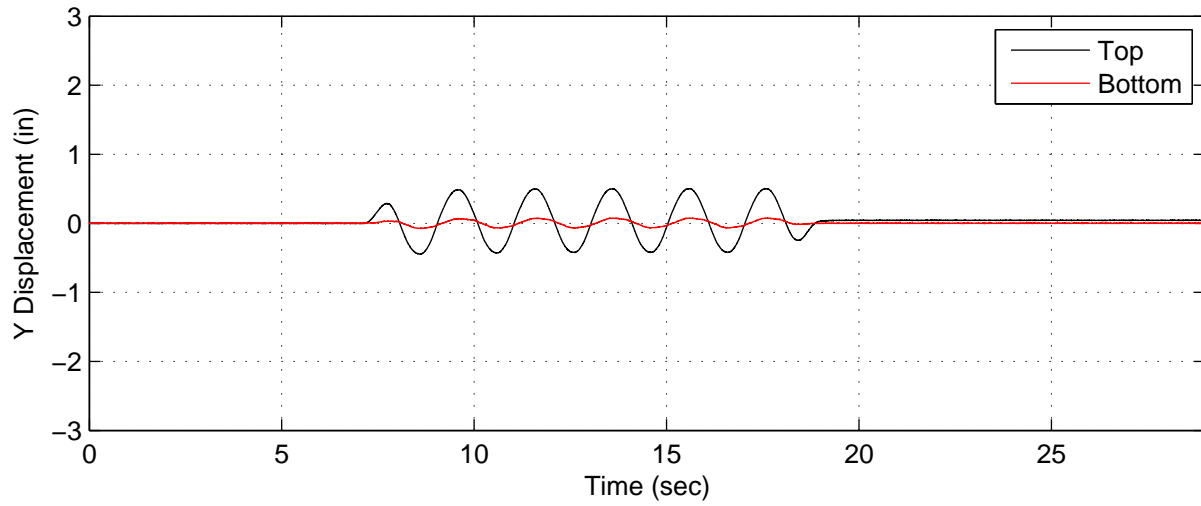
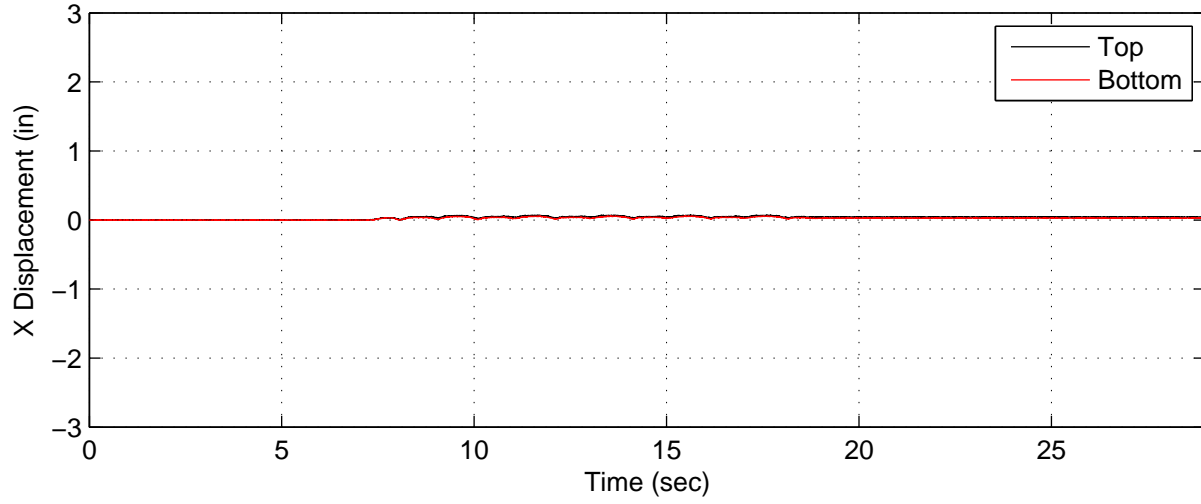

AP4 (Added Mass) – Test G, 0.5in. Dynamic Y Disp

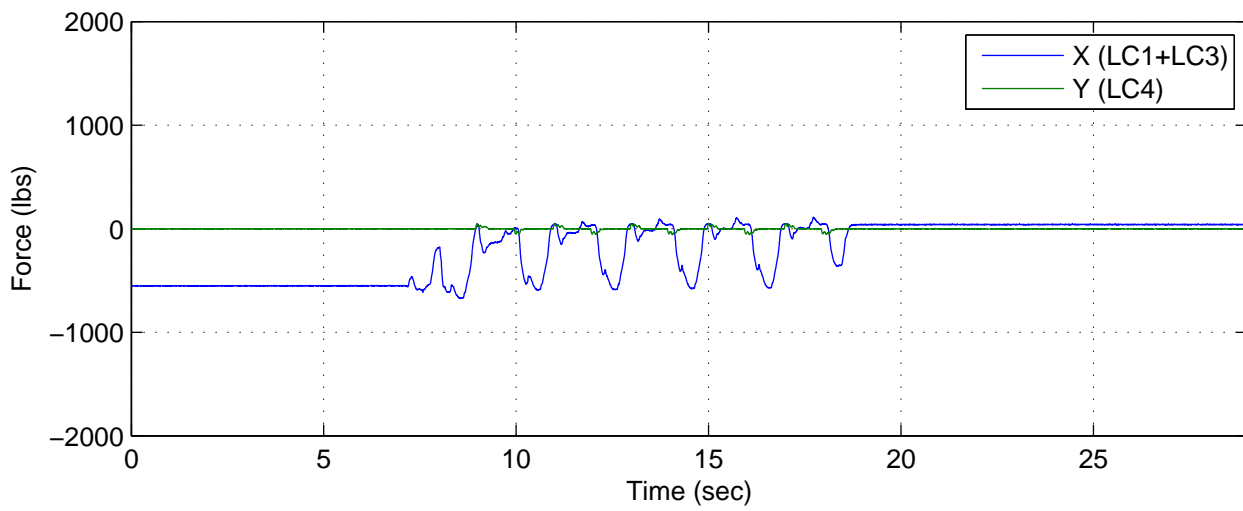
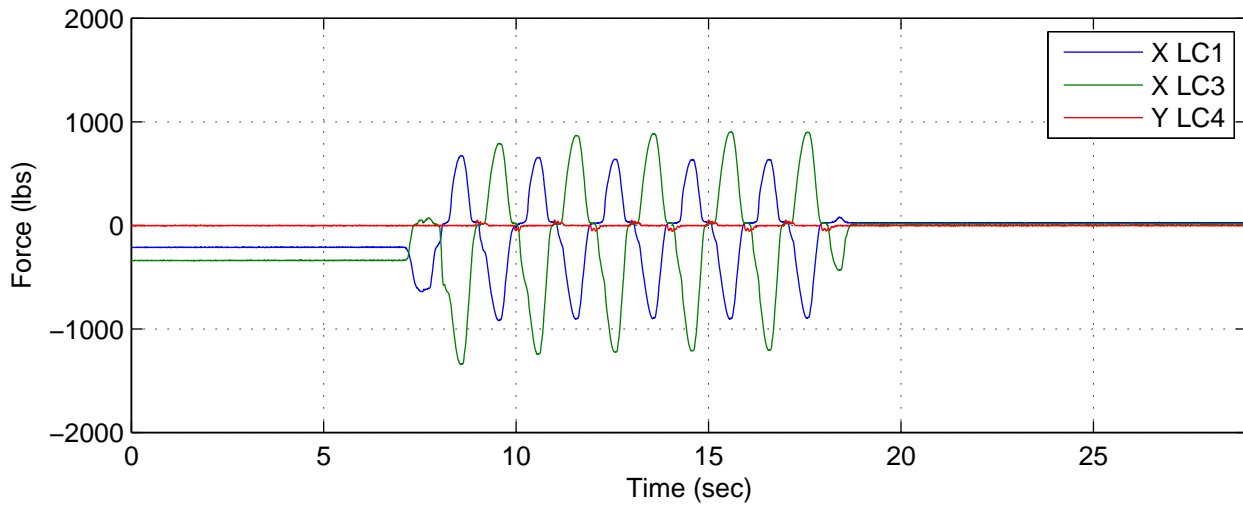
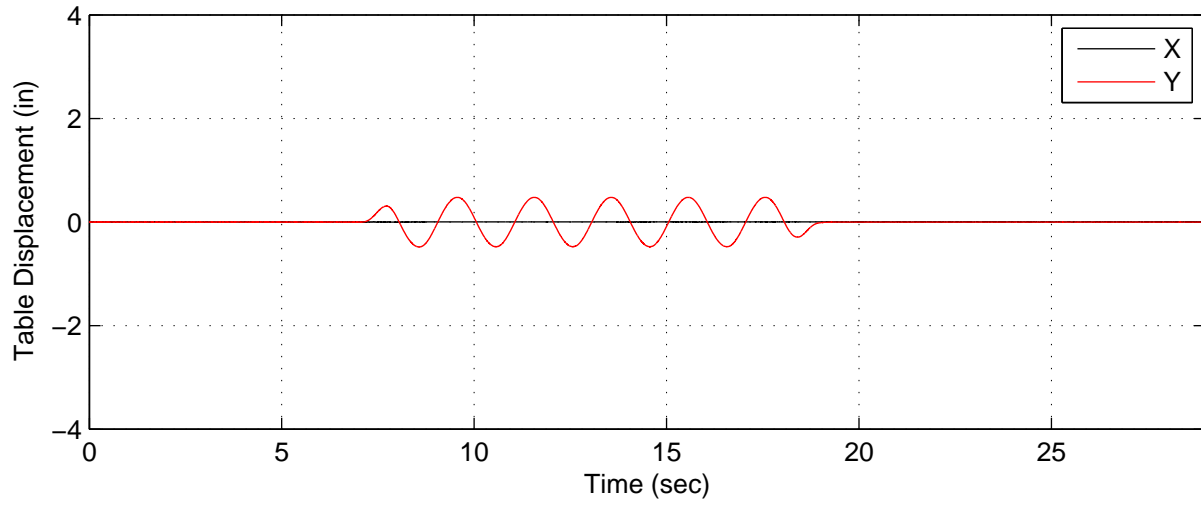

AP4 (Added Mass) – Test G, 0.5in. Dynamic Y Disp

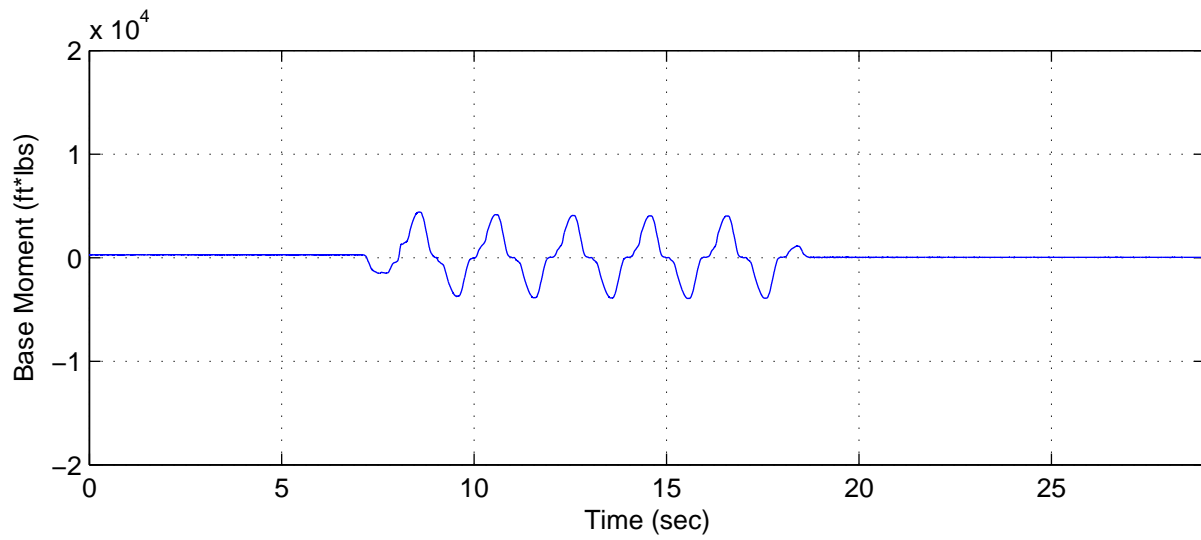
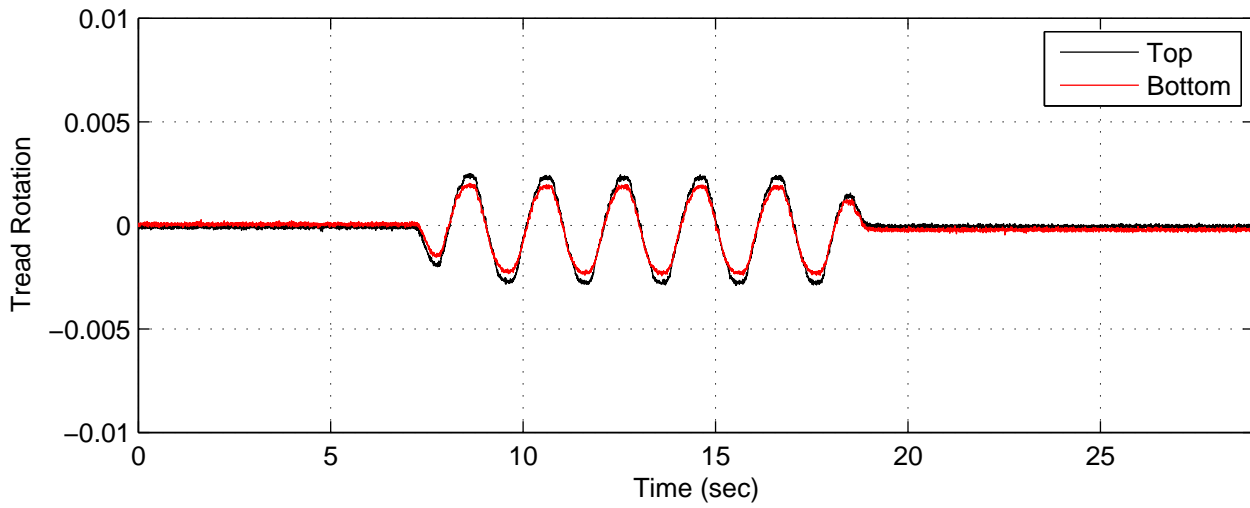
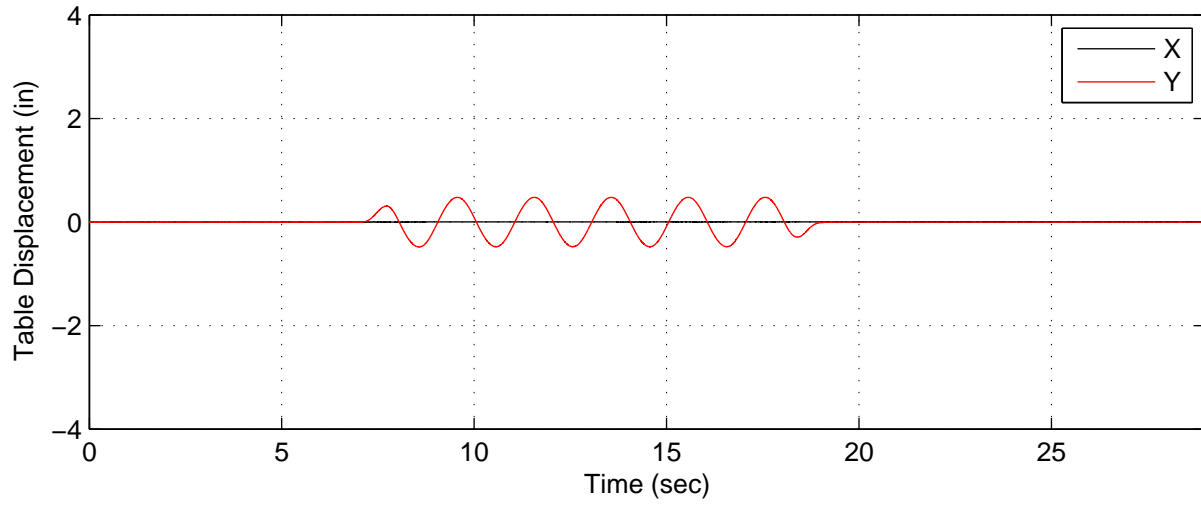

AP4 (Added Mass) – Test H, 2.5in. Dynamic Y Disp

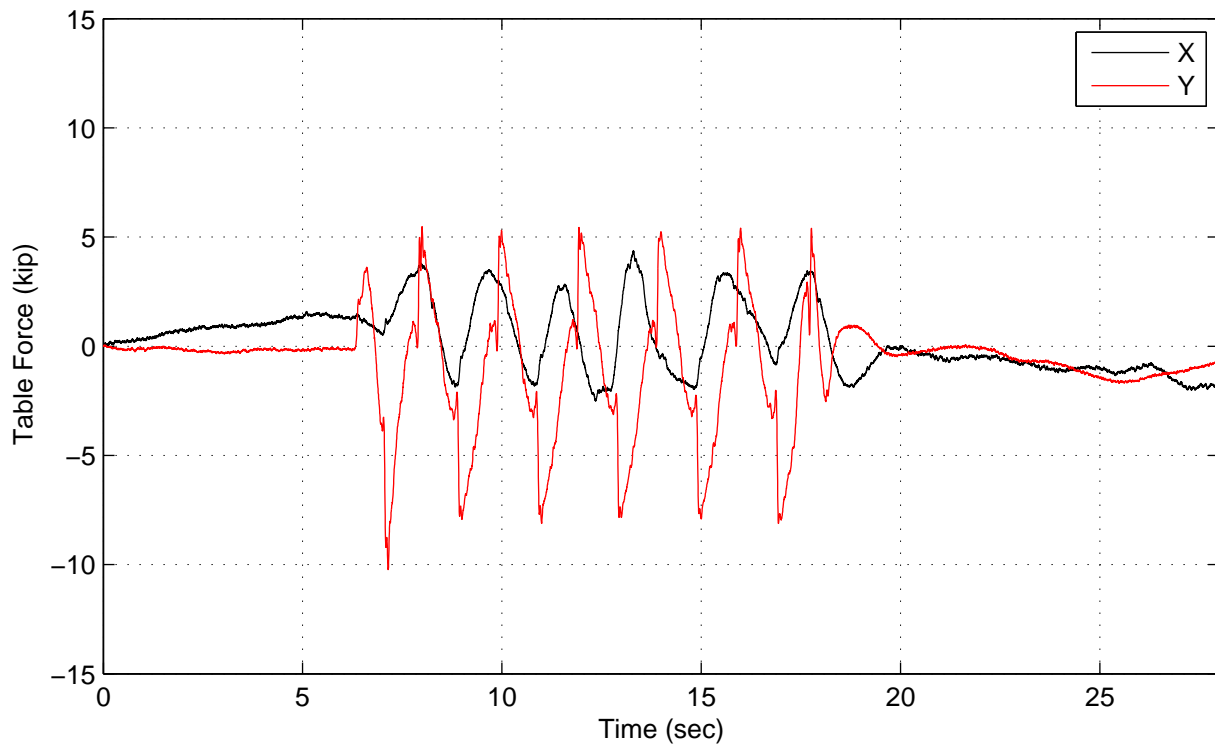
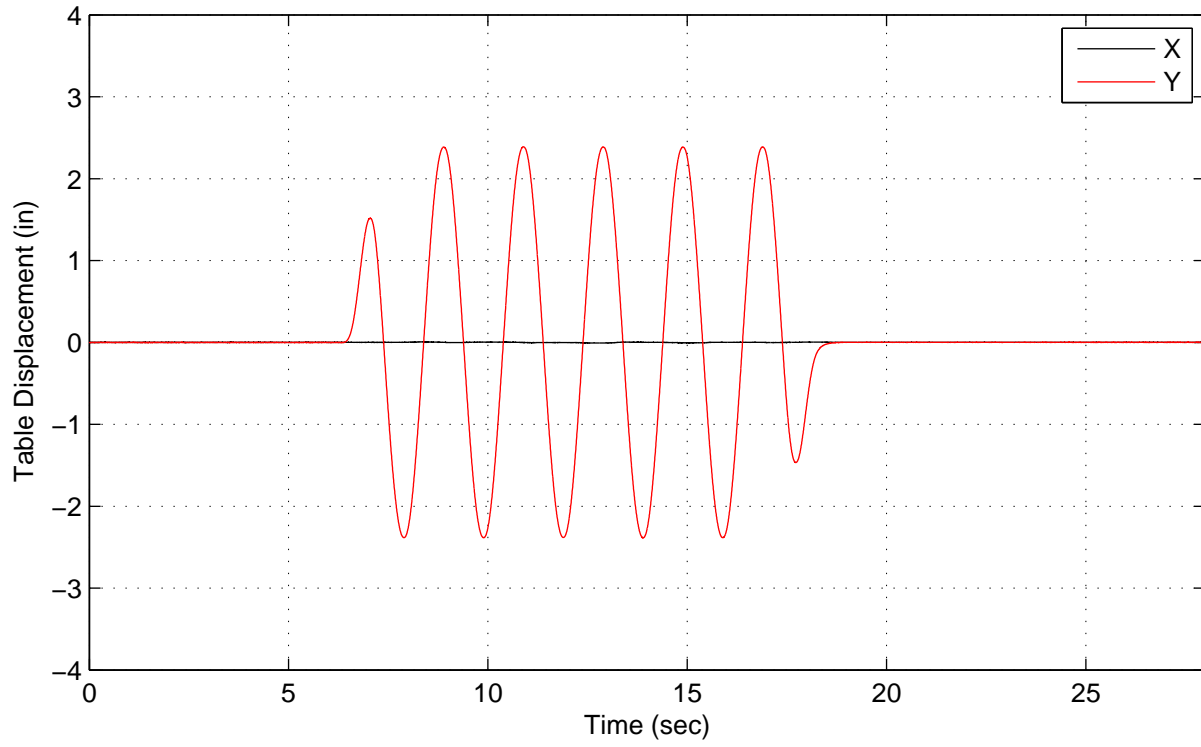

AP4 (Added Mass) – Test H, 2.5in. Dynamic Y Disp

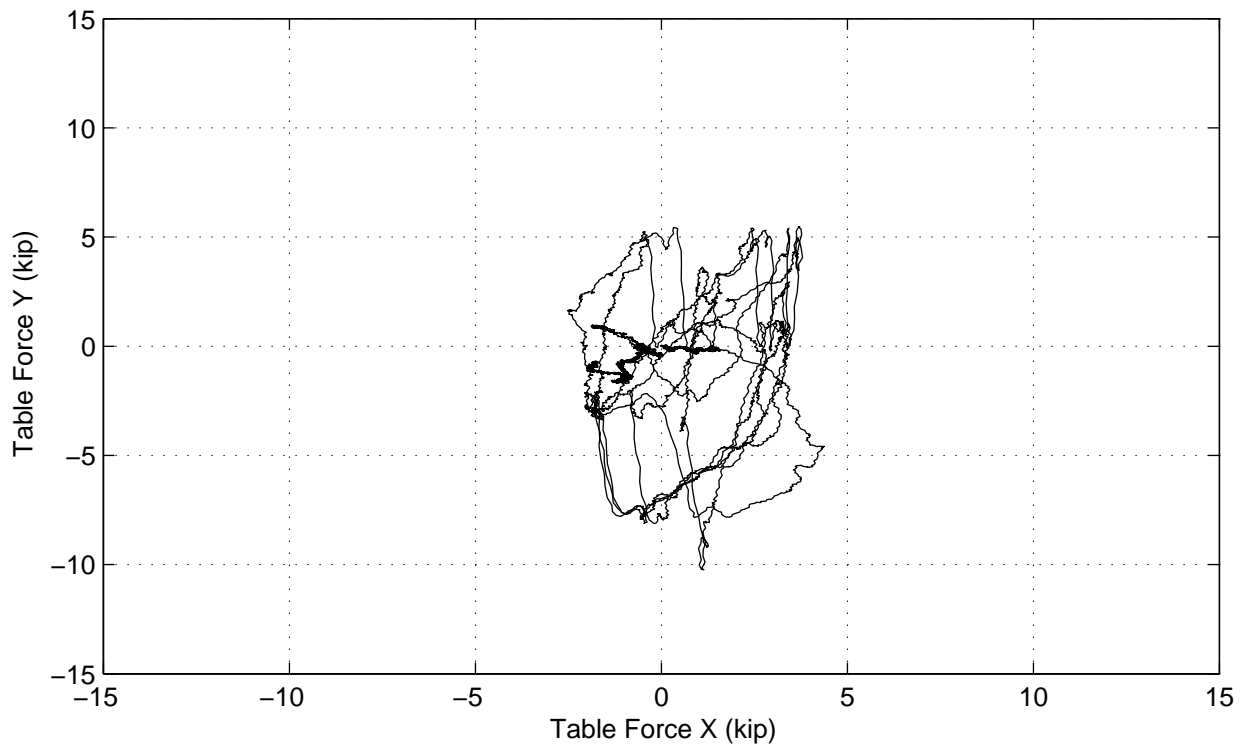
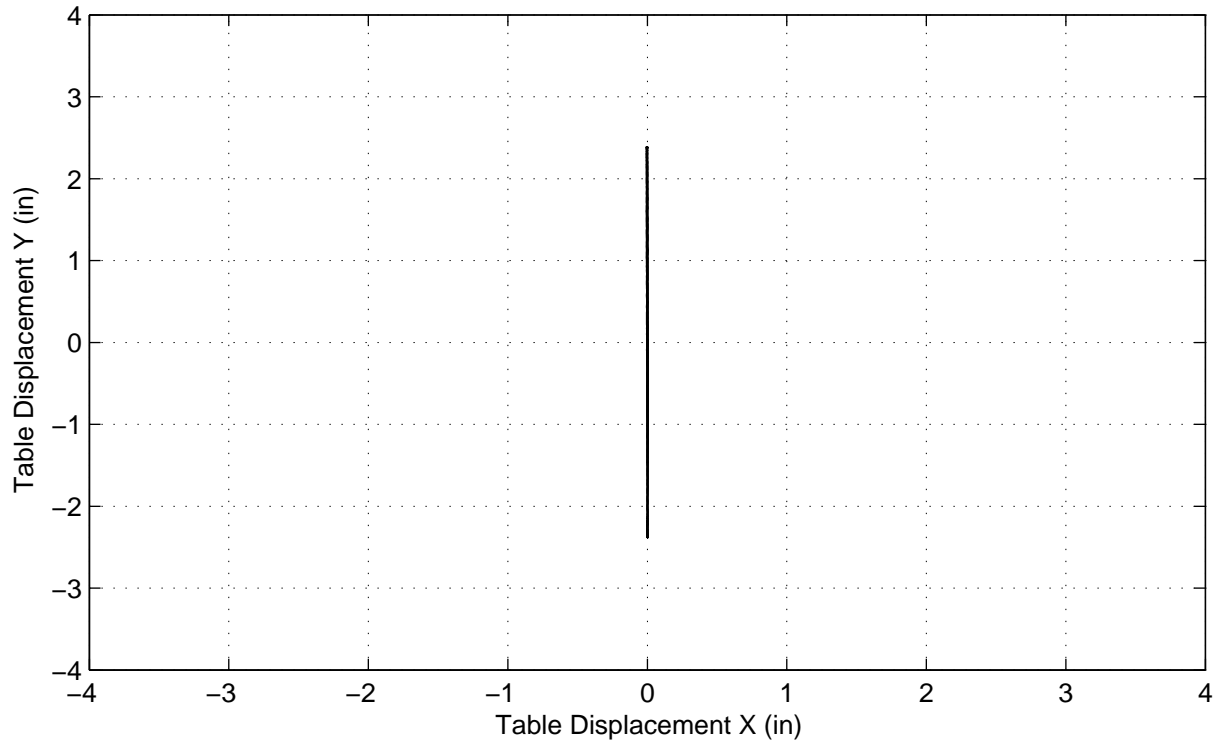

AP4 (Added Mass) – Test H, 2.5in. Dynamic Y Disp

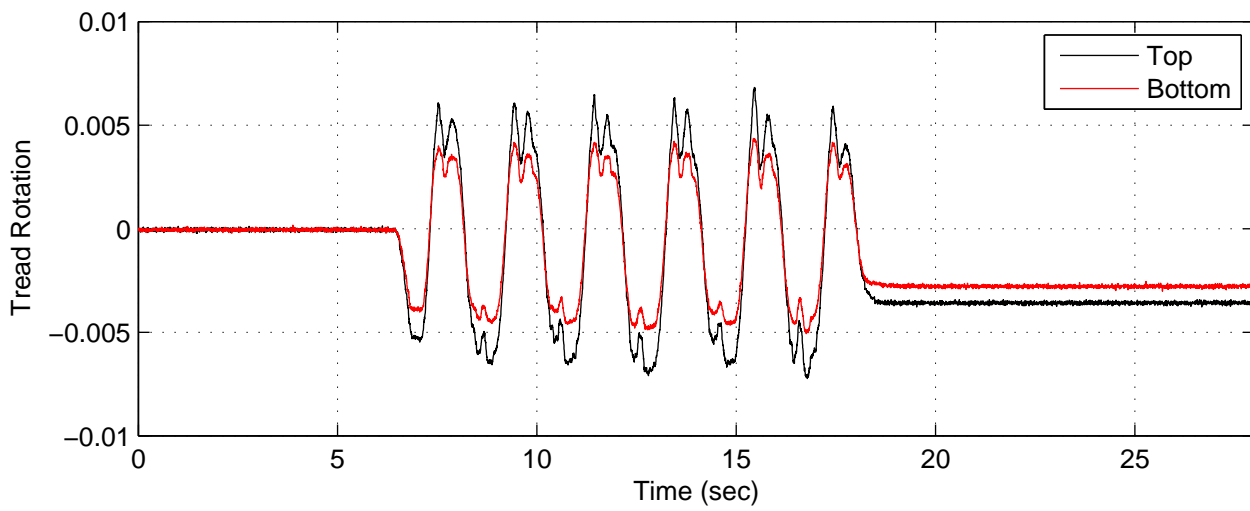
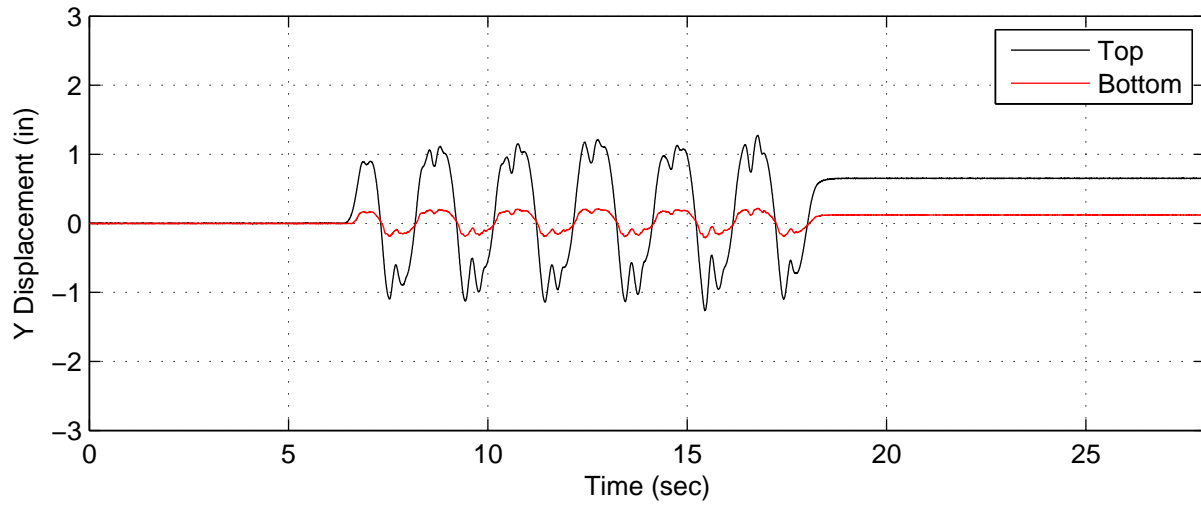
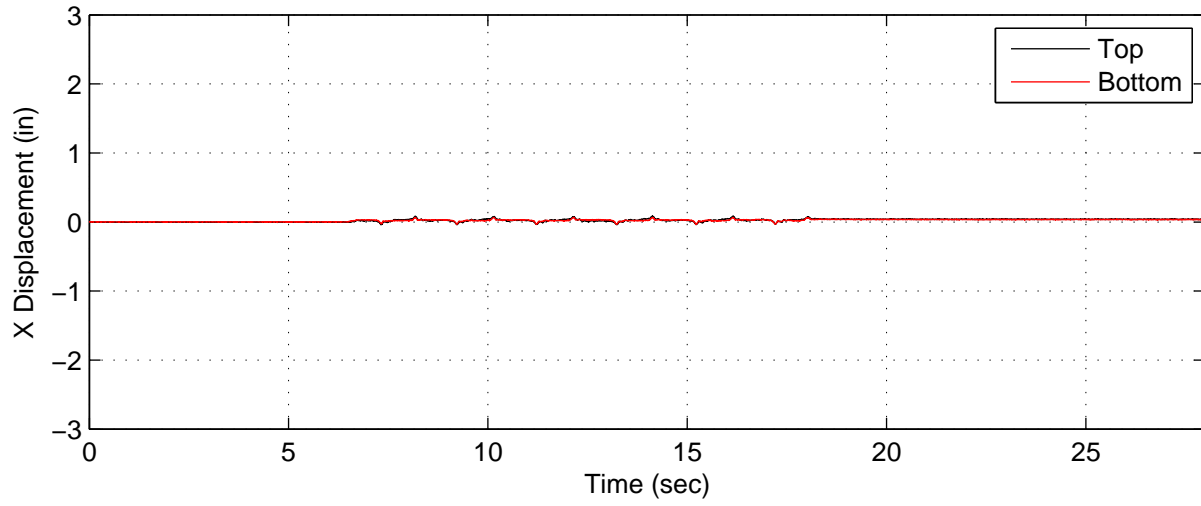

AP4 (Added Mass) – Test H, 2.5in. Dynamic Y Disp

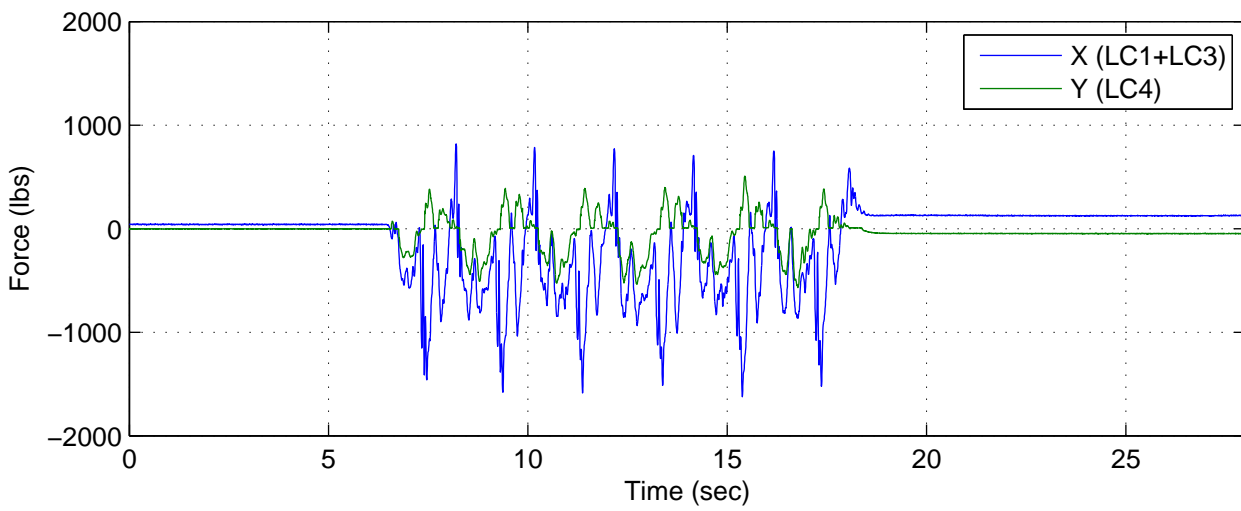
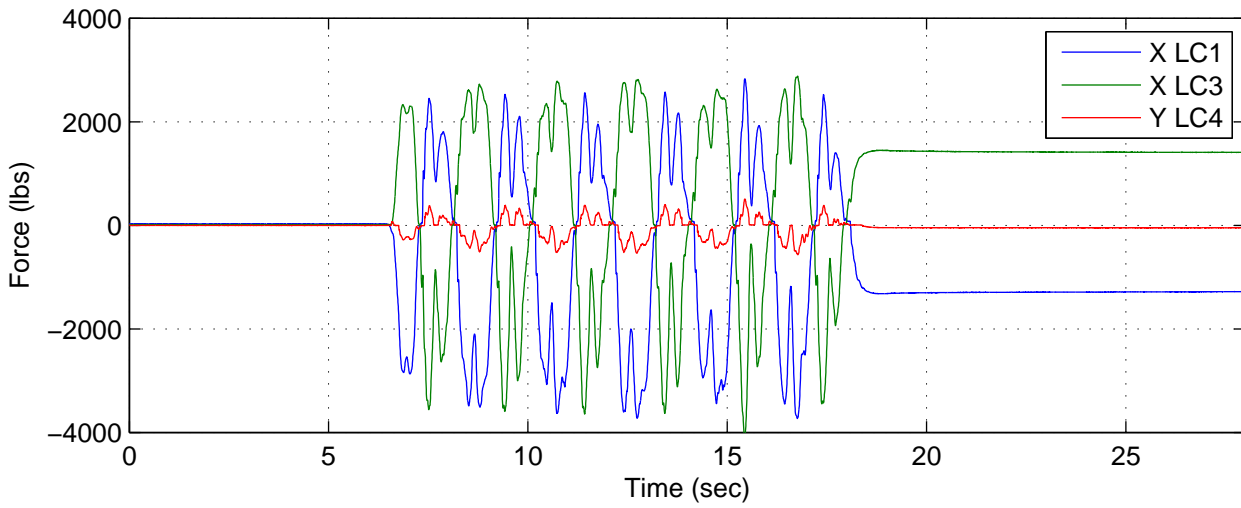
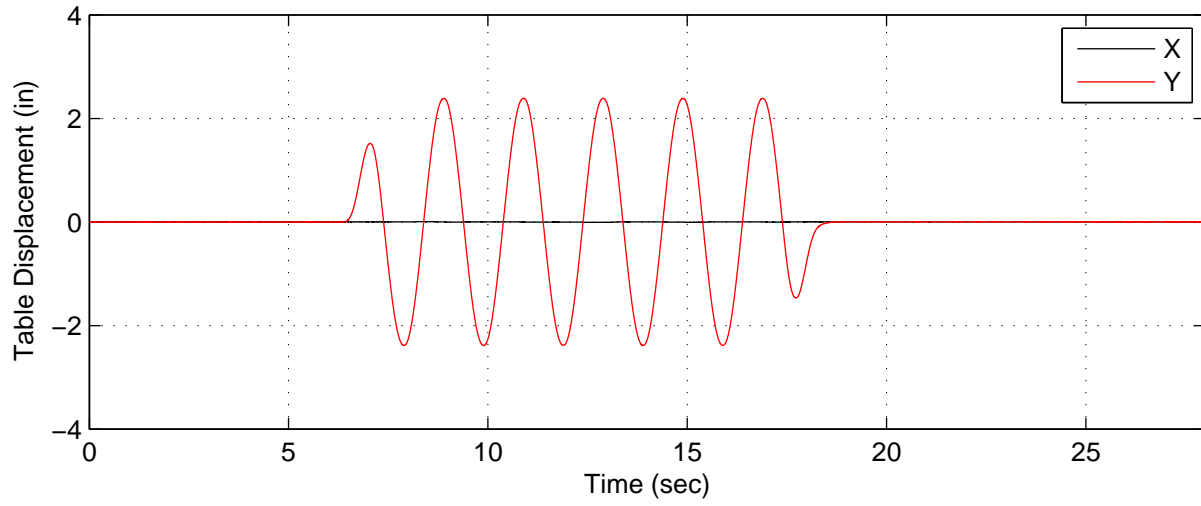



AP4 (Added Mass) – Test H, 2.5in. Dynamic Y Disp

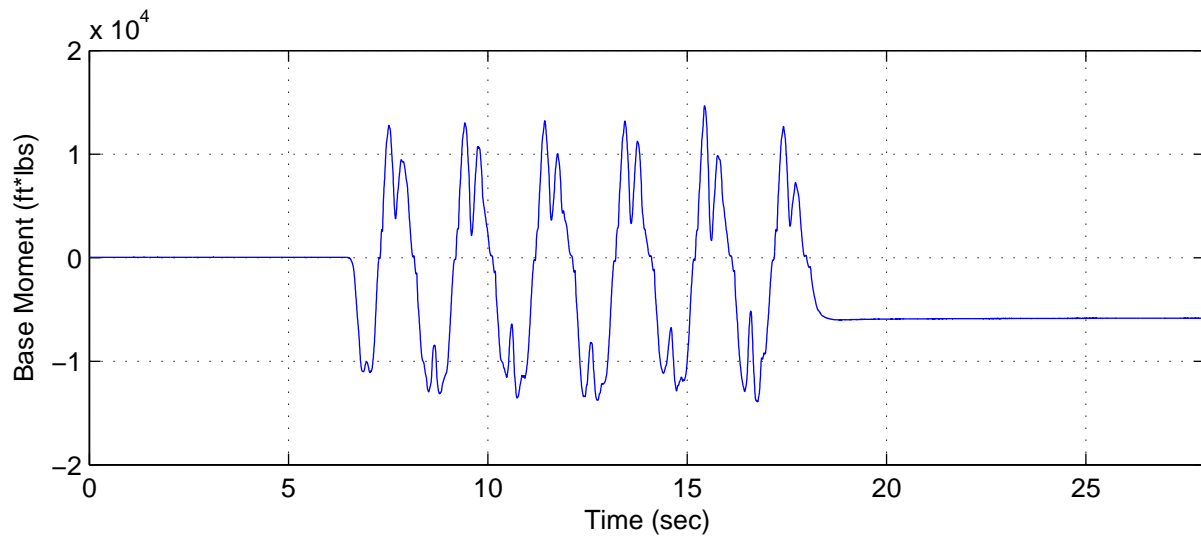
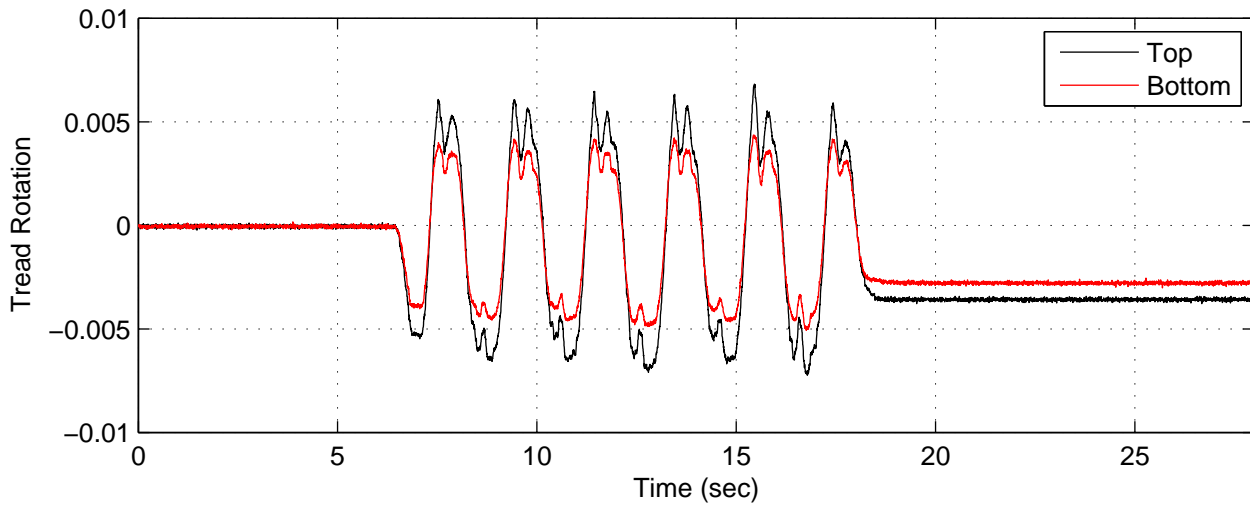
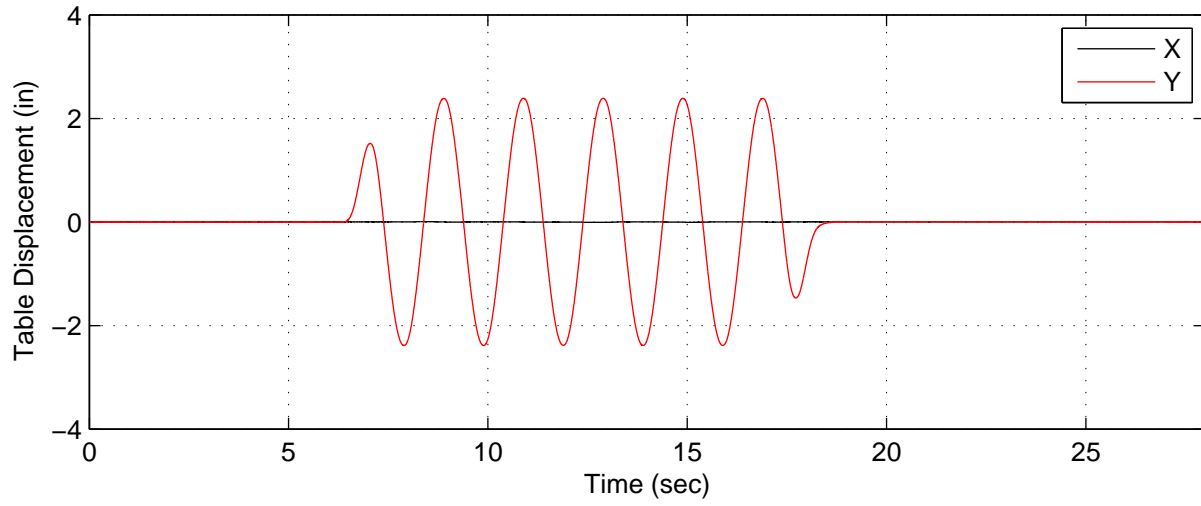

AP4 (Added Mass) – Test I, 0.5in. Dynamic X+Y Disp

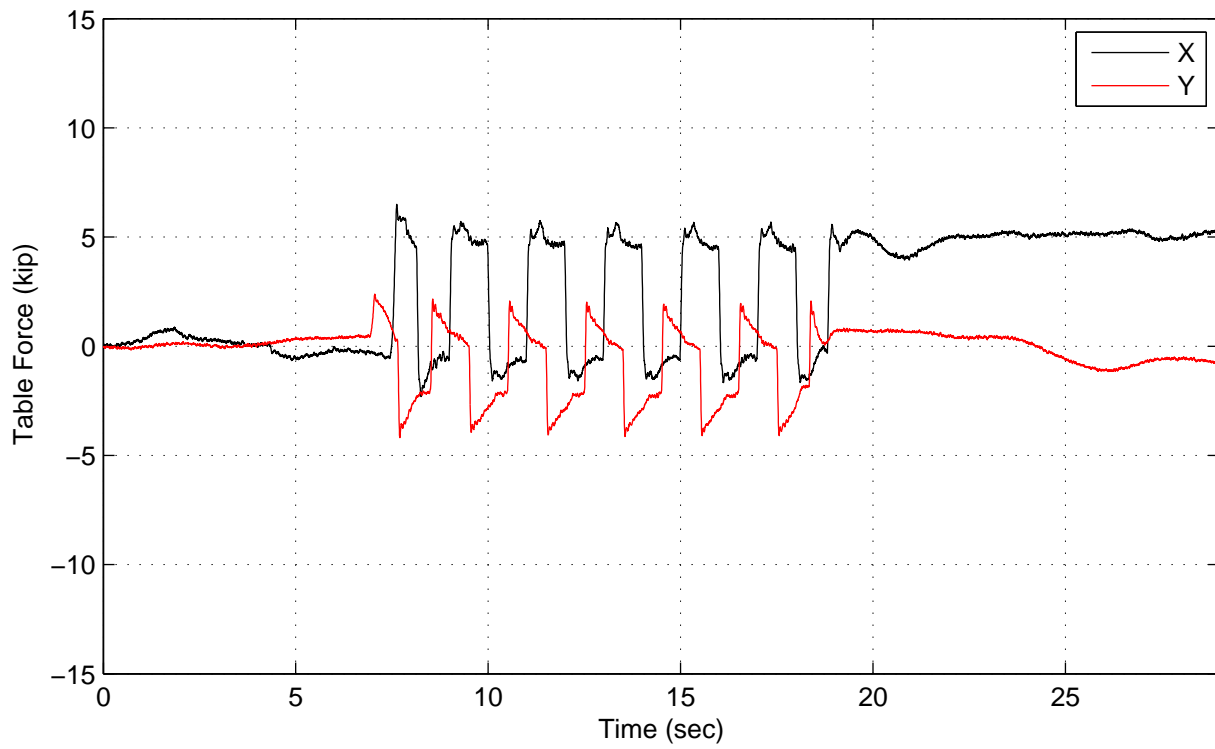
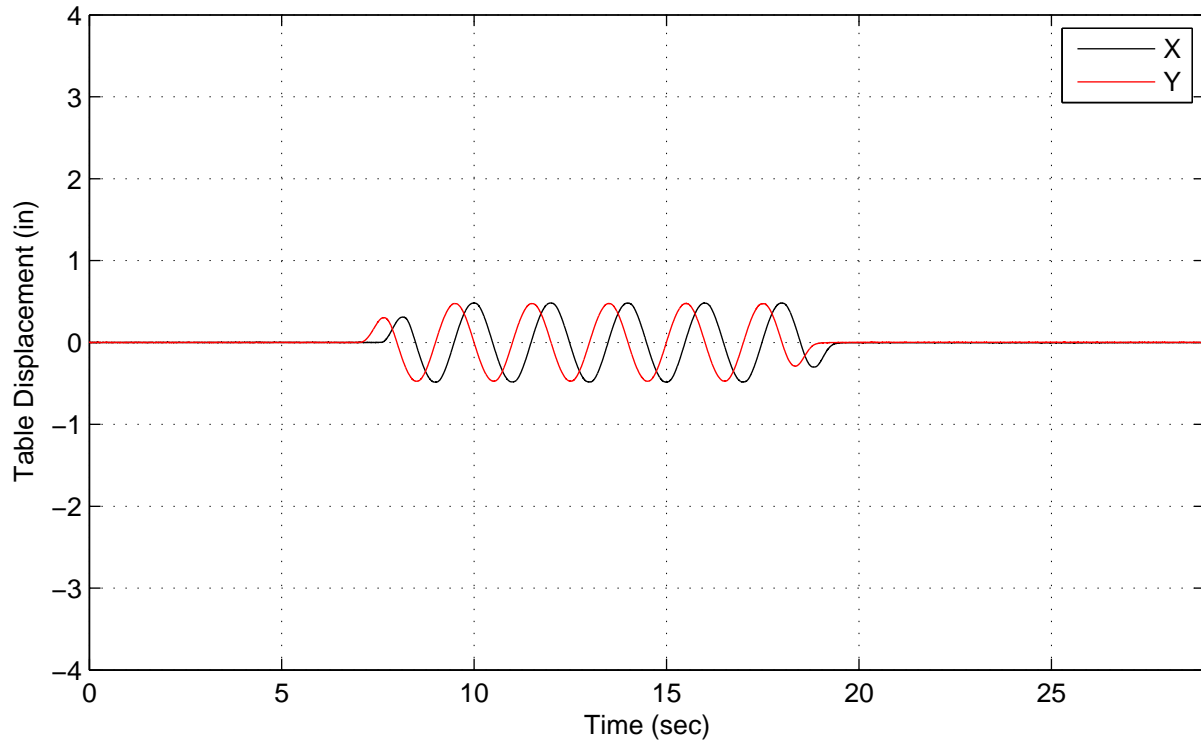

AP4 (Added Mass) – Test I, 0.5in. Dynamic X+Y Disp

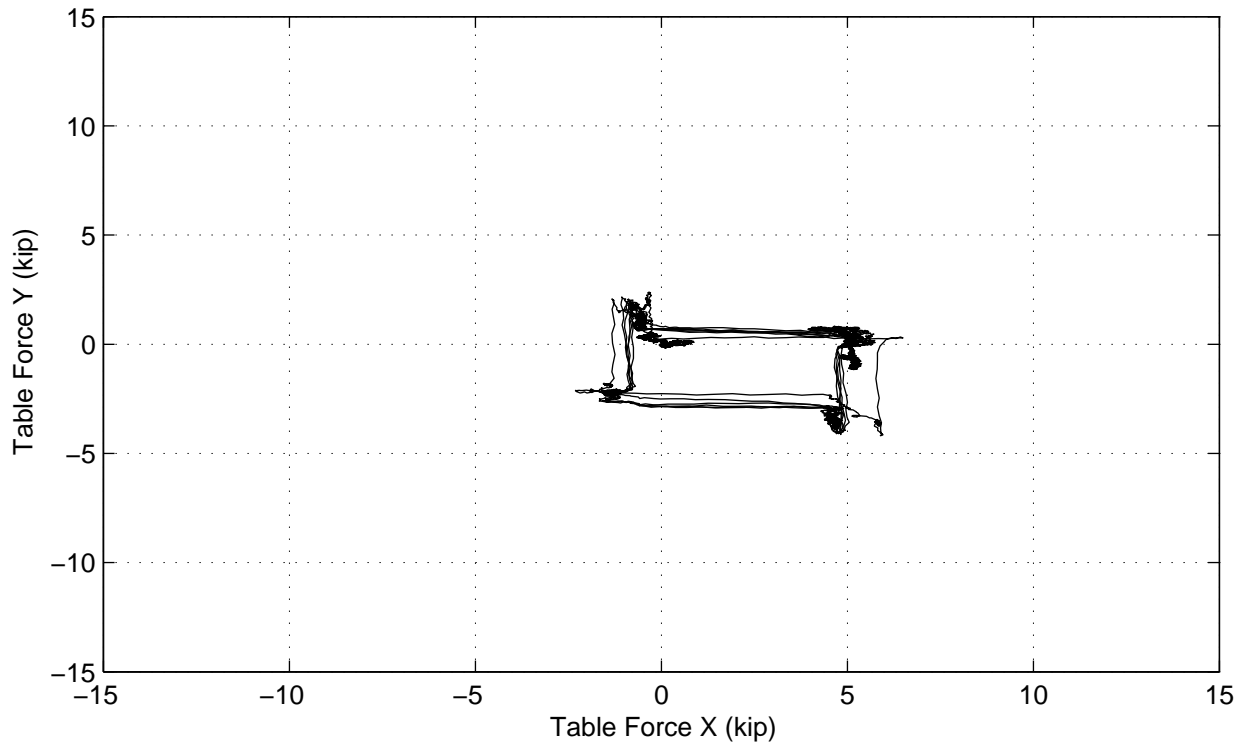
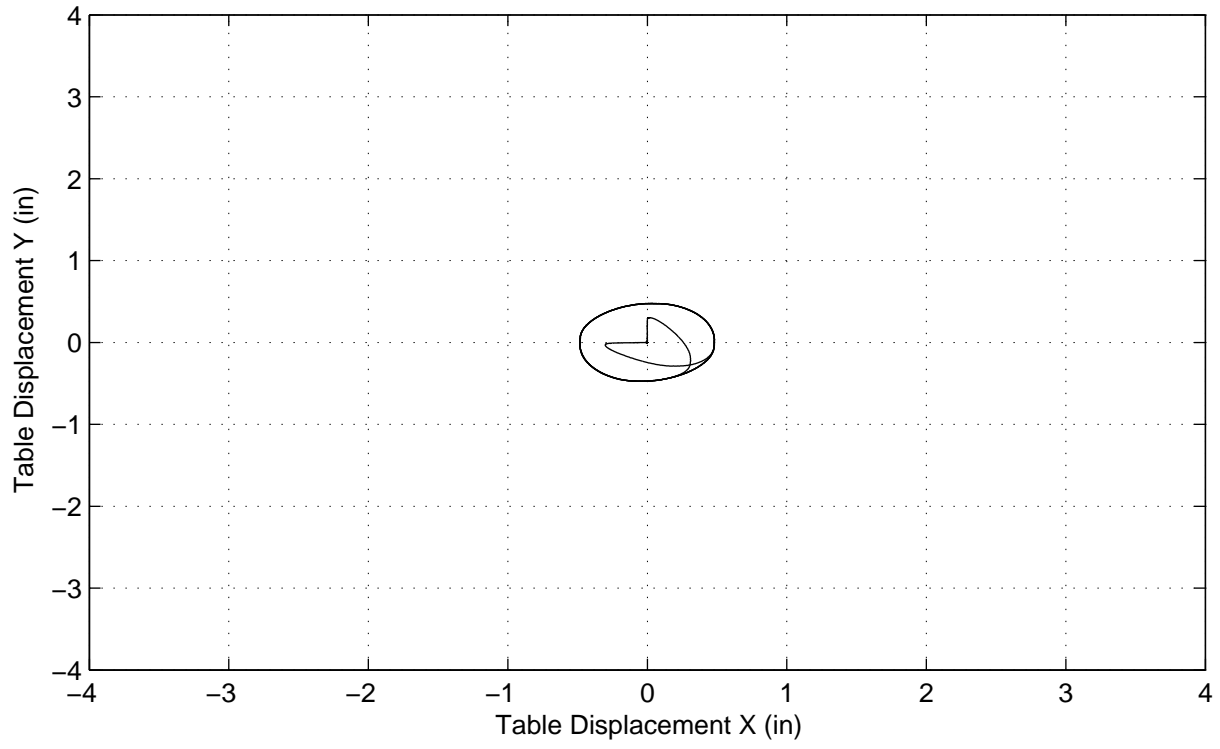

AP4 (Added Mass) – Test I, 0.5in. Dynamic X+Y Disp

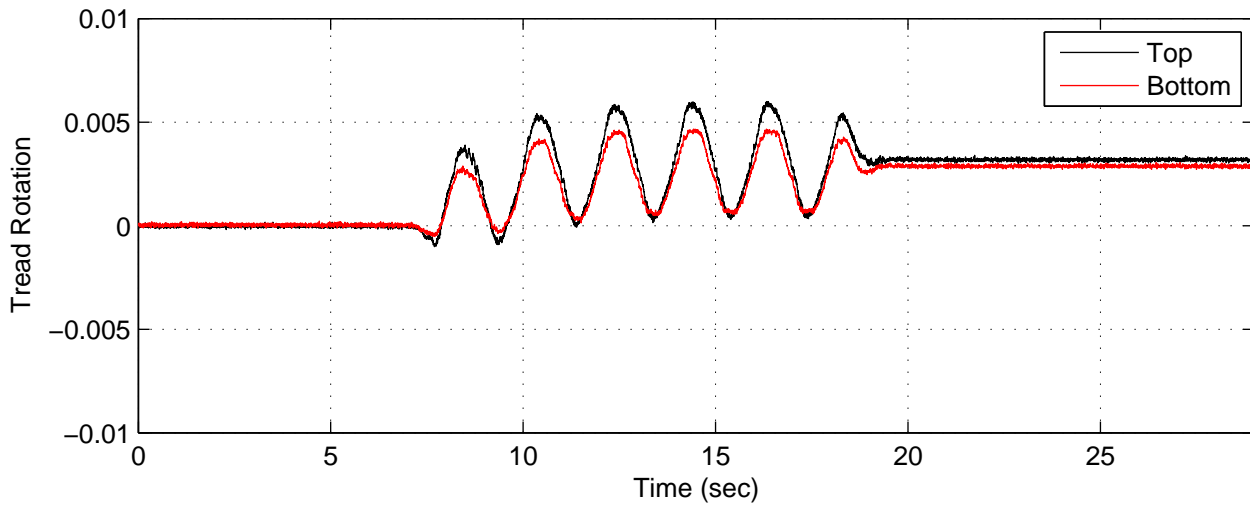
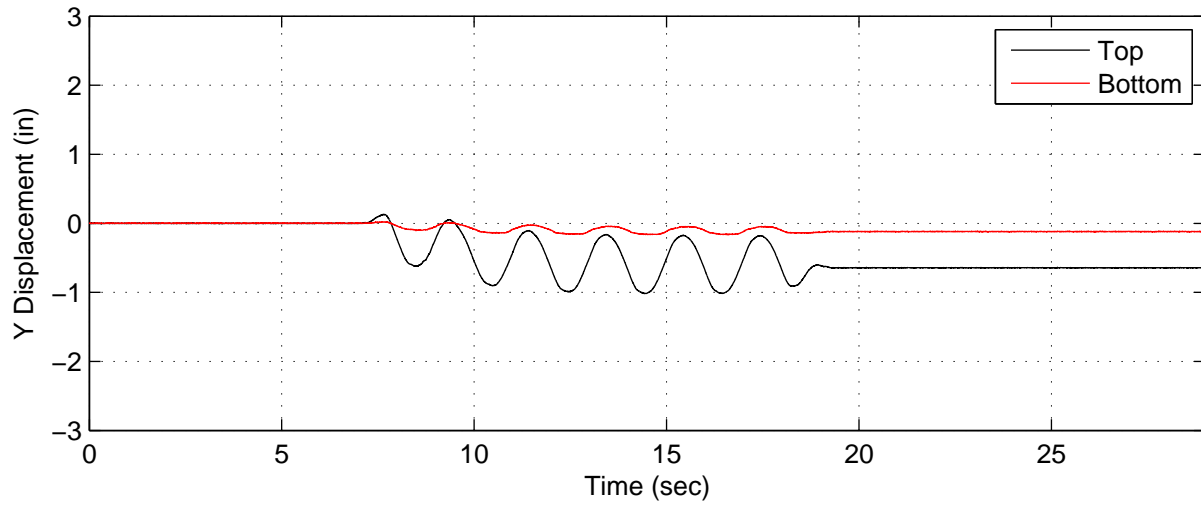
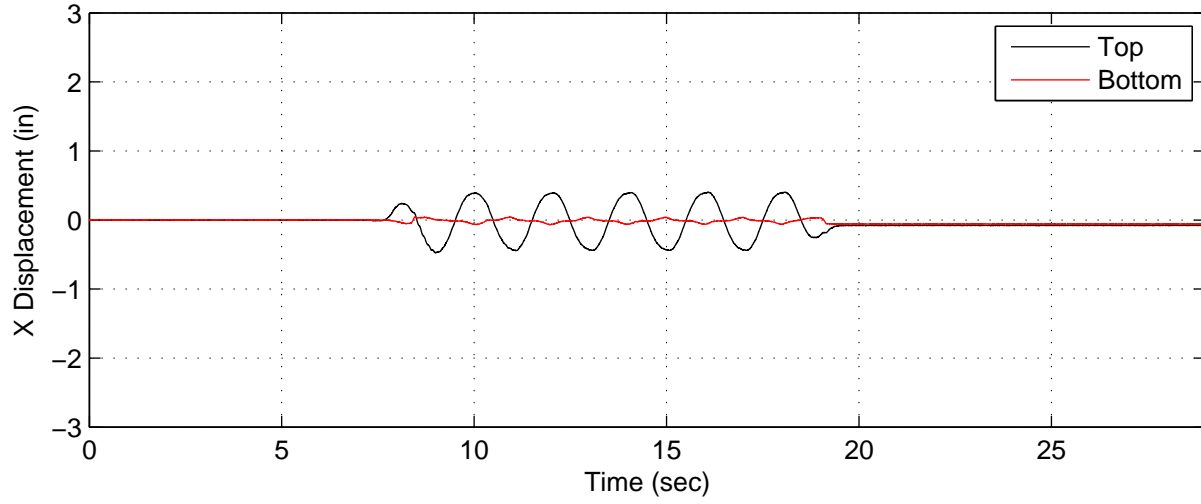

AP4 (Added Mass) – Test I, 0.5in. Dynamic X+Y Disp

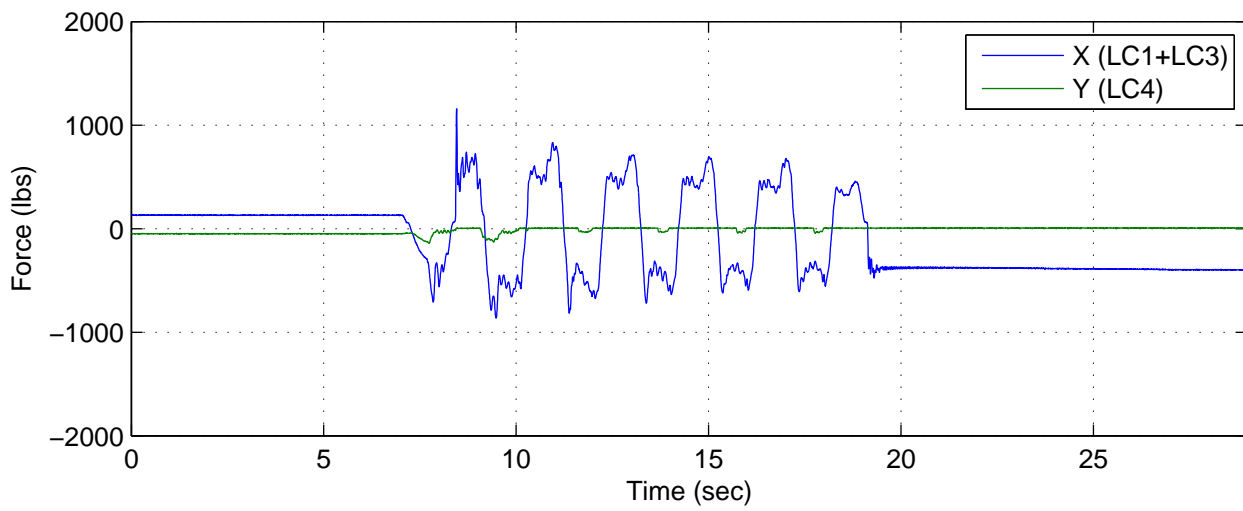
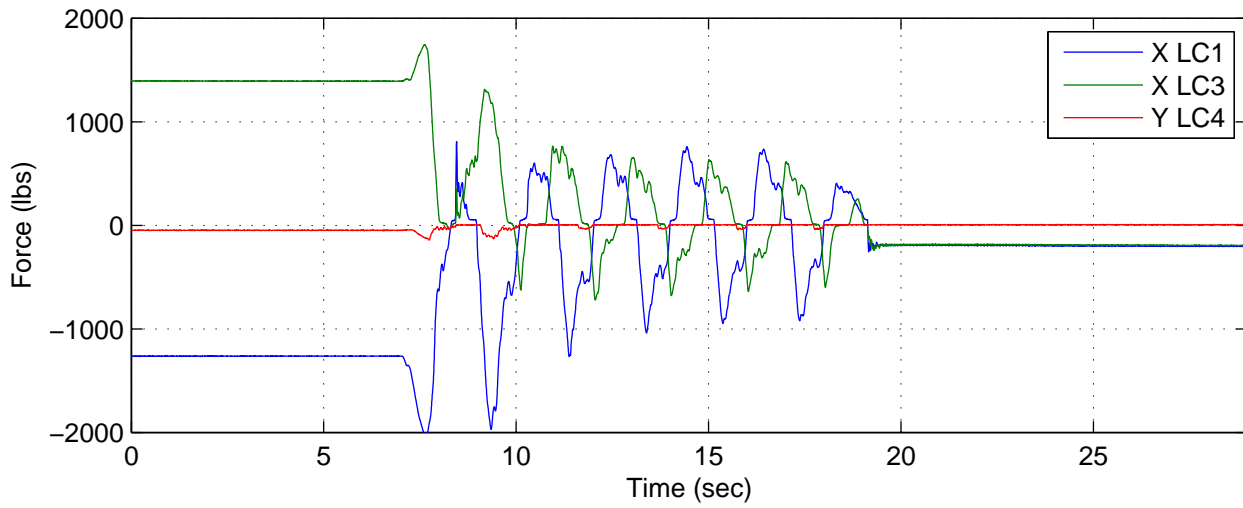
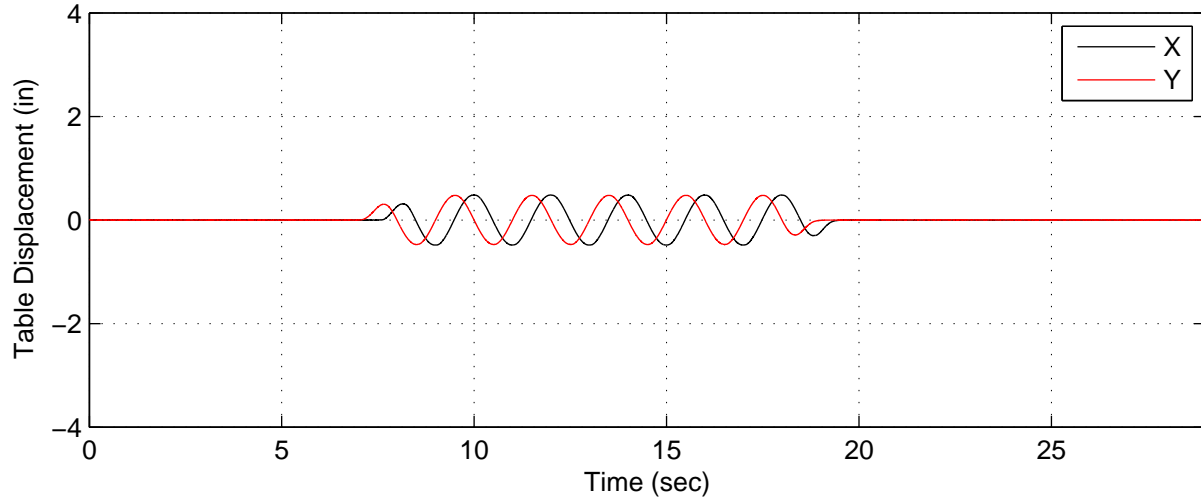

AP4 (Added Mass) – Test I, 0.5in. Dynamic X+Y Disp

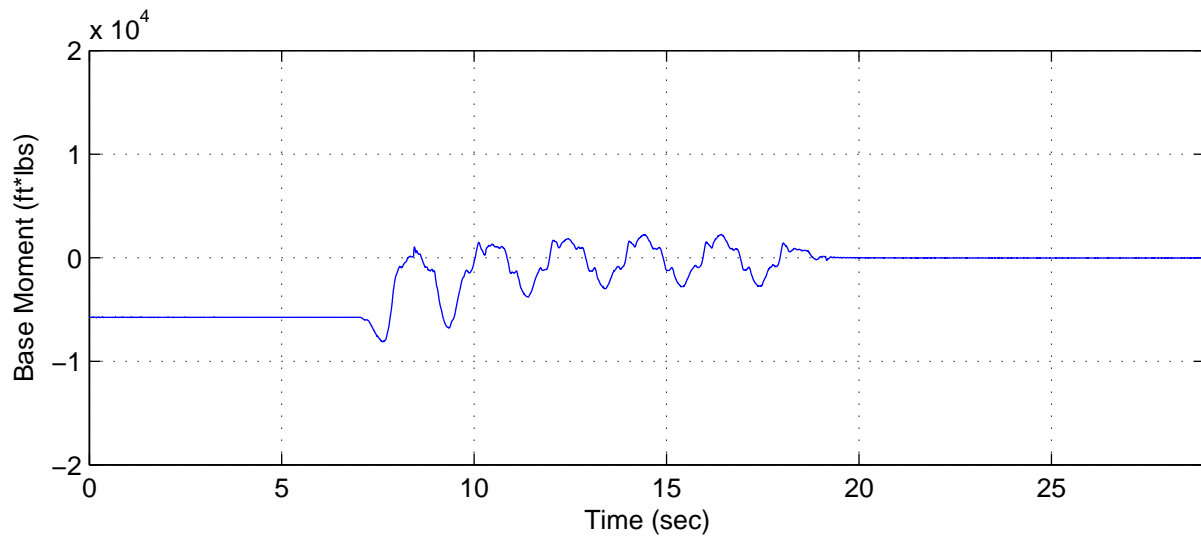
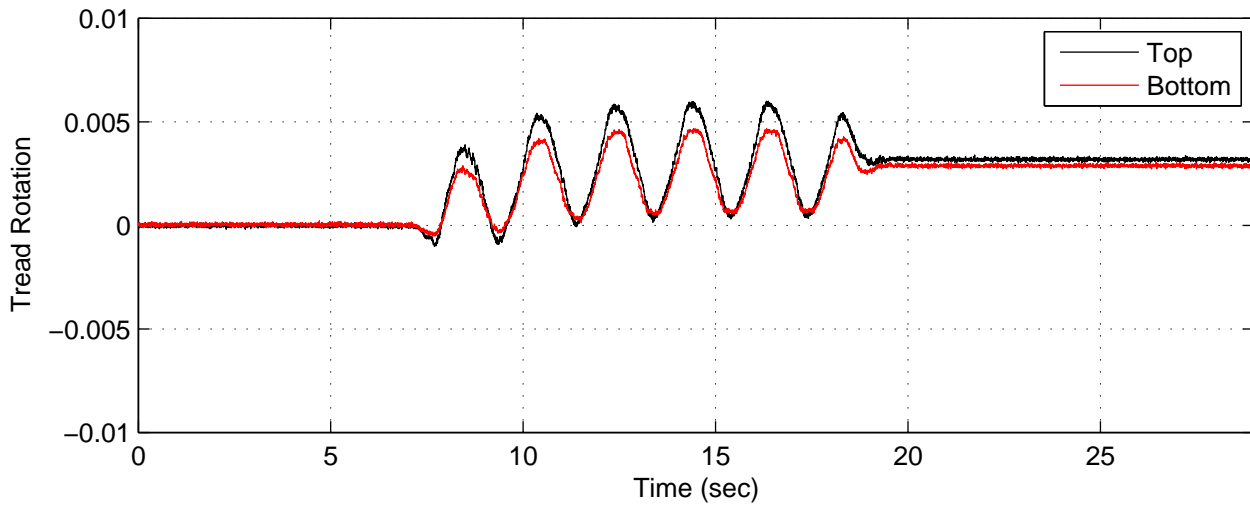
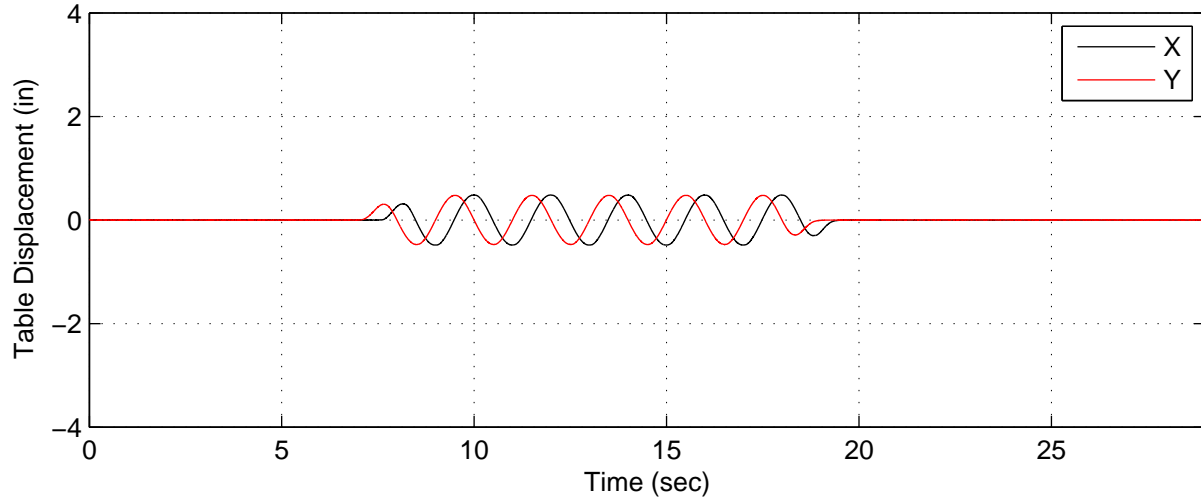

AP4 (Added Mass) – Test J, 2.5in. Dynamic X+Y Disp

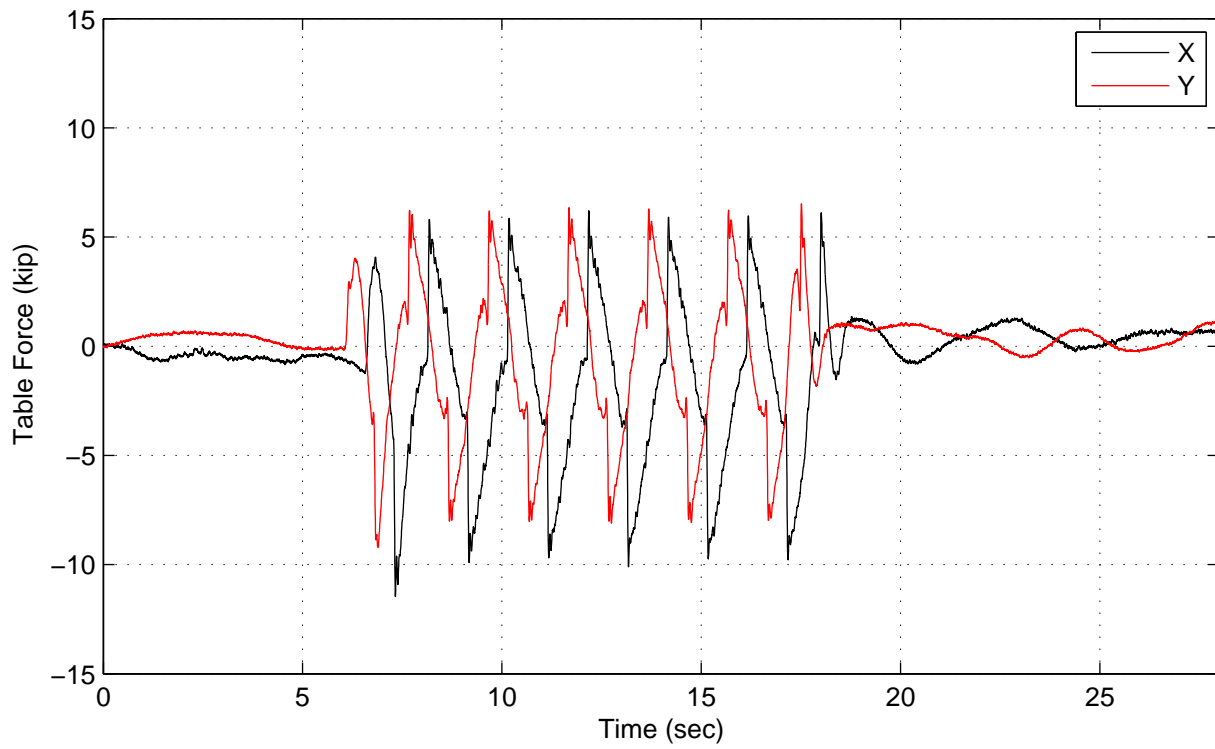
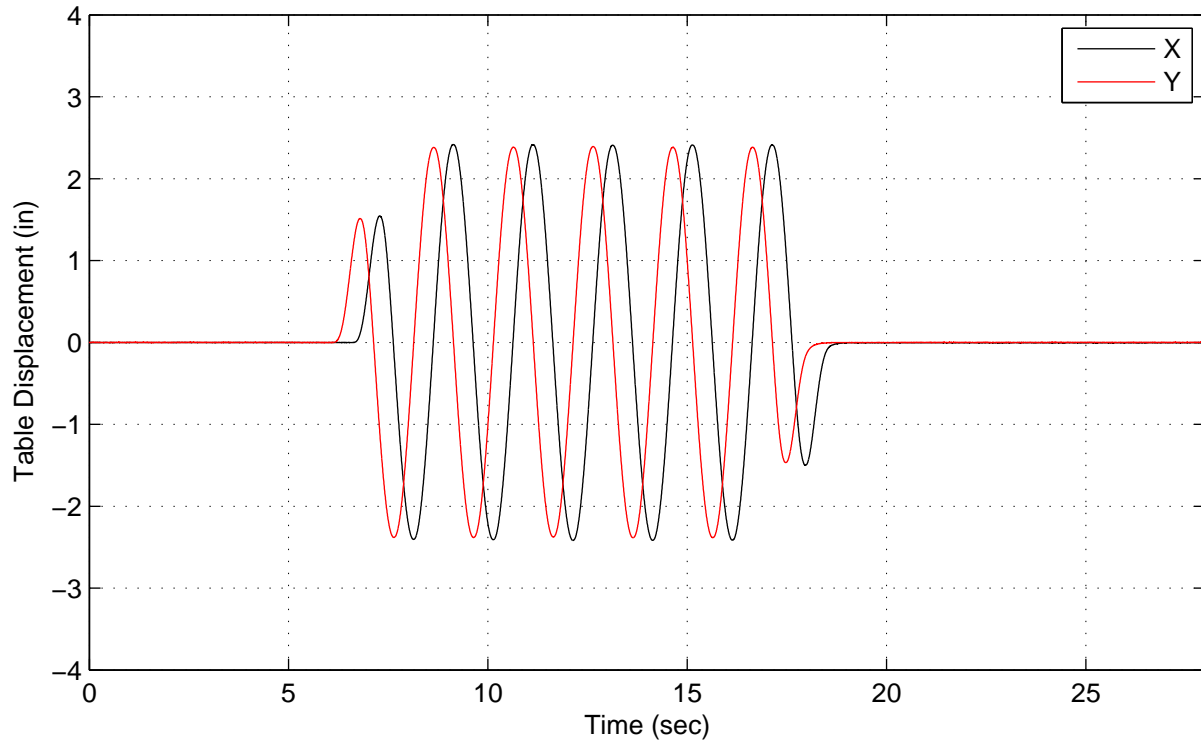

AP4 (Added Mass) – Test J, 2.5in. Dynamic X+Y Disp

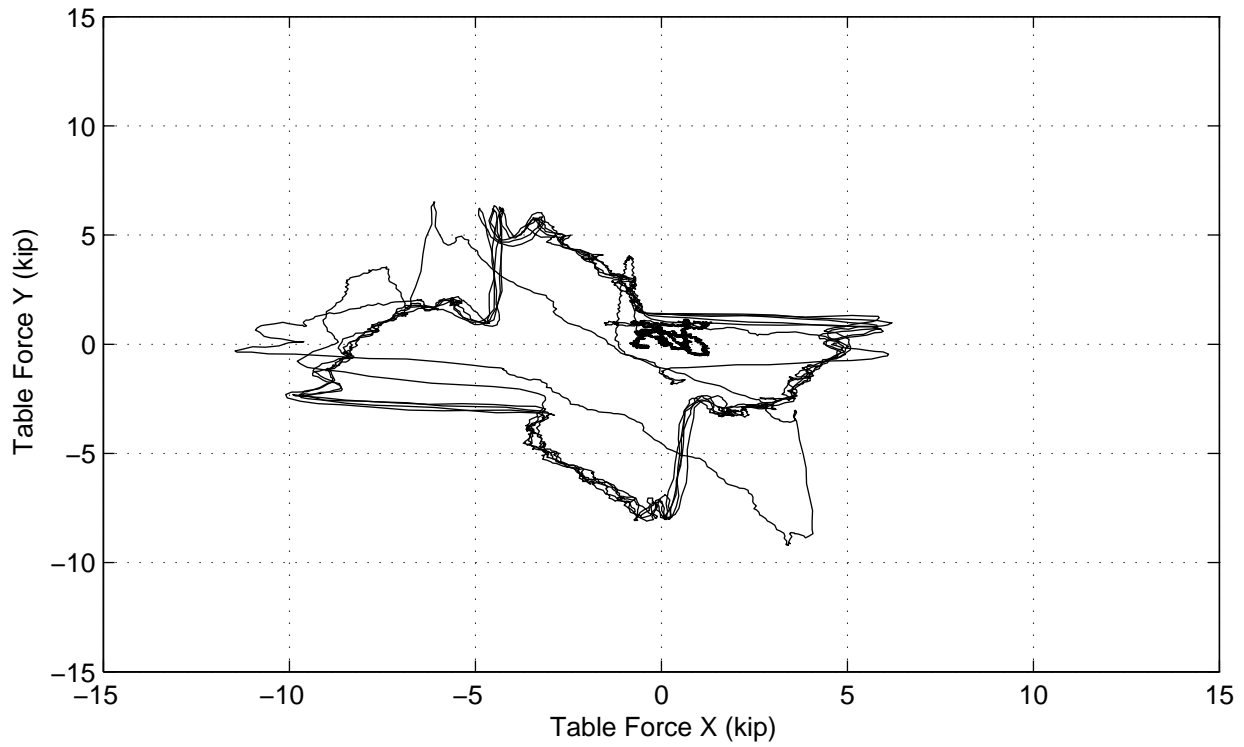
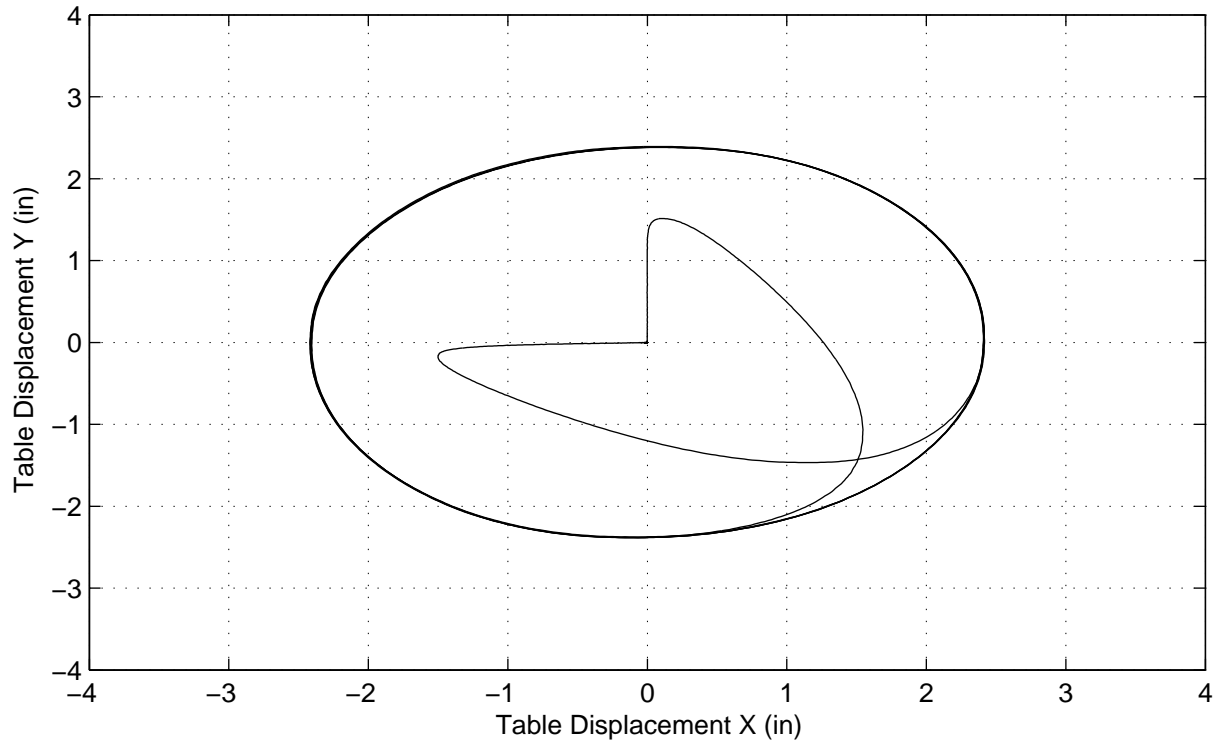



AP4 (Added Mass) – Test J, 2.5in. Dynamic X+Y Disp

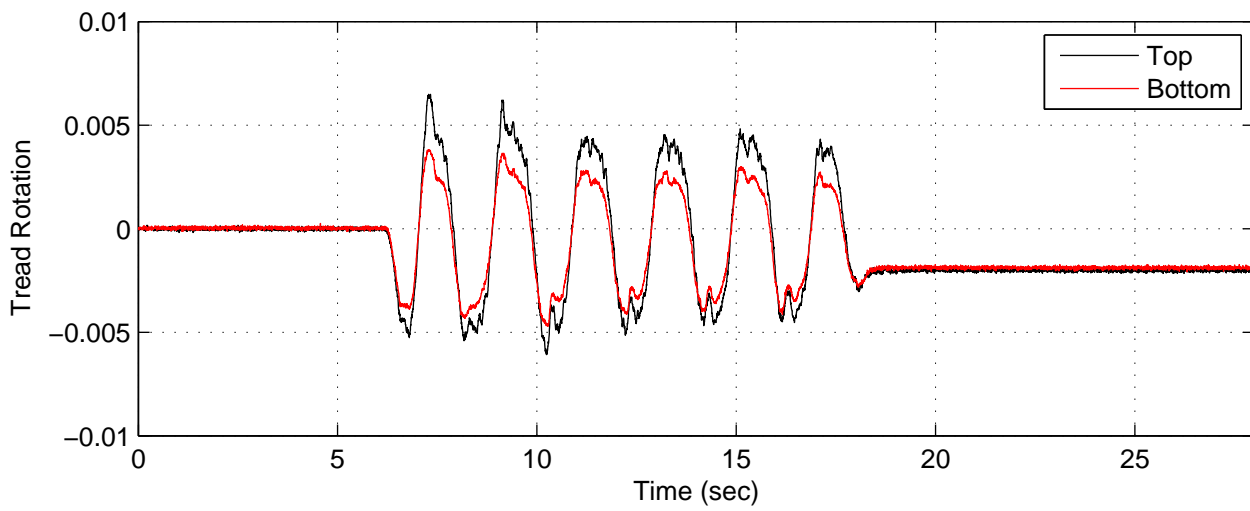
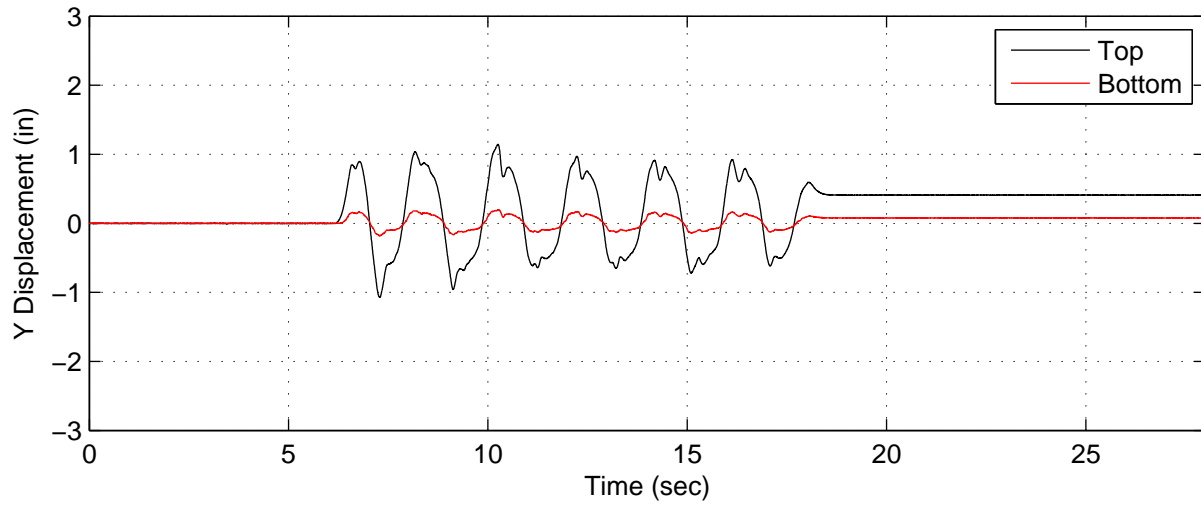
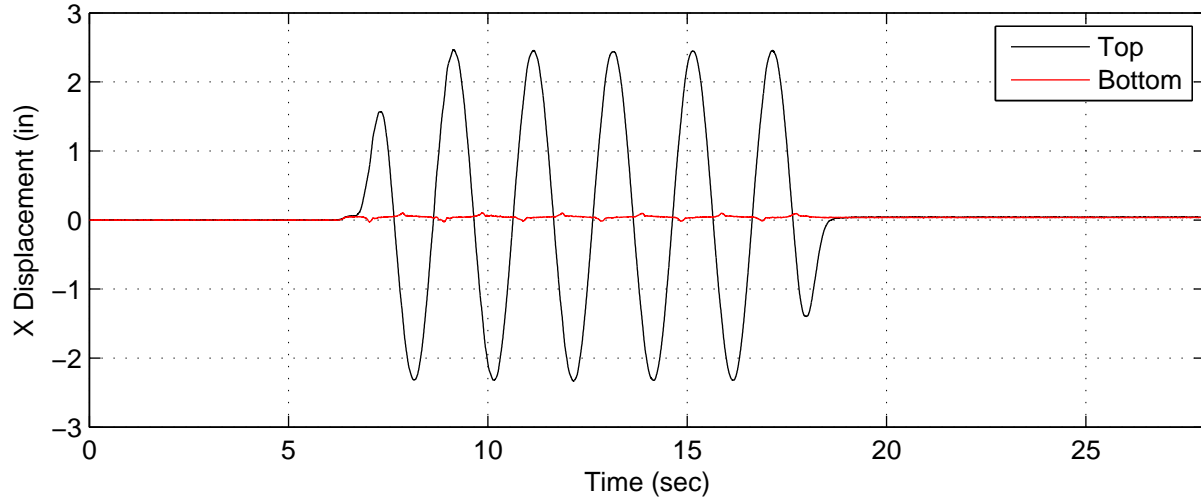

AP4 (Added Mass) – Test J, 2.5in. Dynamic X+Y Disp

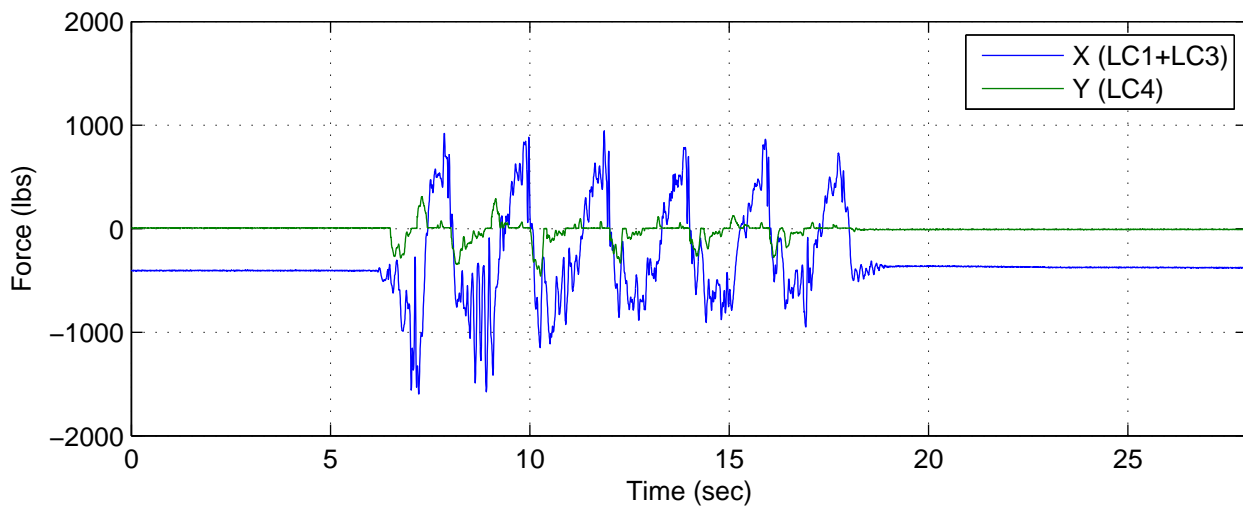
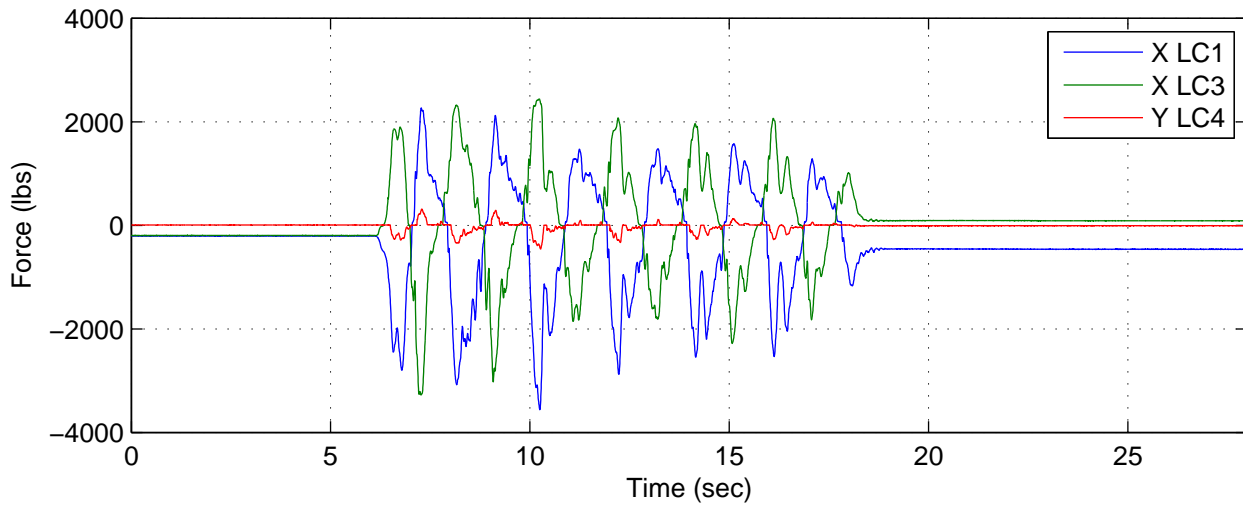
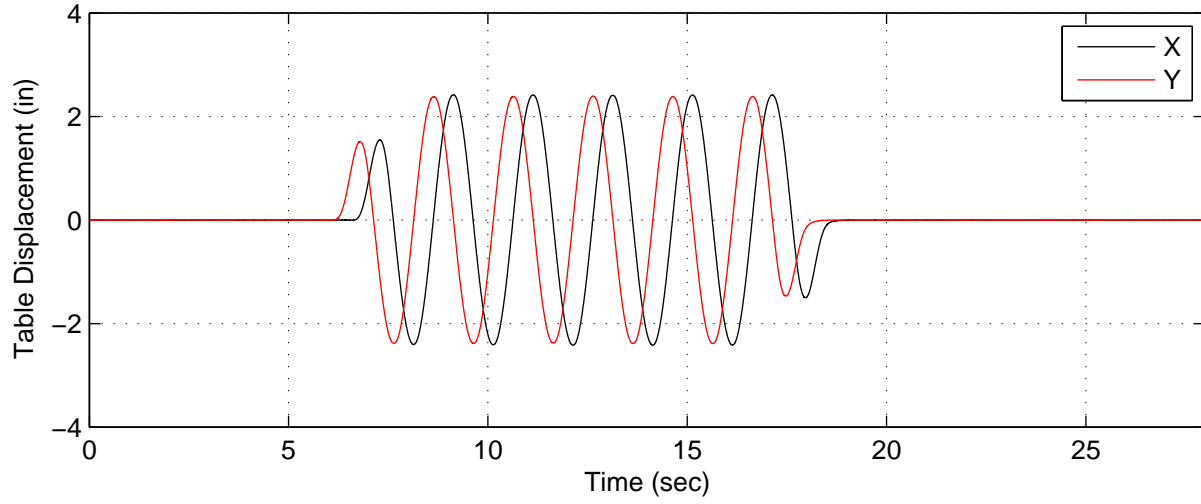

AP4 (Added Mass) – Test J, 2.5in. Dynamic X+Y Disp

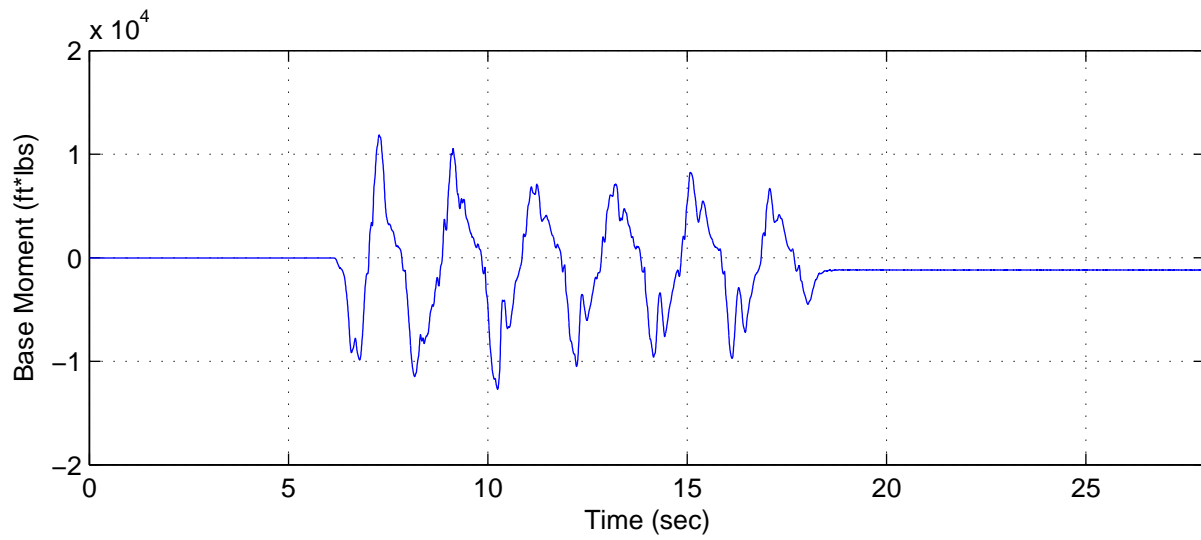
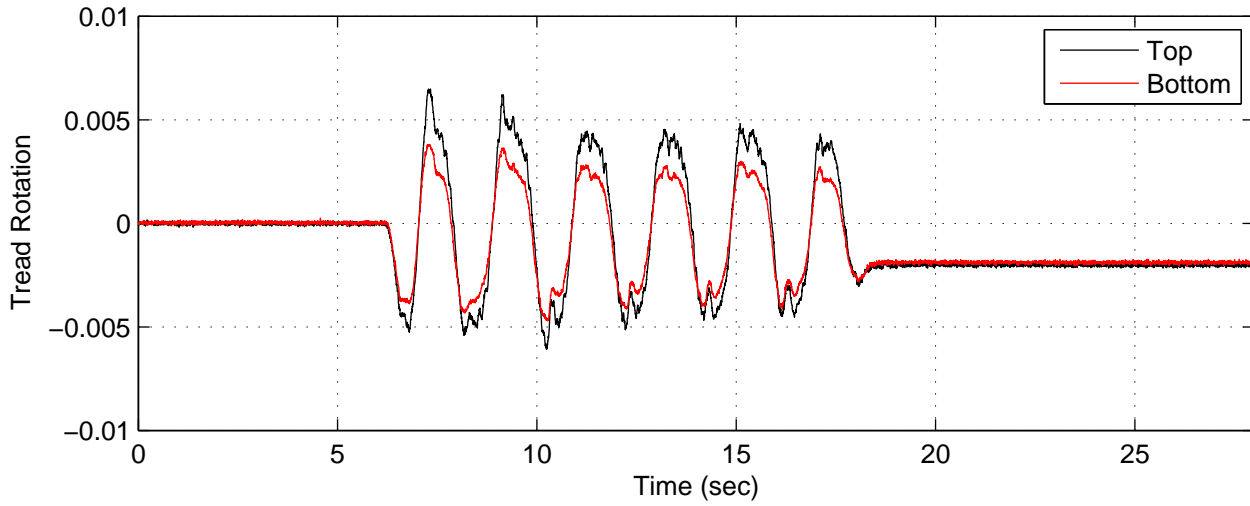
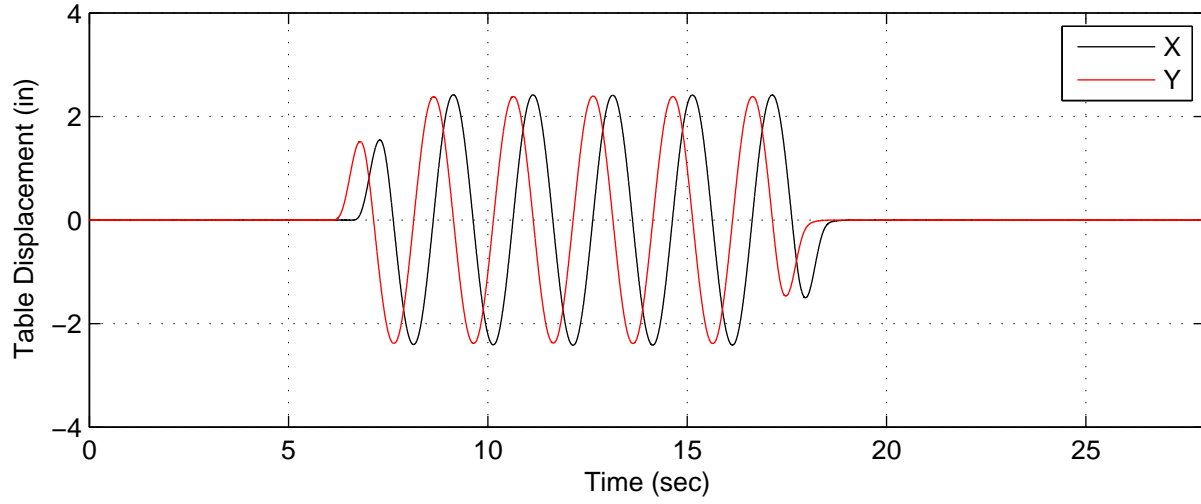

AP4 (Added Mass) – Test K, 3.75in. Dynamic X+Y Disp

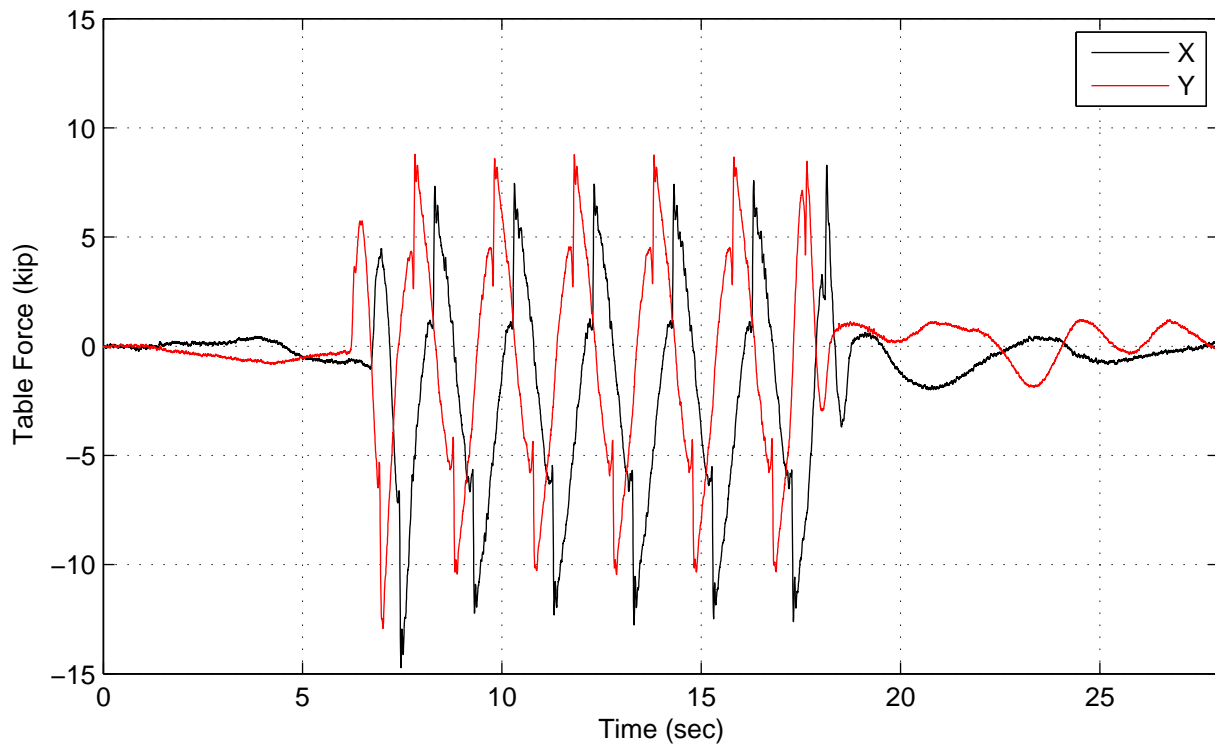
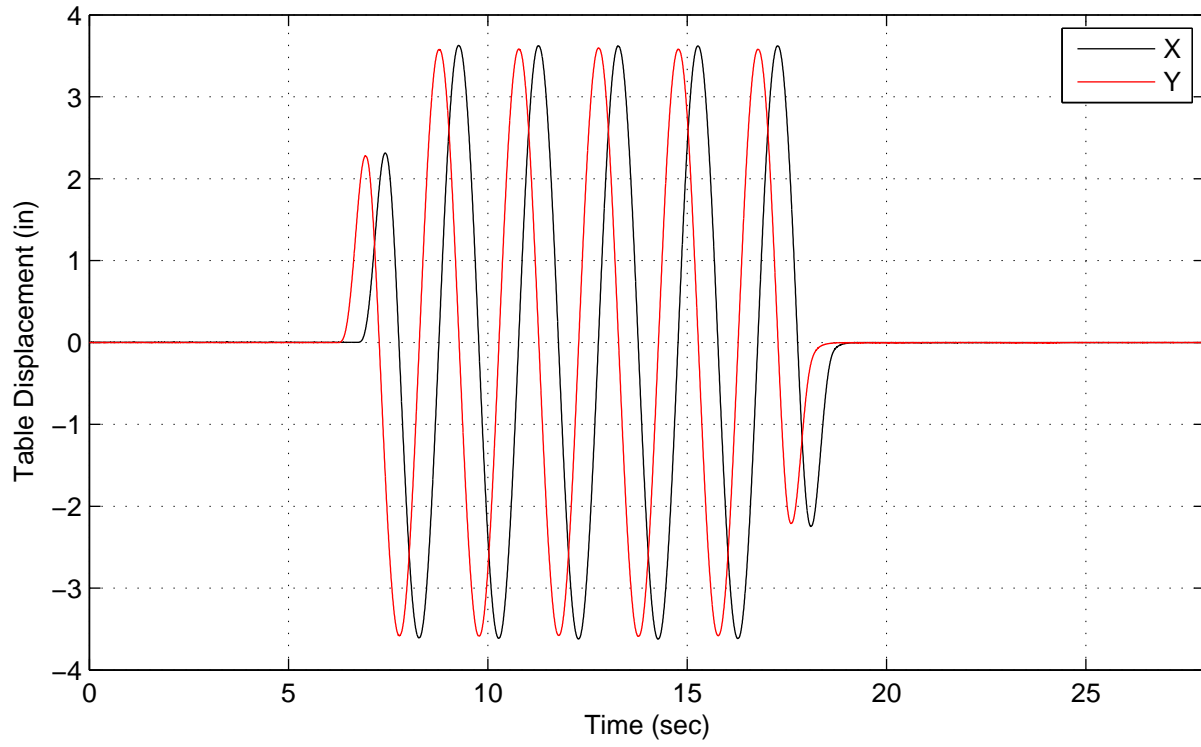

AP4 (Added Mass) – Test K, 3.75in. Dynamic X+Y Disp

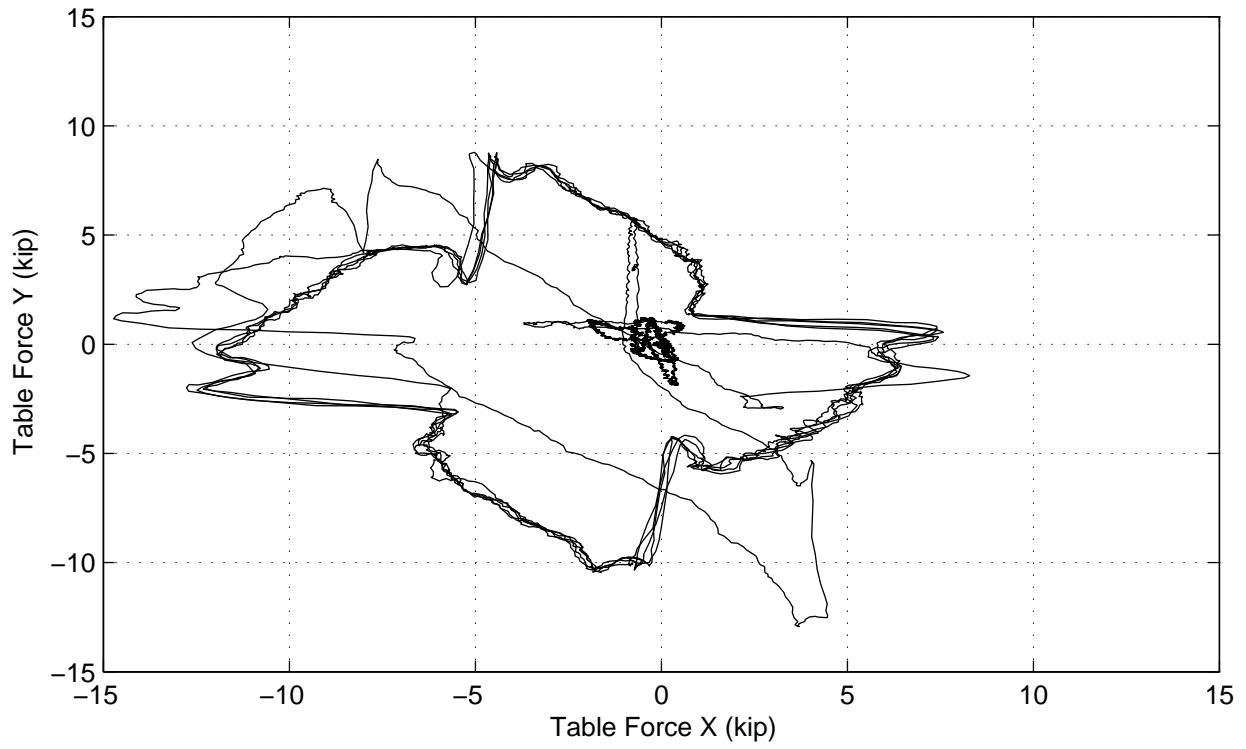
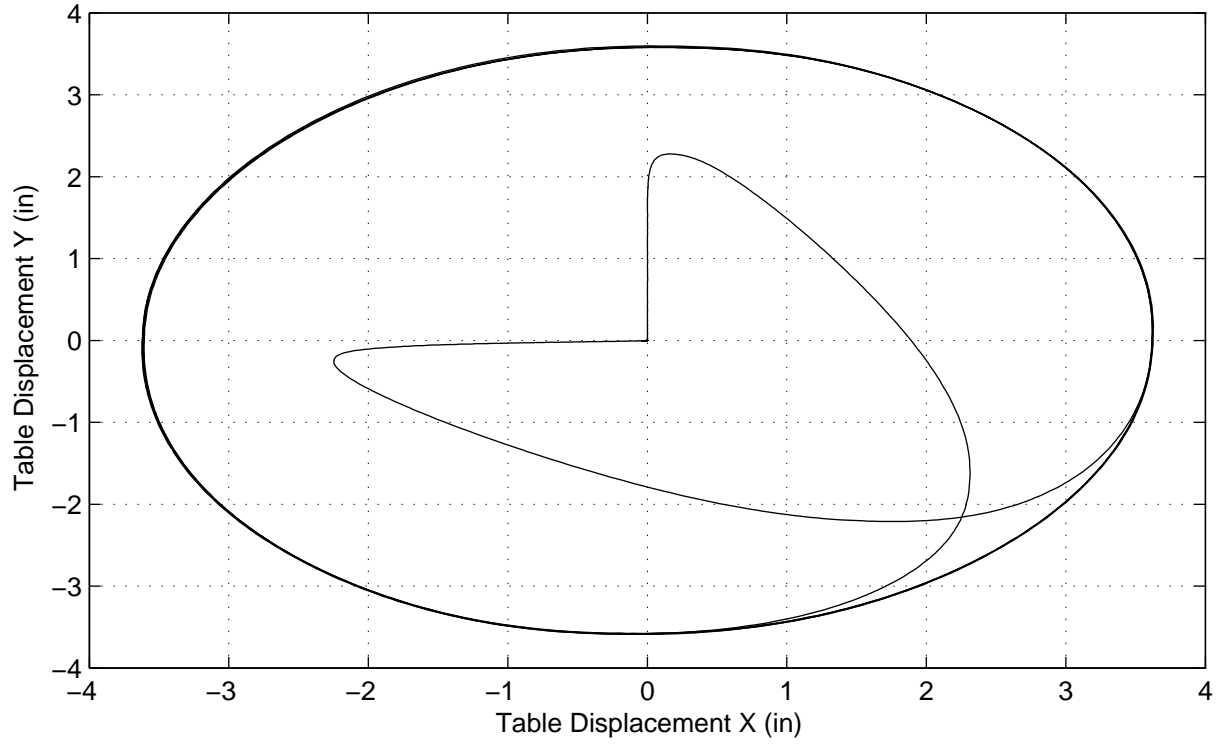

AP4 (Added Mass) – Test K, 3.75in. Dynamic X+Y Disp

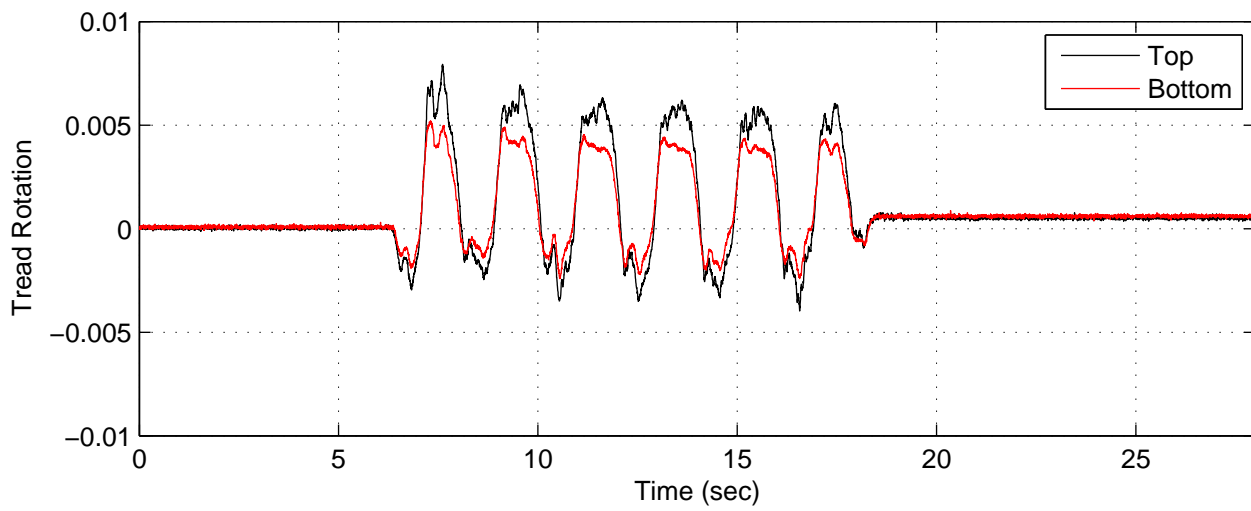
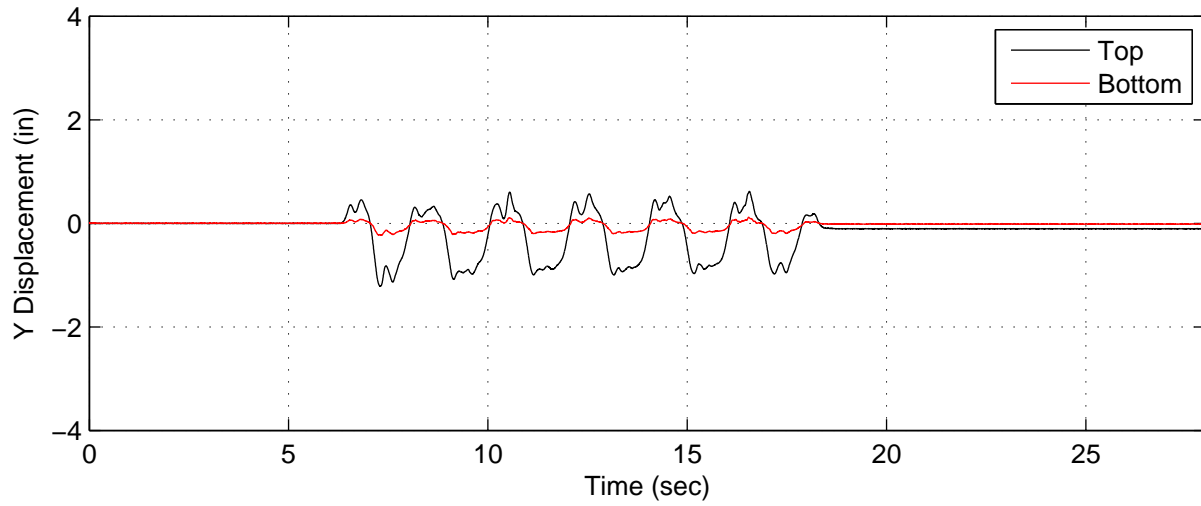
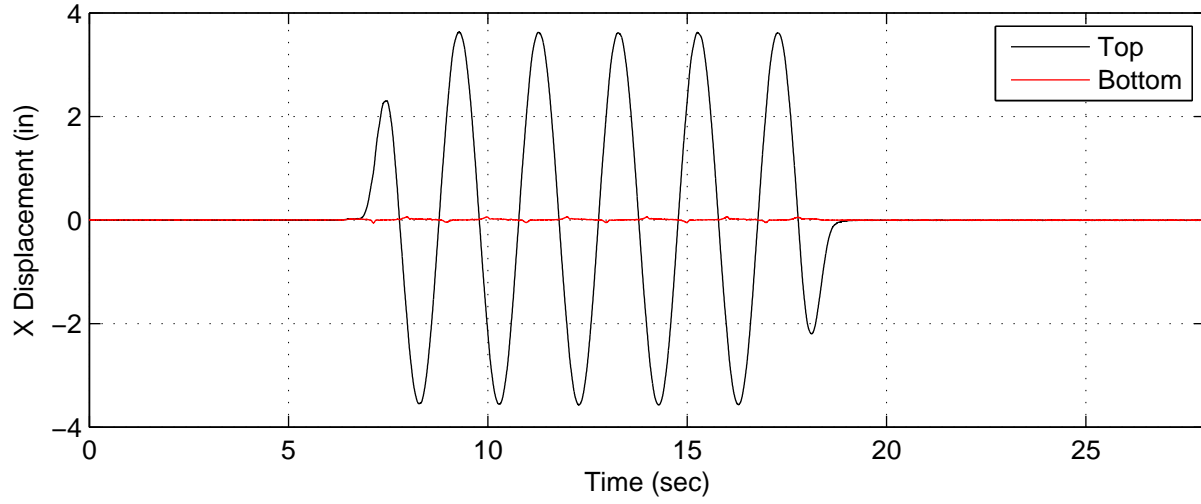

AP4 (Added Mass) – Test K, 3.75in. Dynamic X+Y Disp

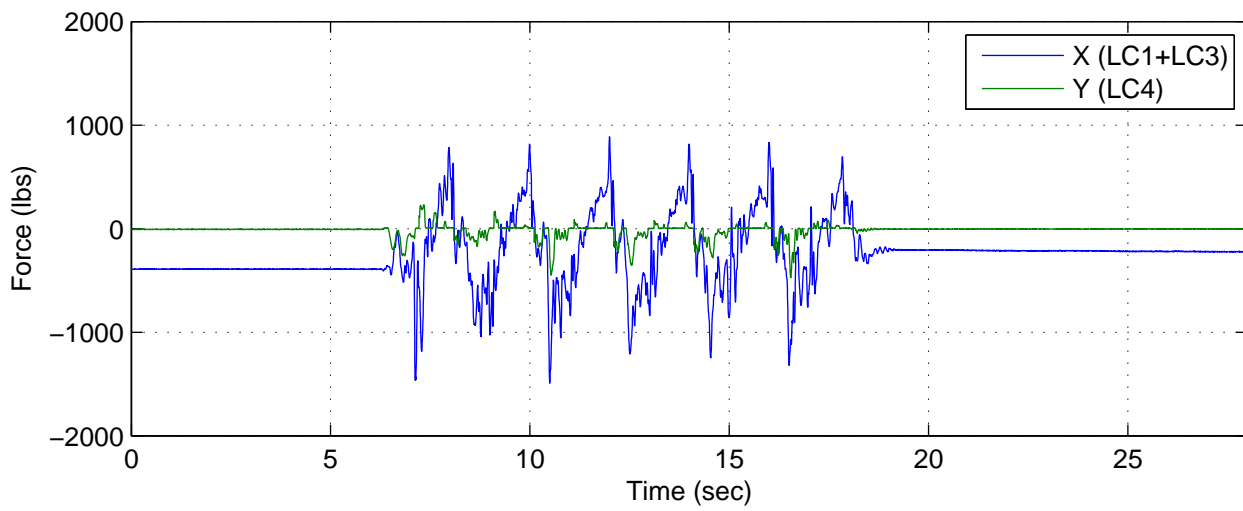
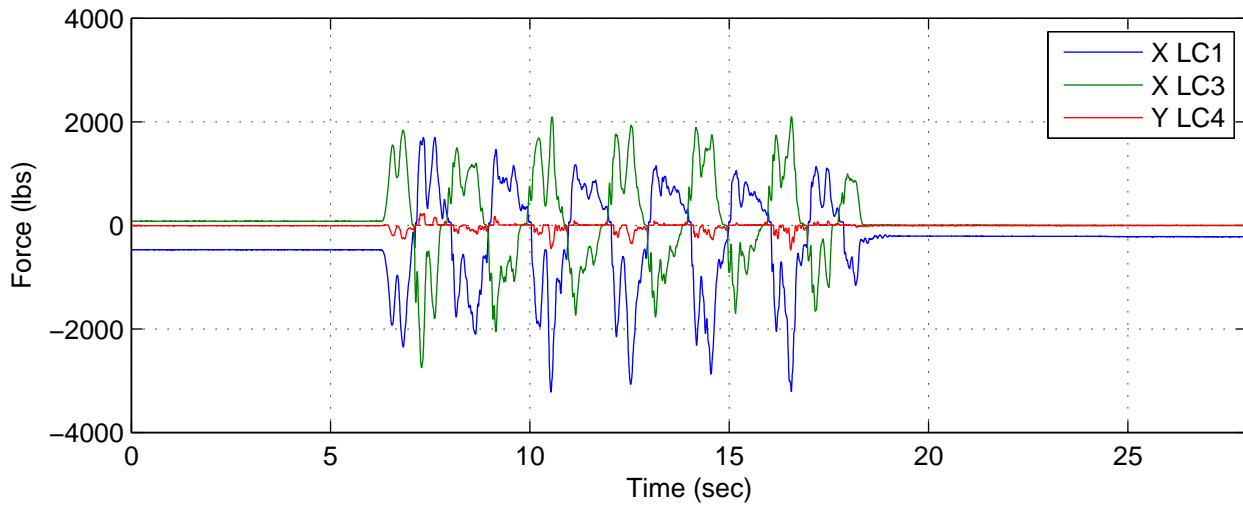
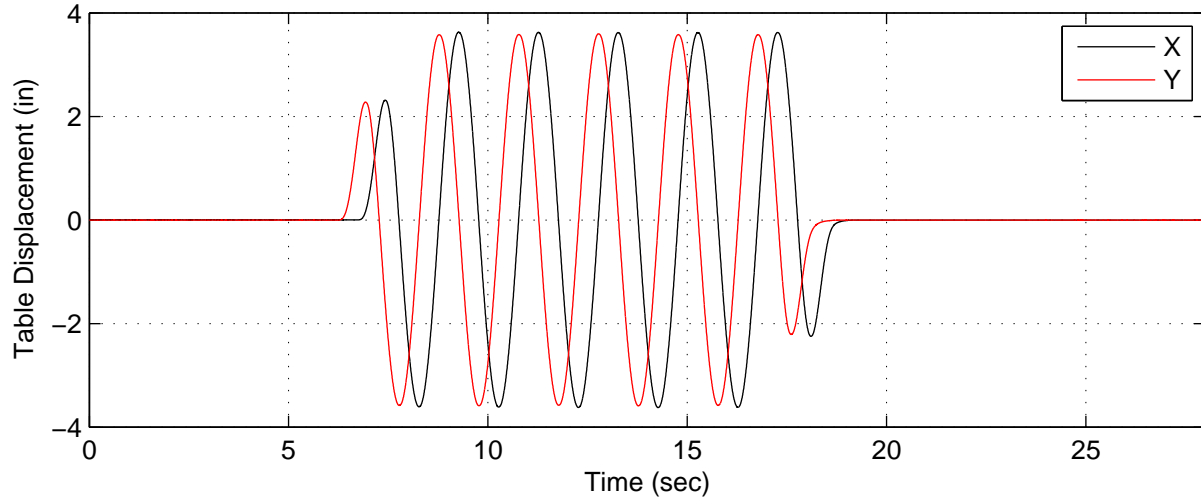

AP4 (Added Mass) – Test K, 3.75in. Dynamic X+Y Disp

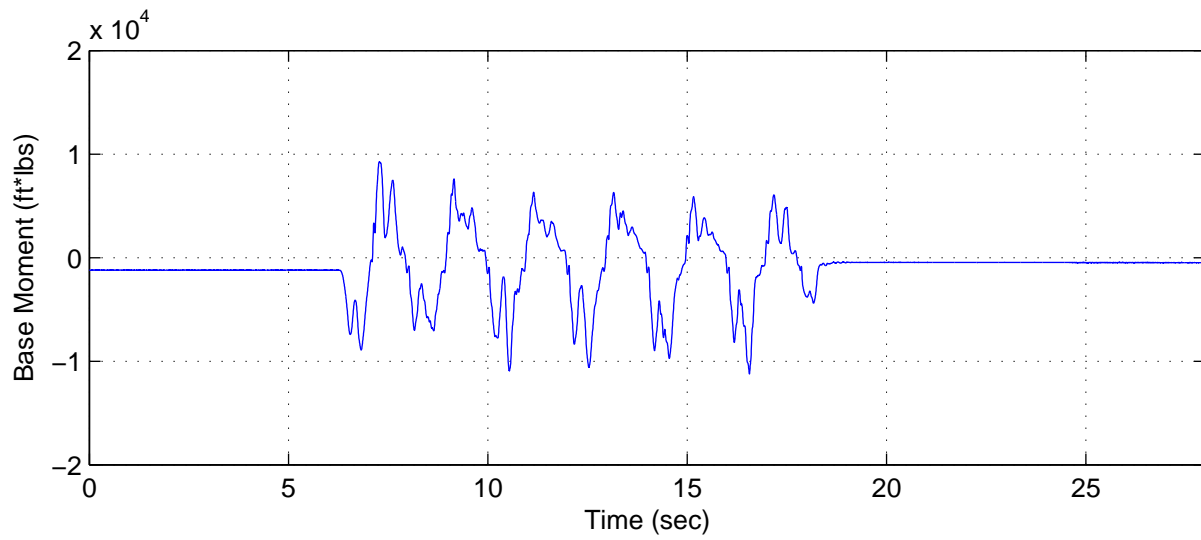
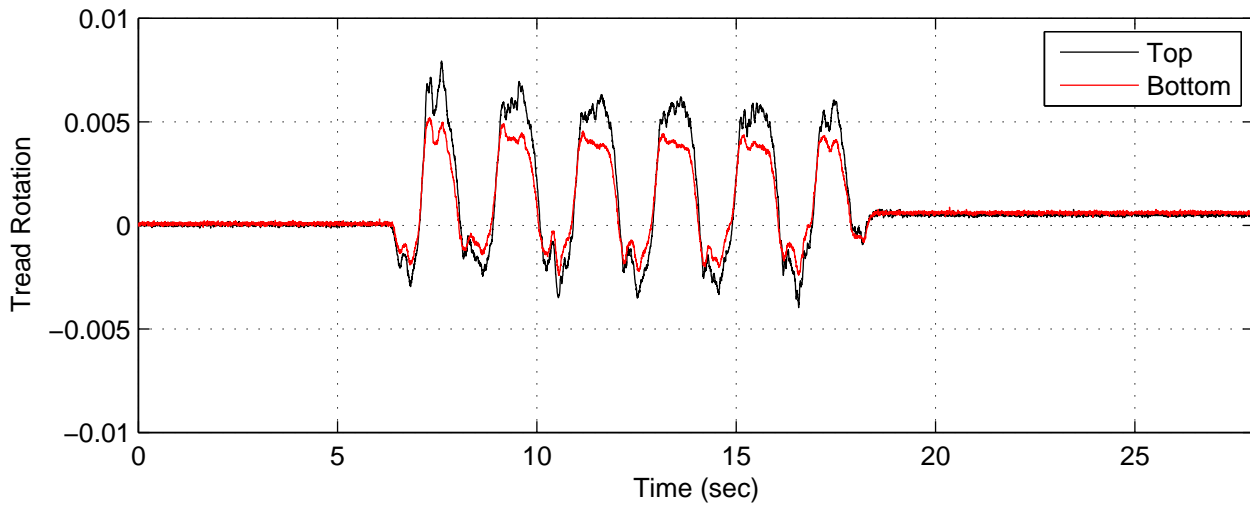
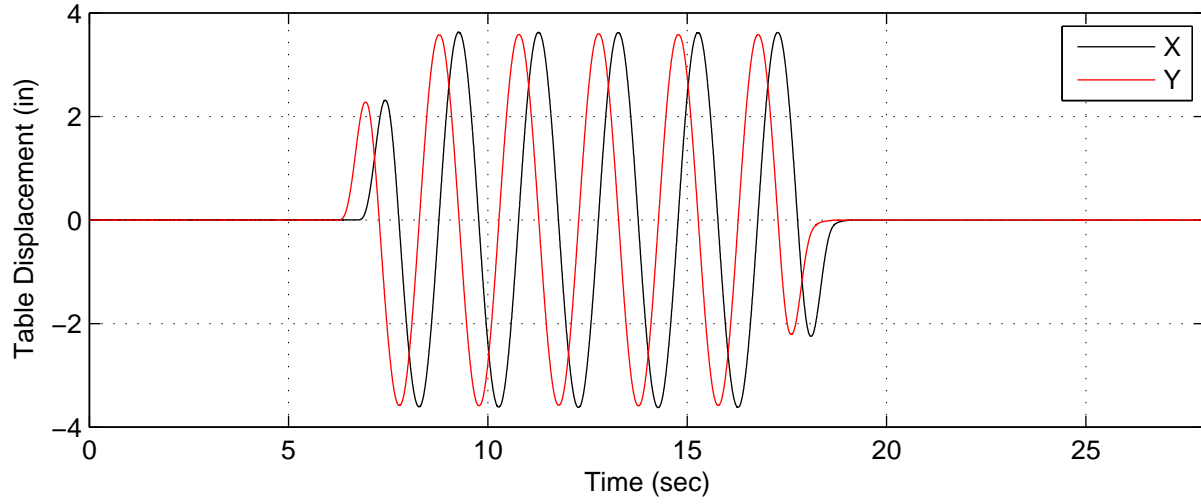



AP4 (Added Mass) – Test L, 2.5in. Long Period DBE – 0 deg Long

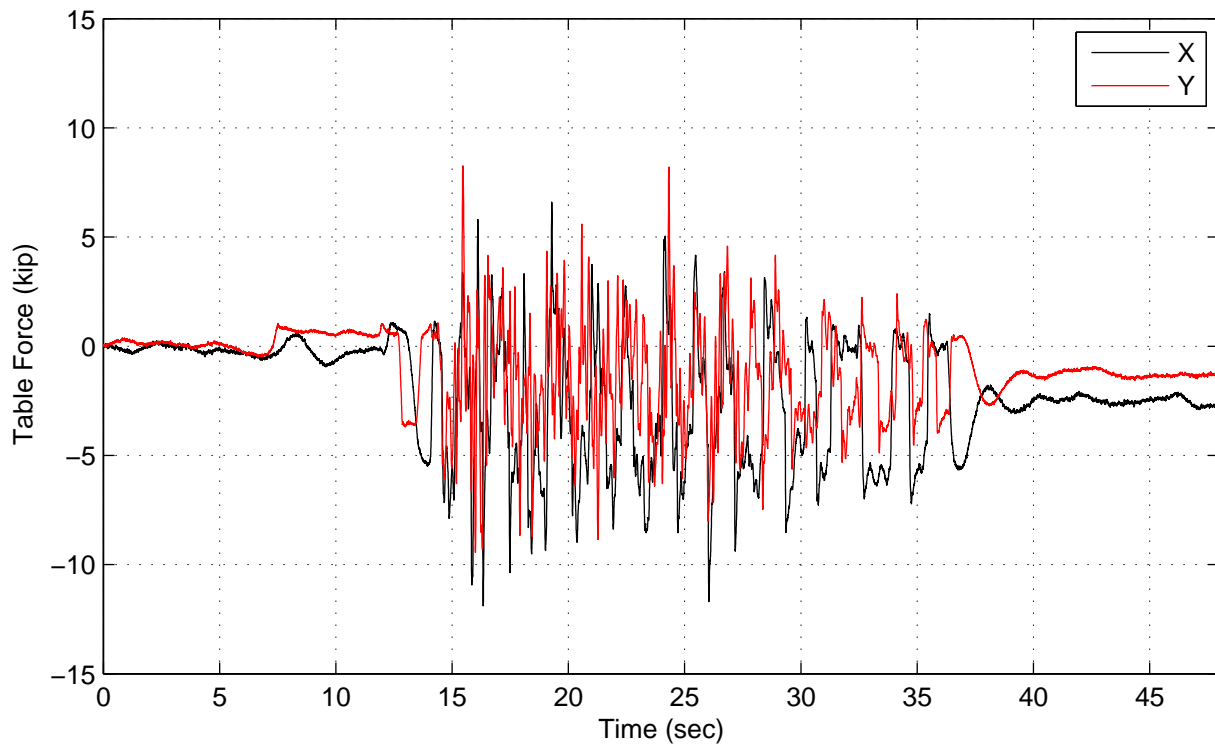
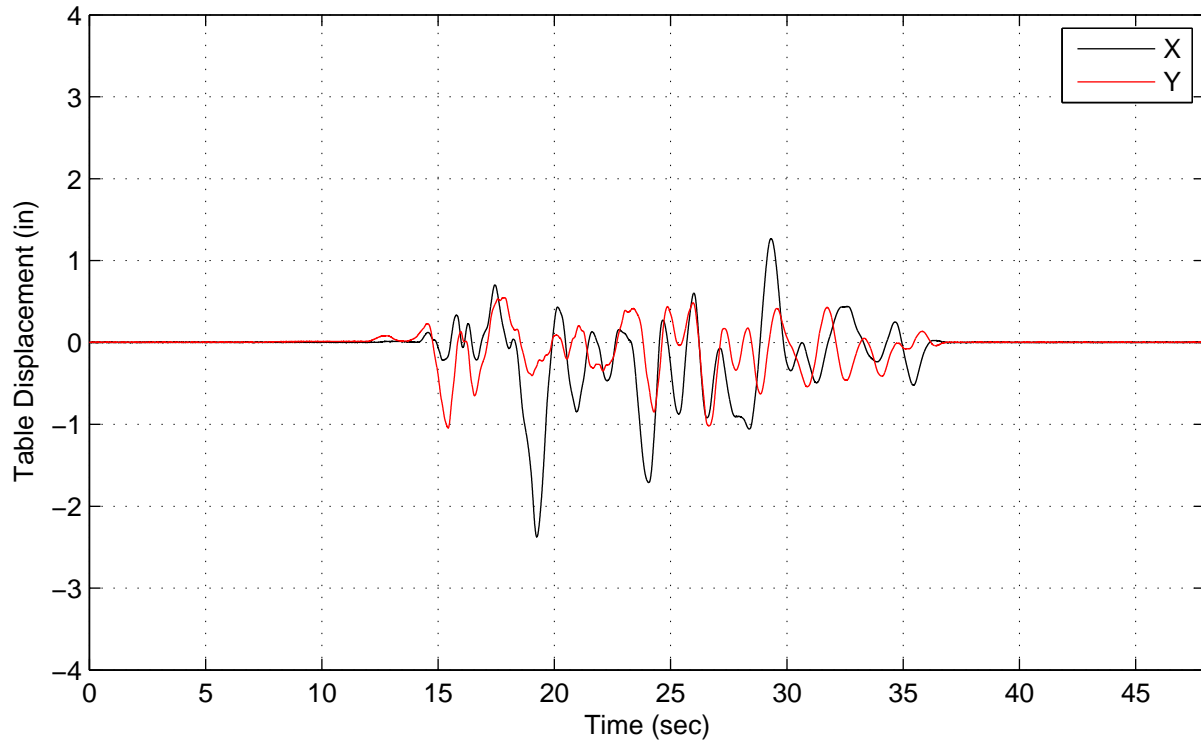

AP4 (Added Mass) – Test L, 2.5in. Long Period DBE – 0 deg Long

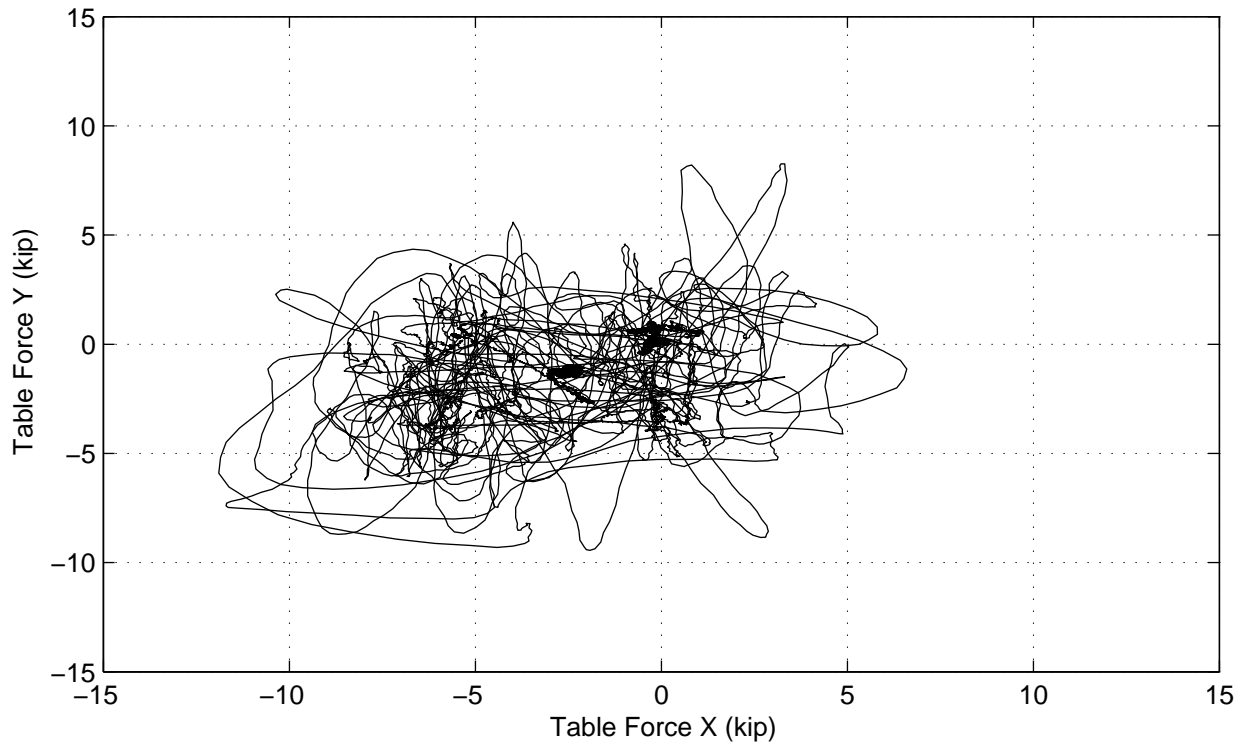
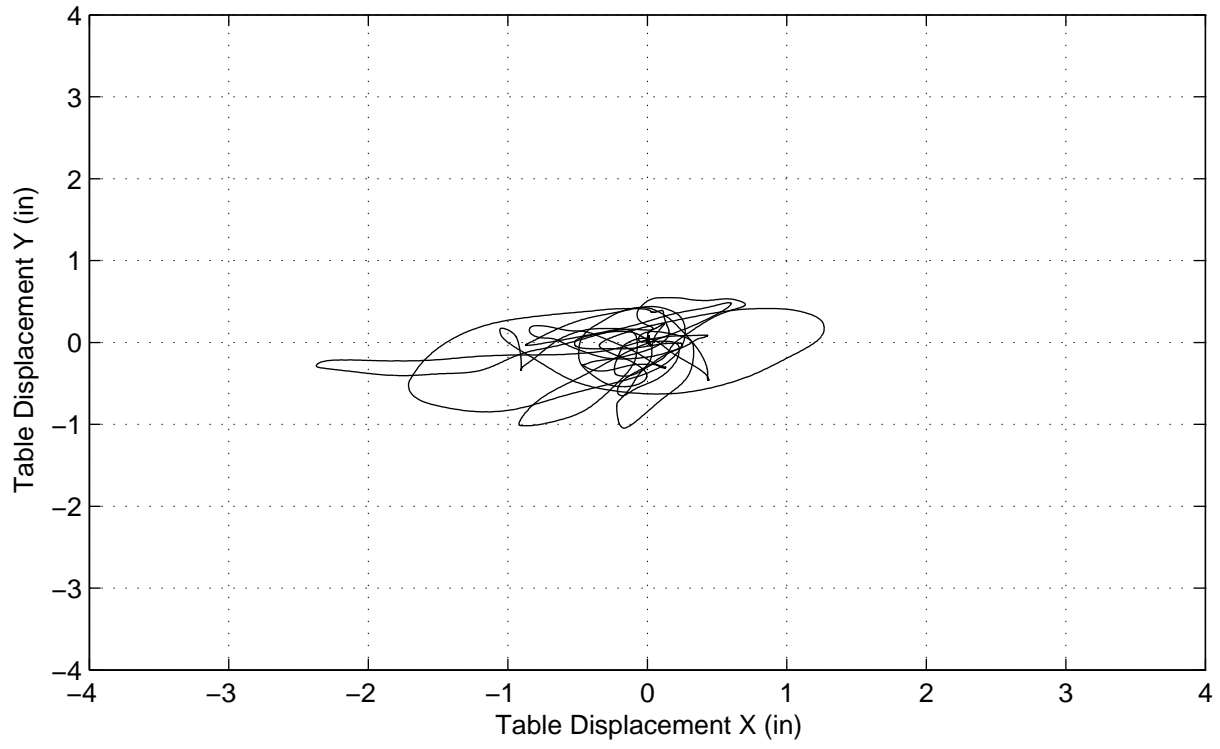

AP4 (Added Mass) – Test L, 2.5in. Long Period DBE – 0 deg Long

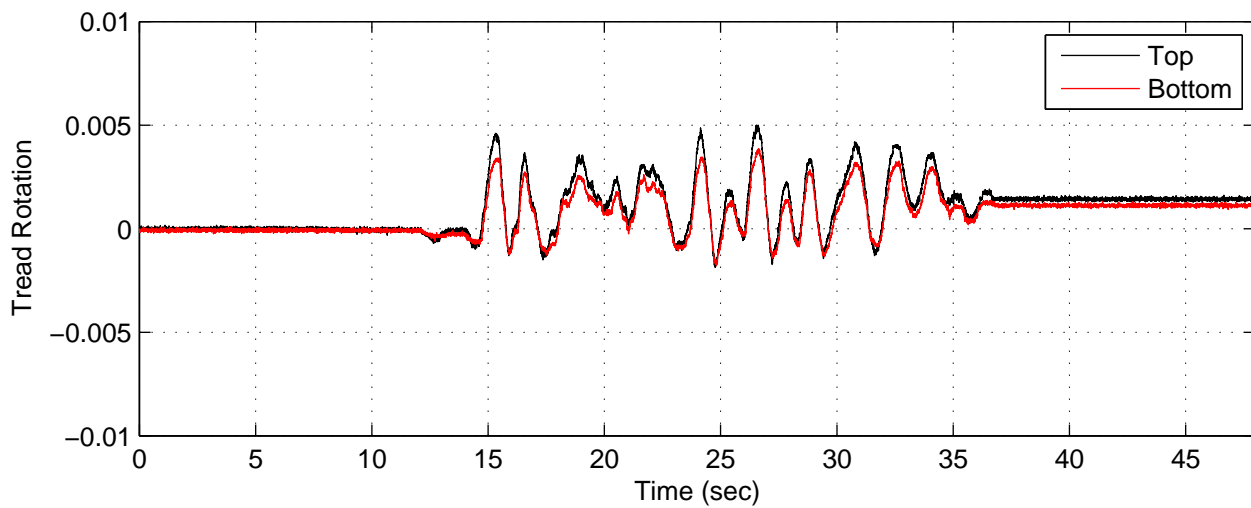
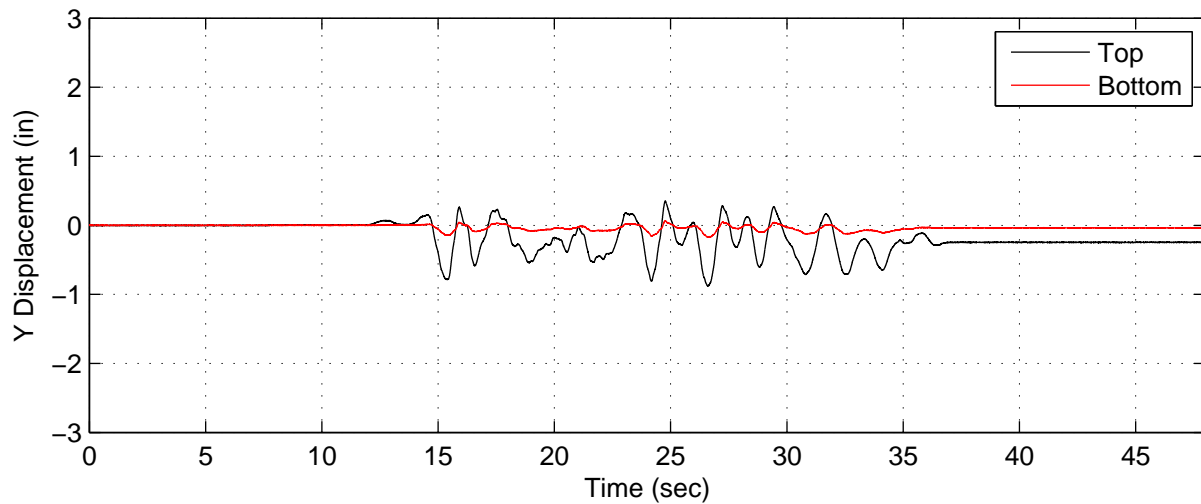
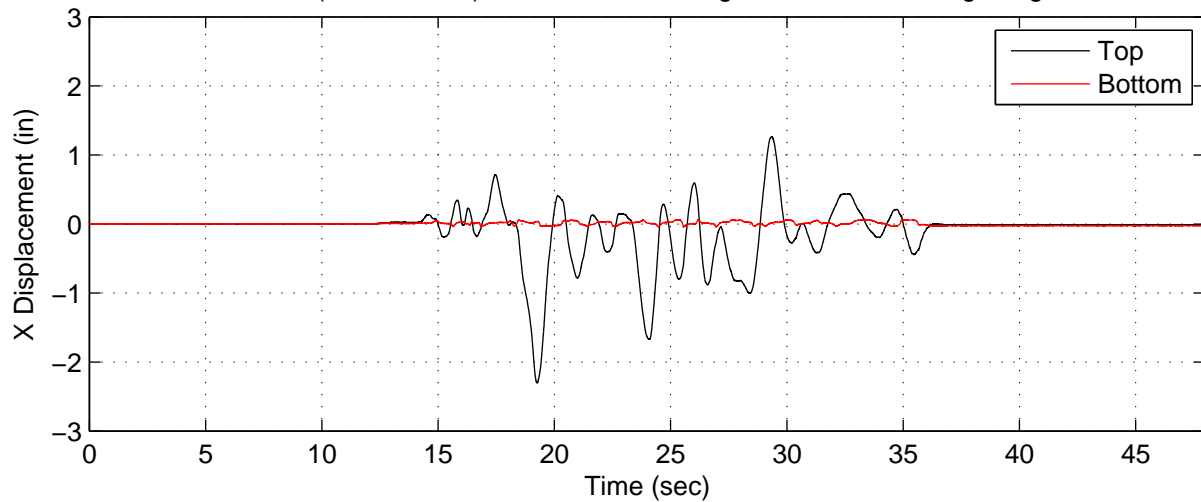

AP4 (Added Mass) – Test L, 2.5in. Long Period DBE – 0 deg Long

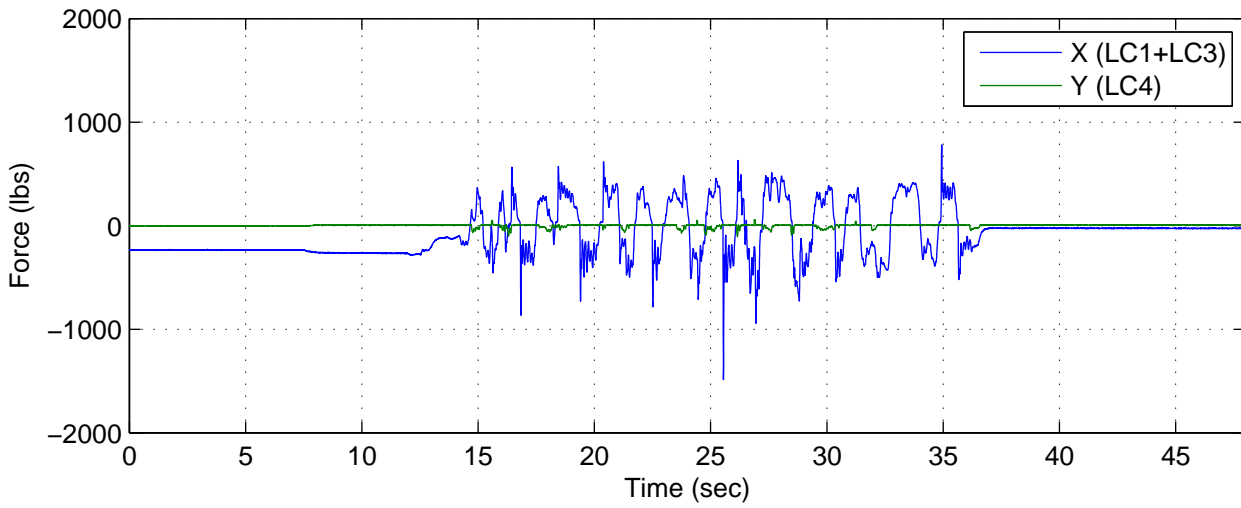
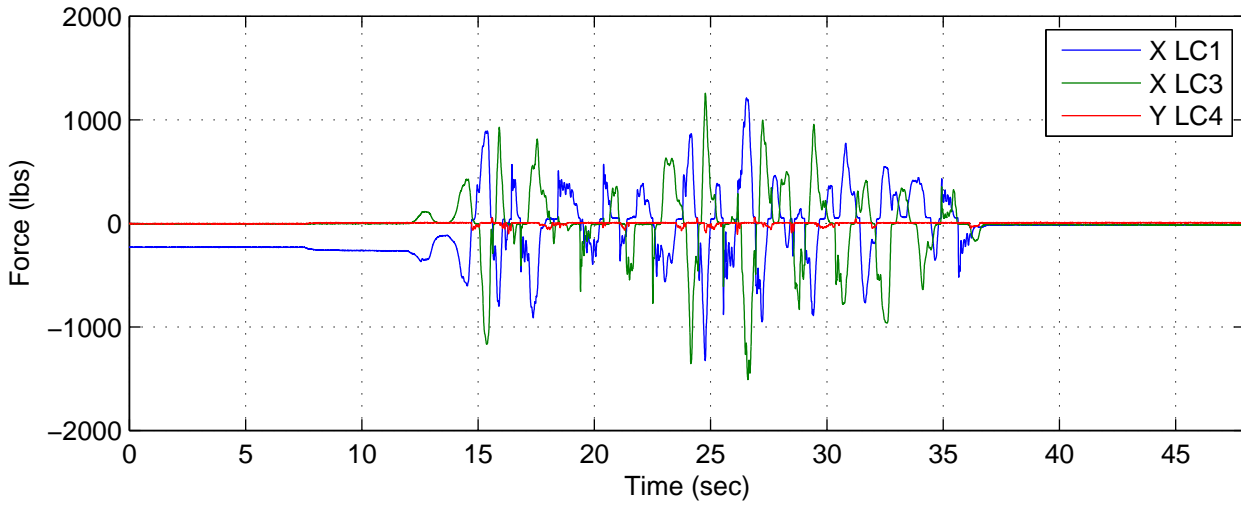
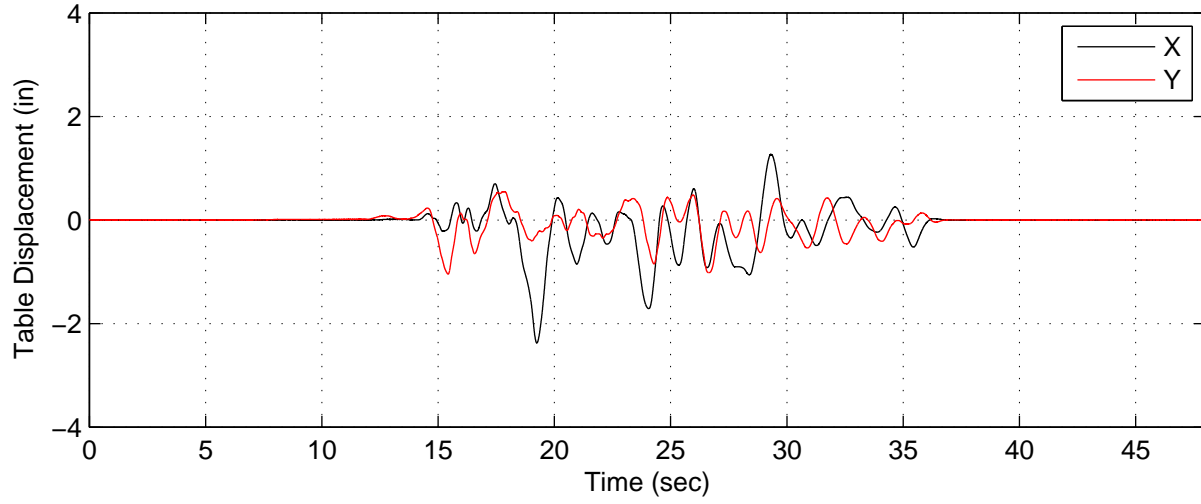

AP4 (Added Mass) – Test L, 2.5in. Long Period DBE – 0 deg Long

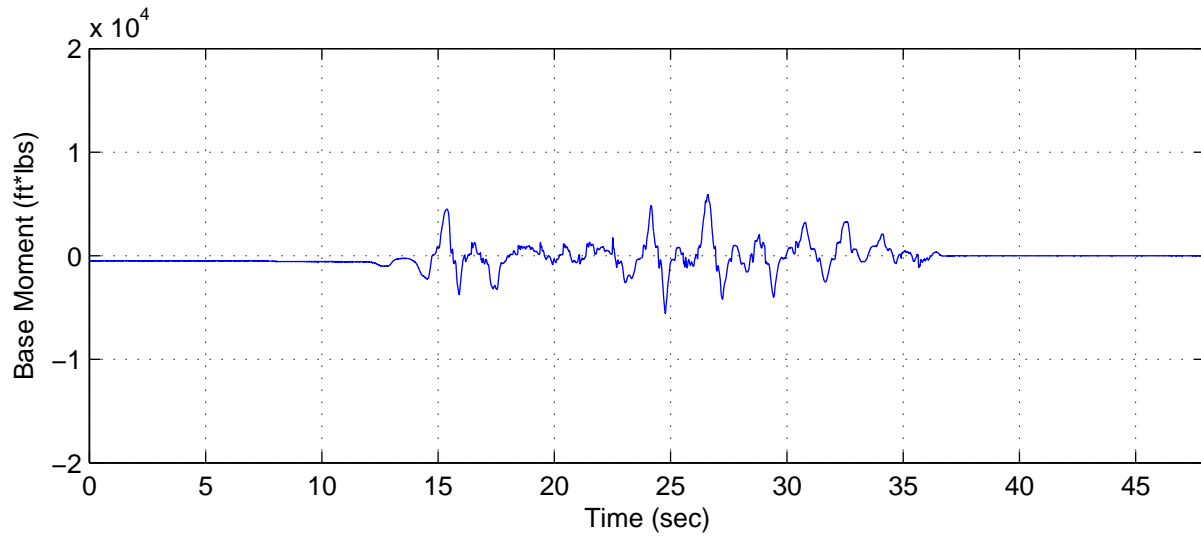
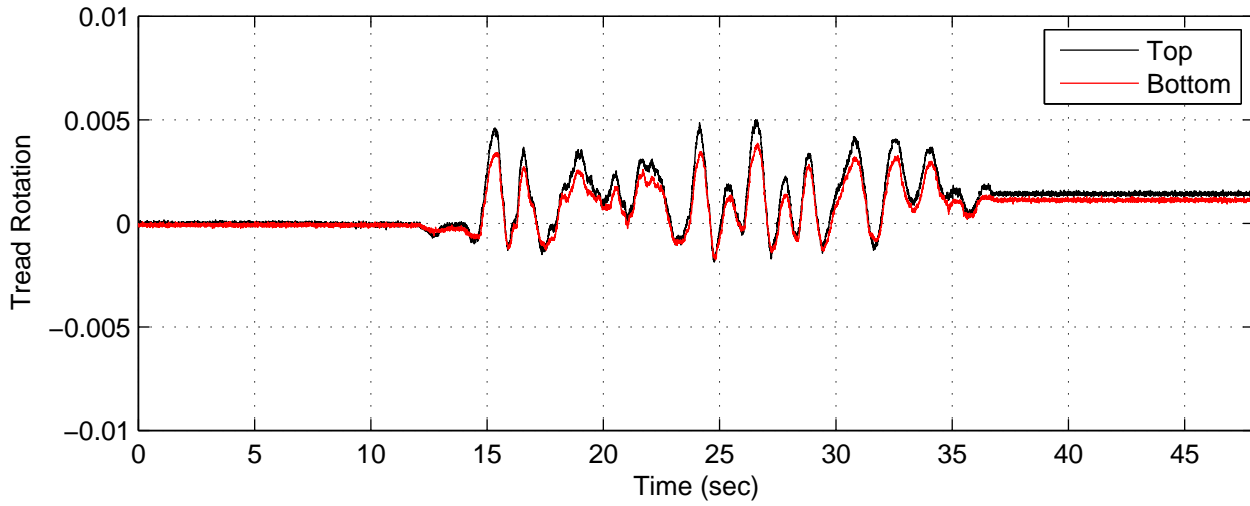
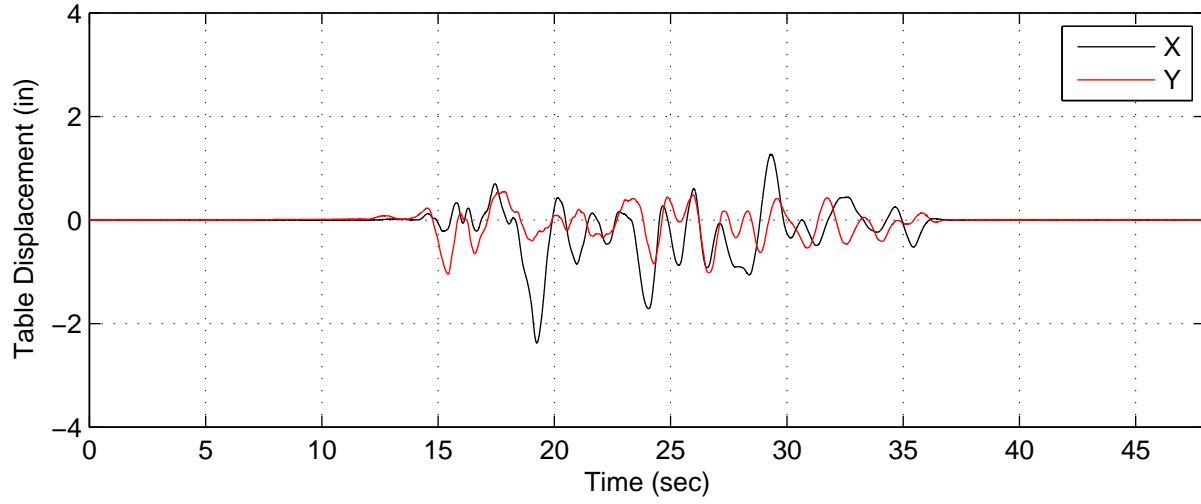

AP4 (Added Mass) – Test M, 2.5in. Long Period DBE – 0 deg Trans

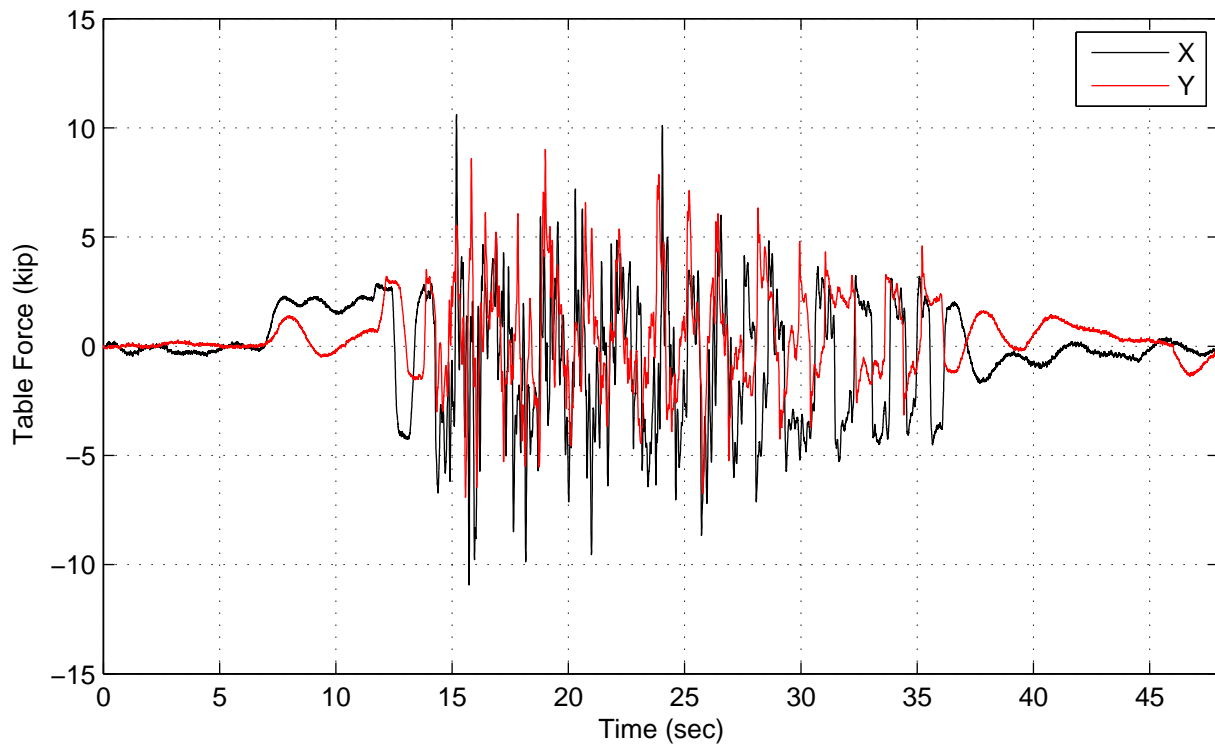
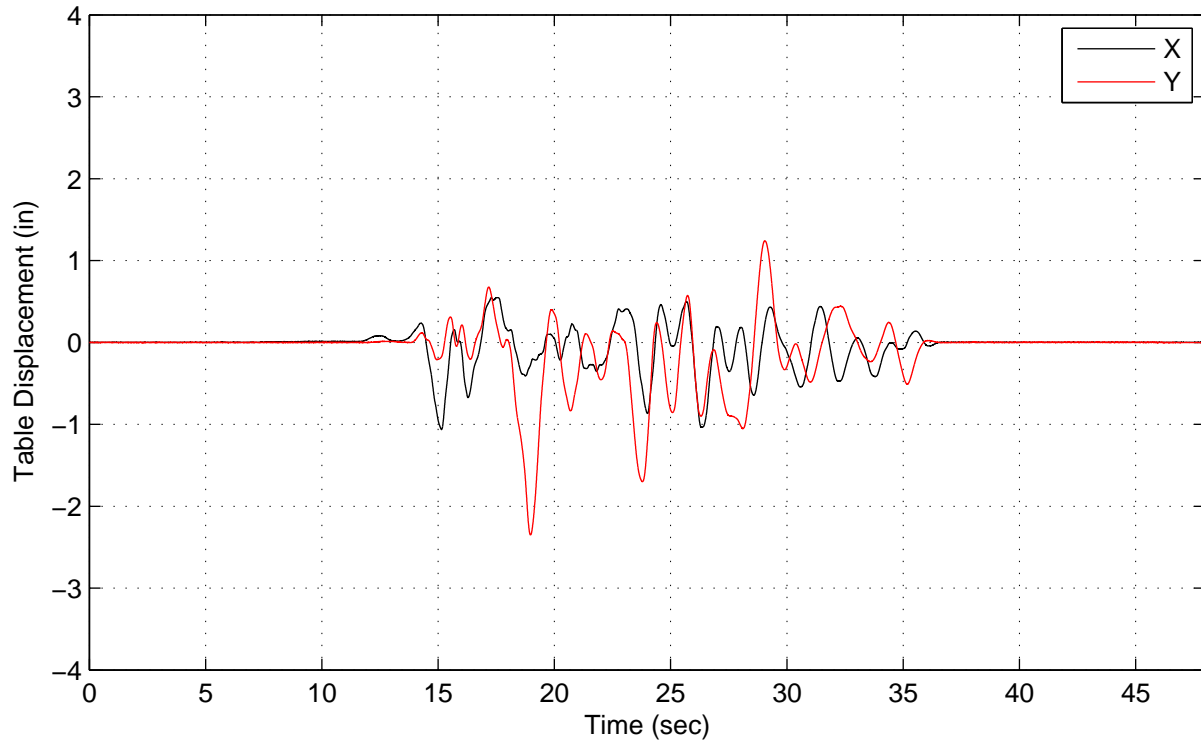

AP4 (Added Mass) – Test M, 2.5in. Long Period DBE – 0 deg Trans

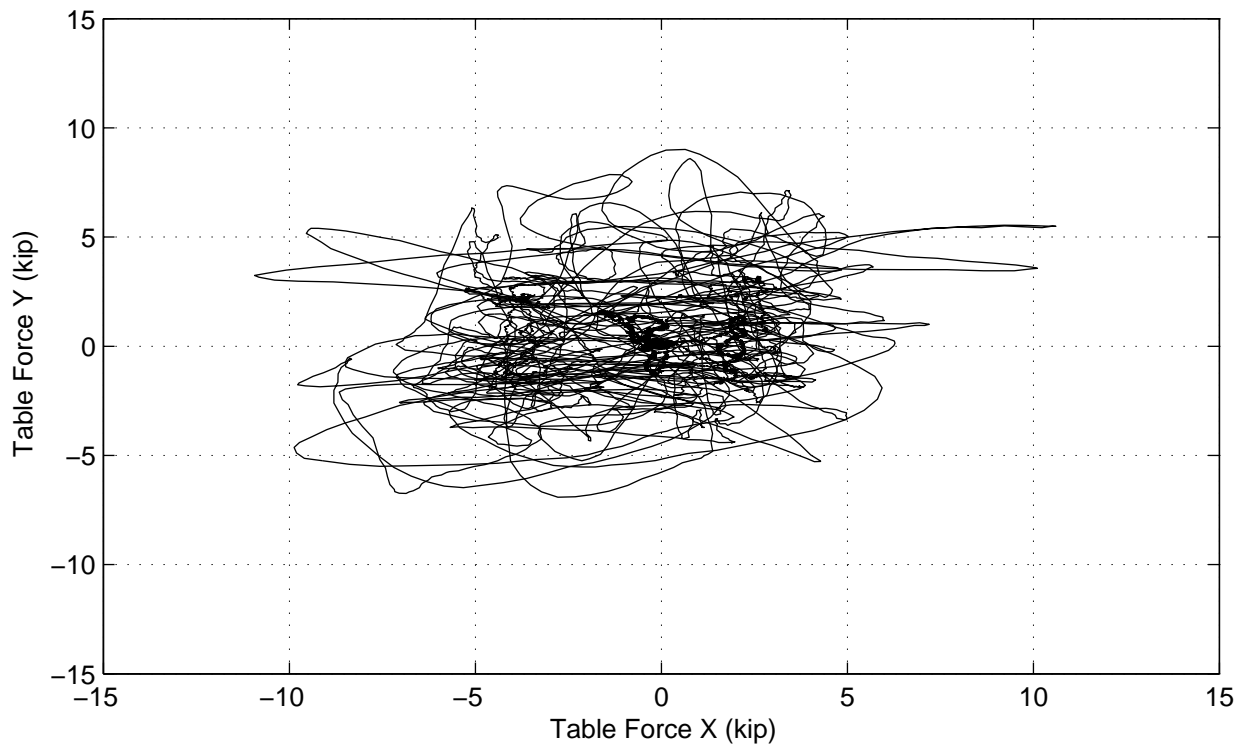
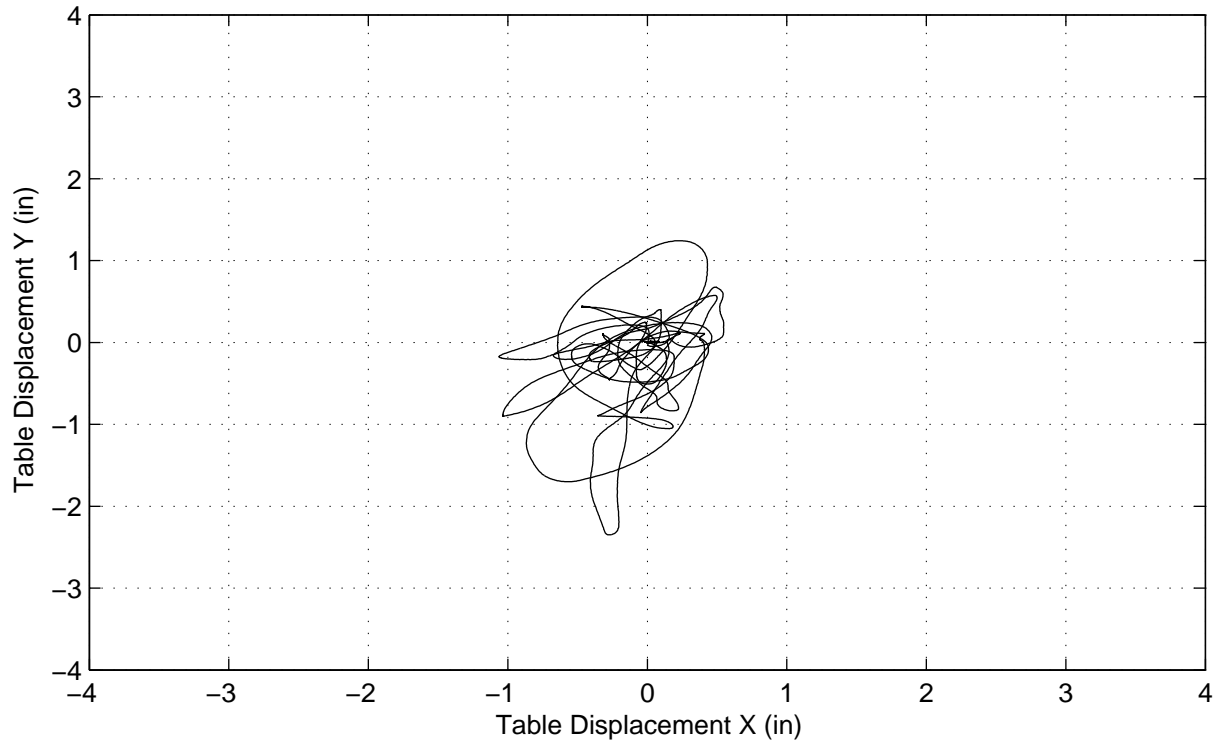

AP4 (Added Mass) – Test M, 2.5in. Long Period DBE – 0 deg Trans

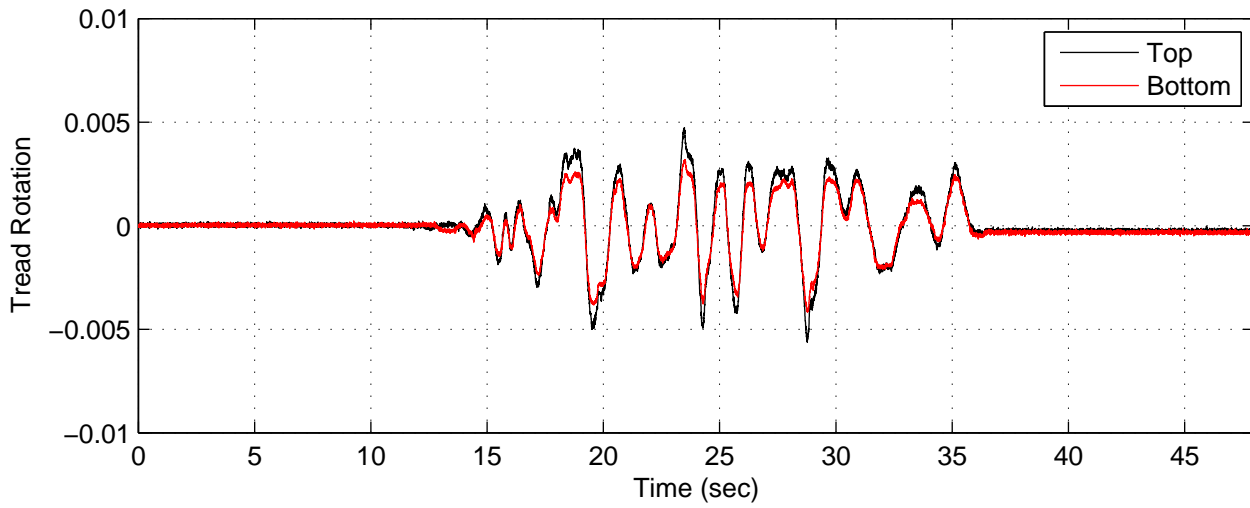
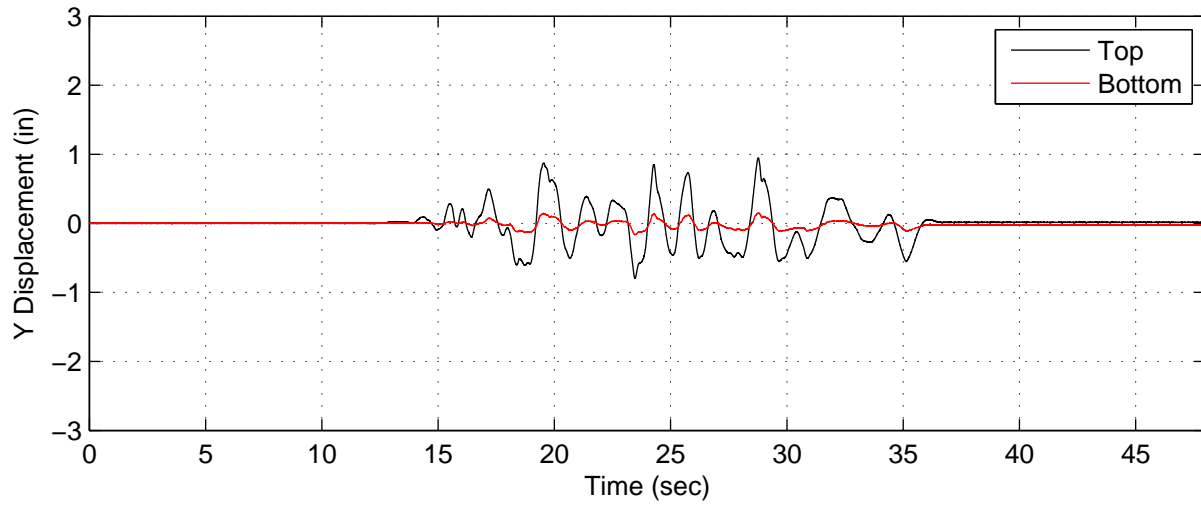
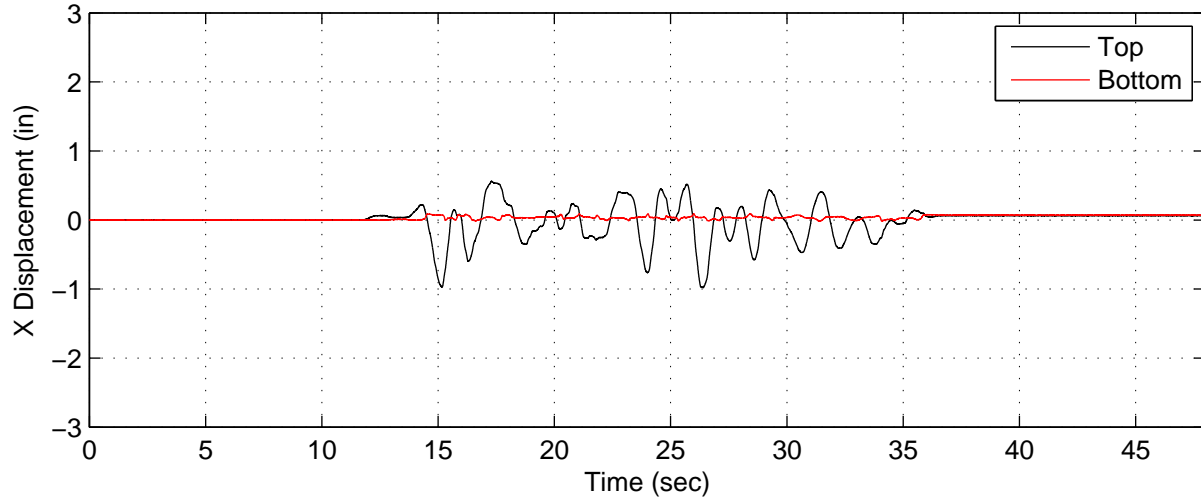



AP4 (Added Mass) – Test M, 2.5in. Long Period DBE – 0 deg Trans

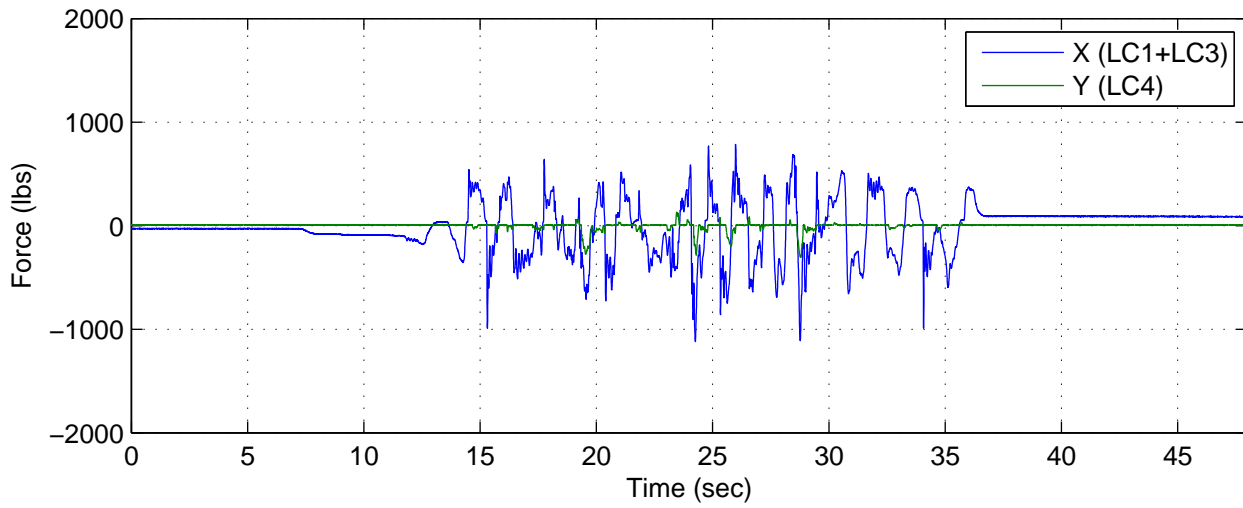
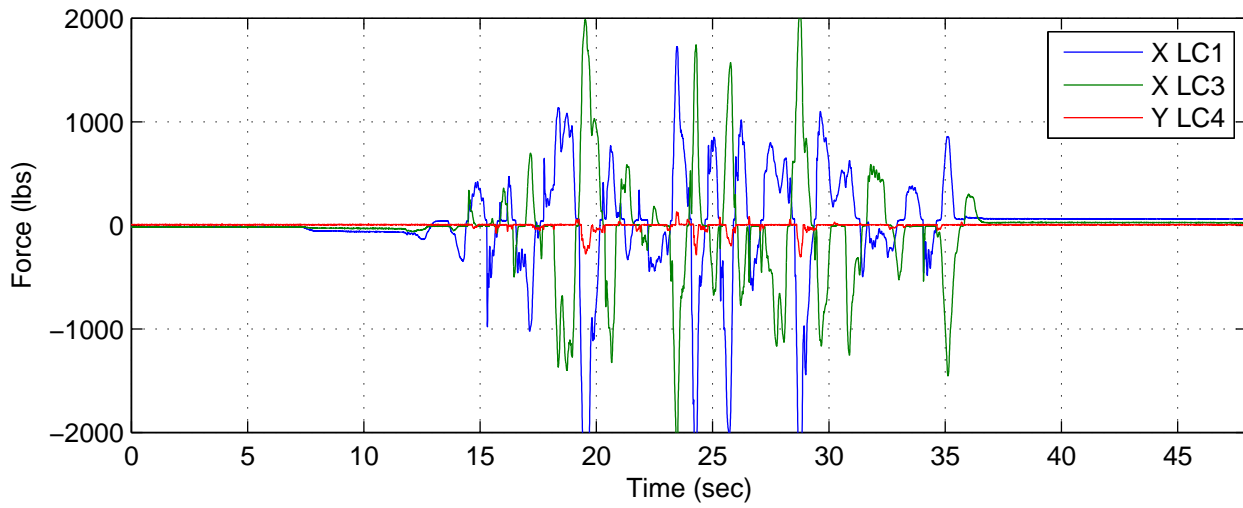
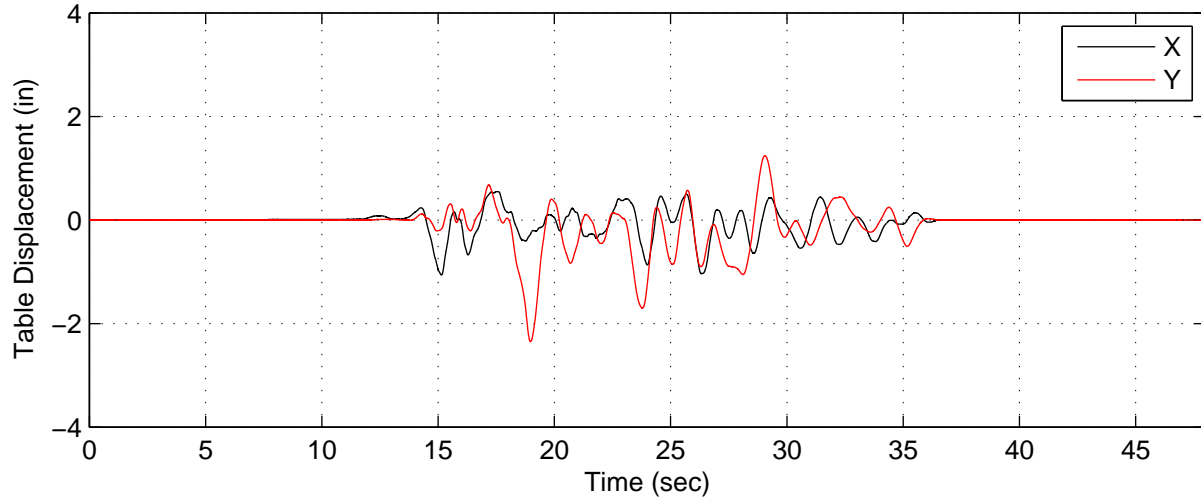

AP4 (Added Mass) – Test M, 2.5in. Long Period DBE – 0 deg Trans

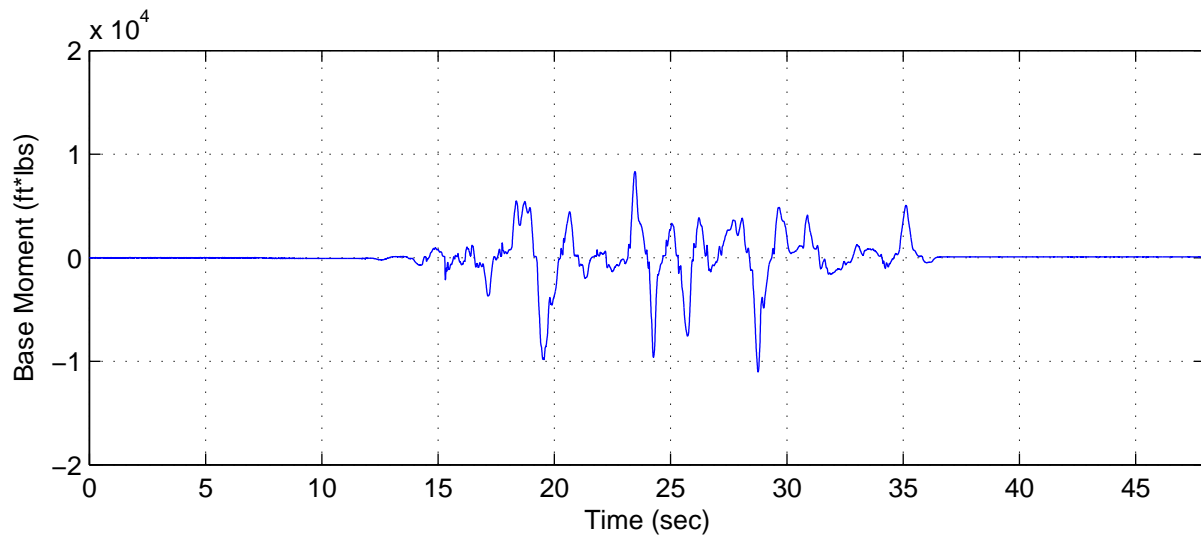
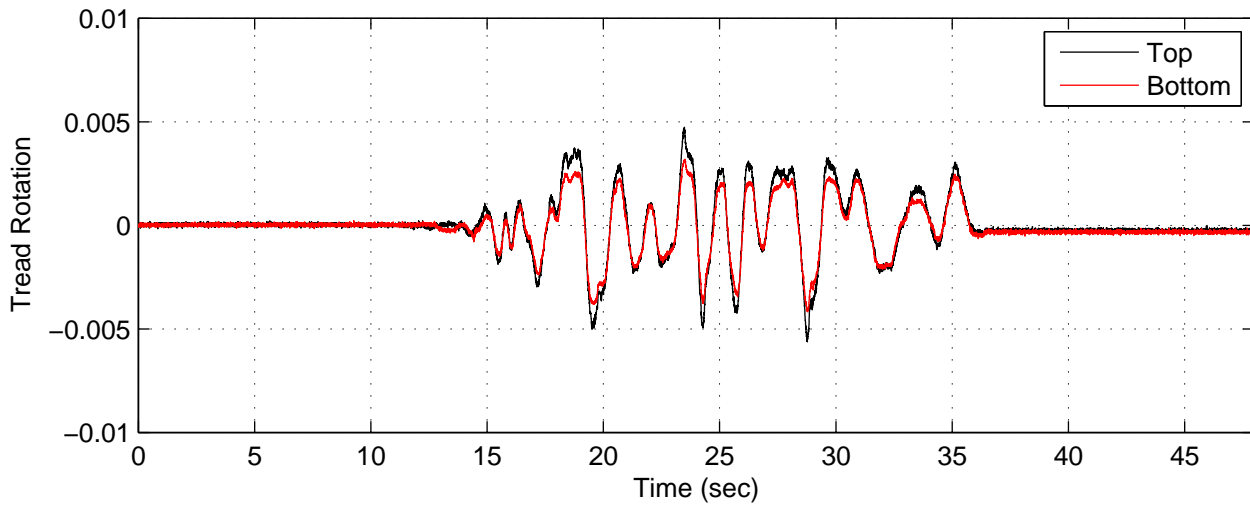
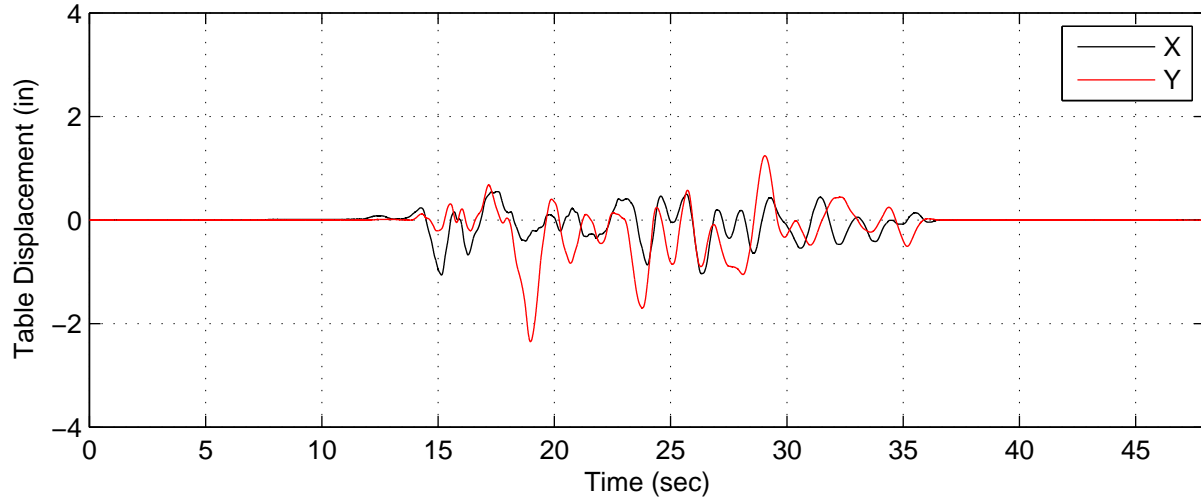

AP4 (Added Mass) – Test N, 2.5in. Newhall DBE – 0 deg Long

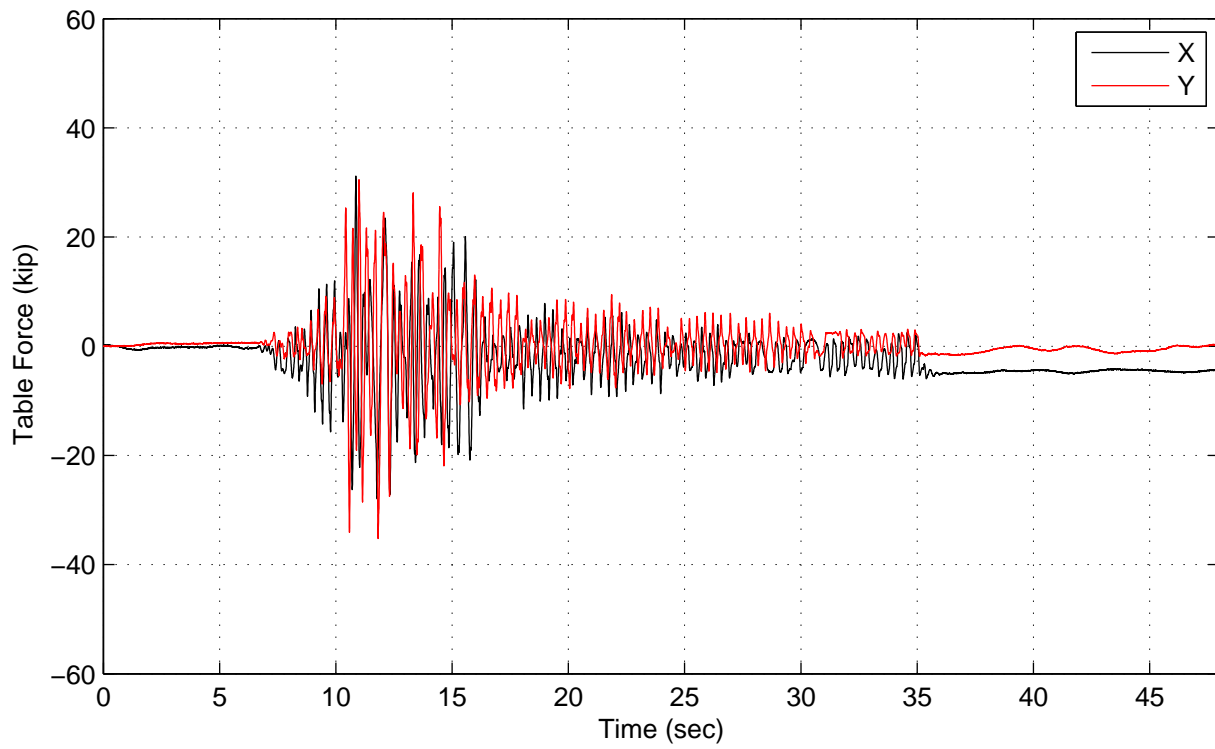
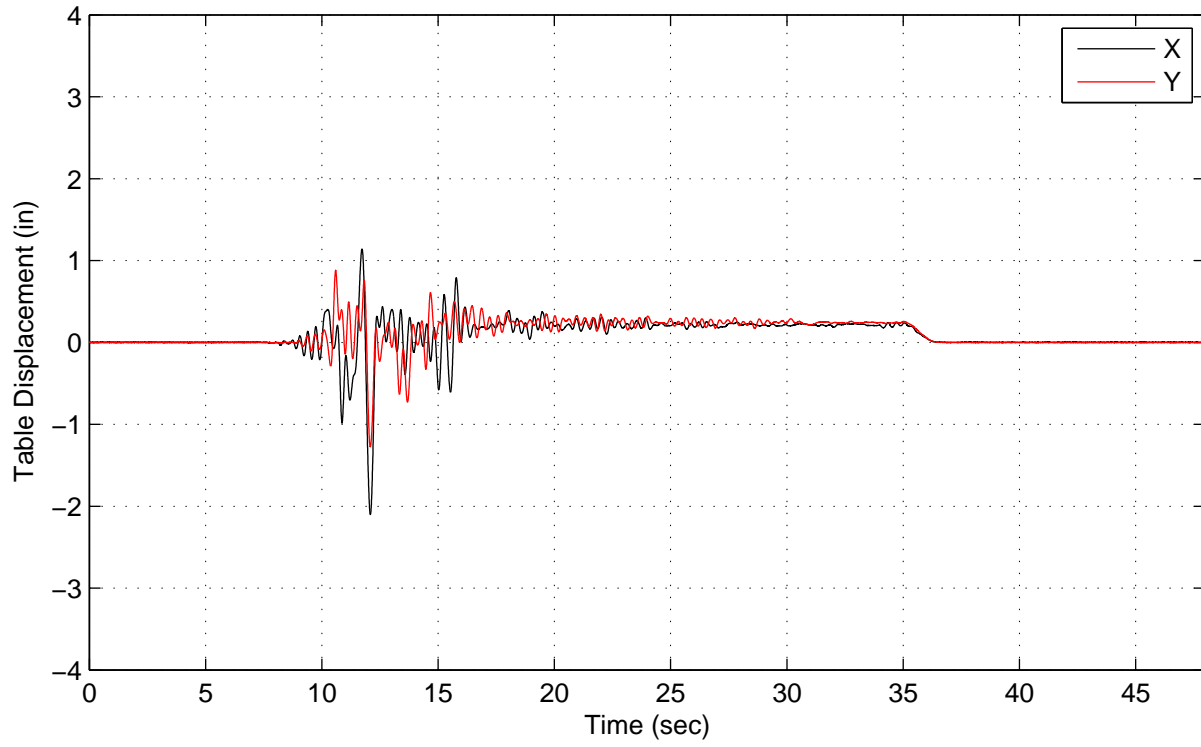

AP4 (Added Mass) – Test N, 2.5in. Newhall DBE – 0 deg Long

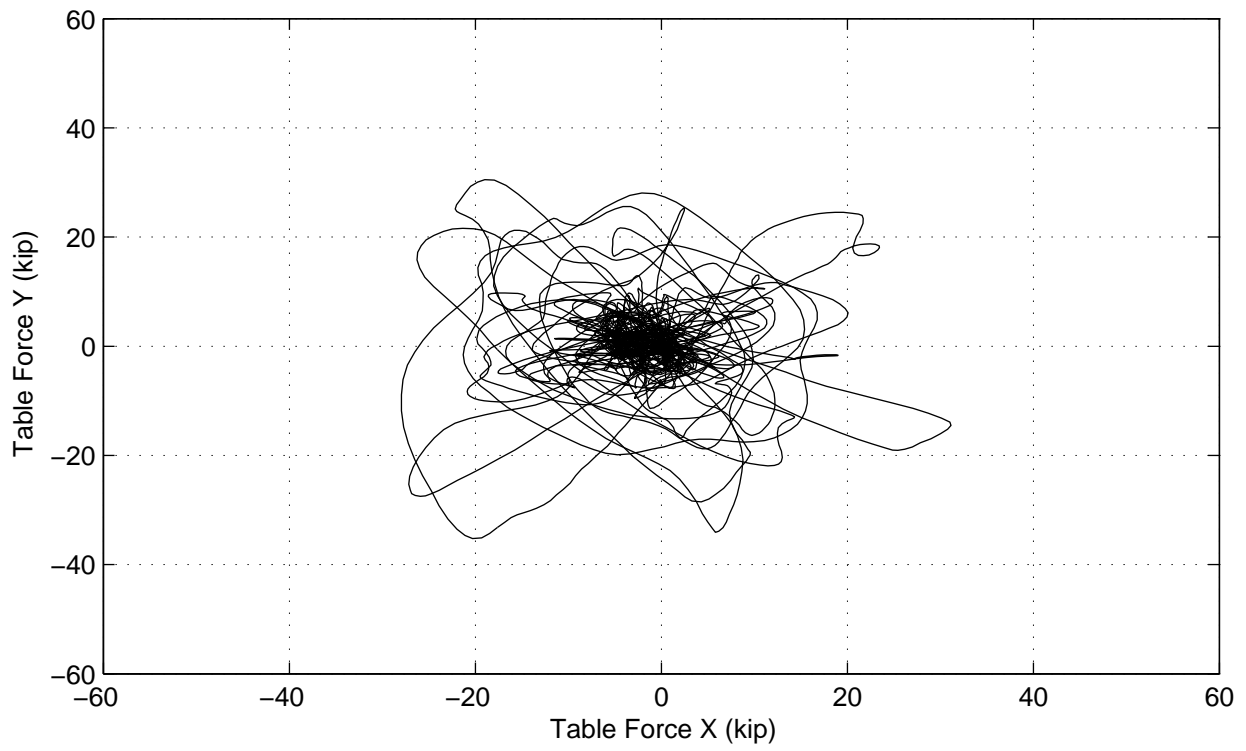
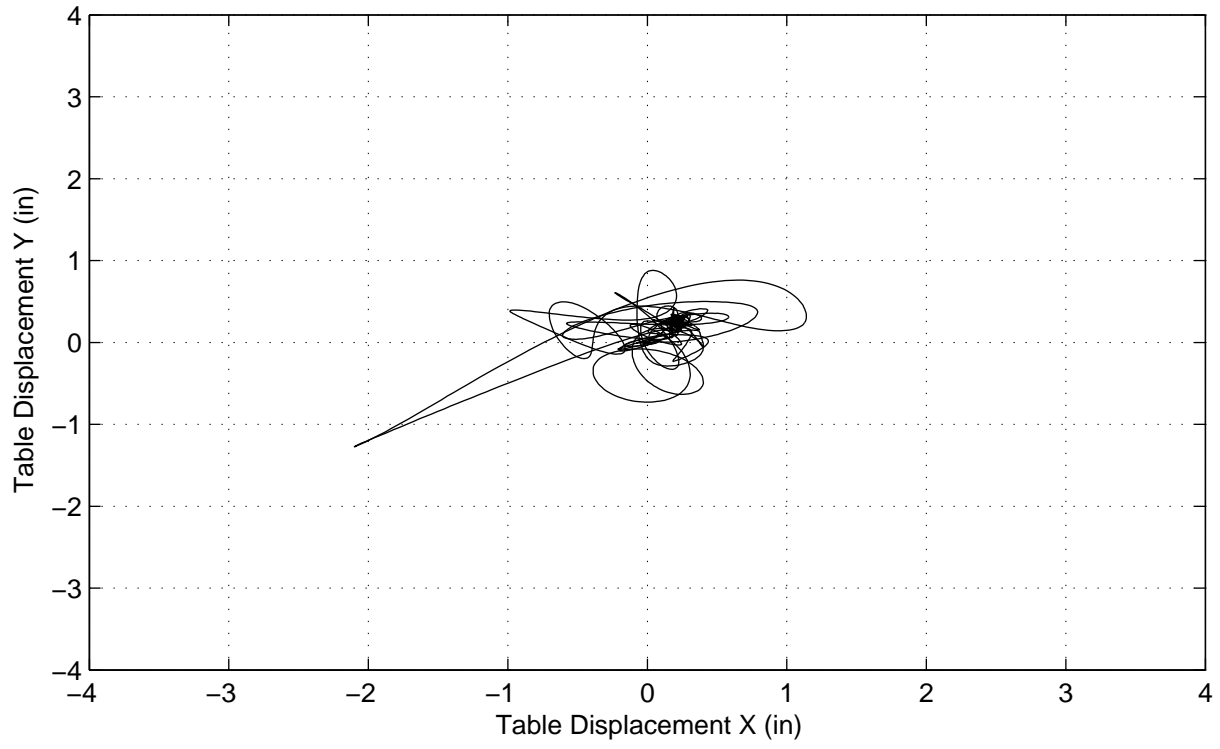

AP4 (Added Mass) – Test N, 2.5in. Newhall DBE – 0 deg Long

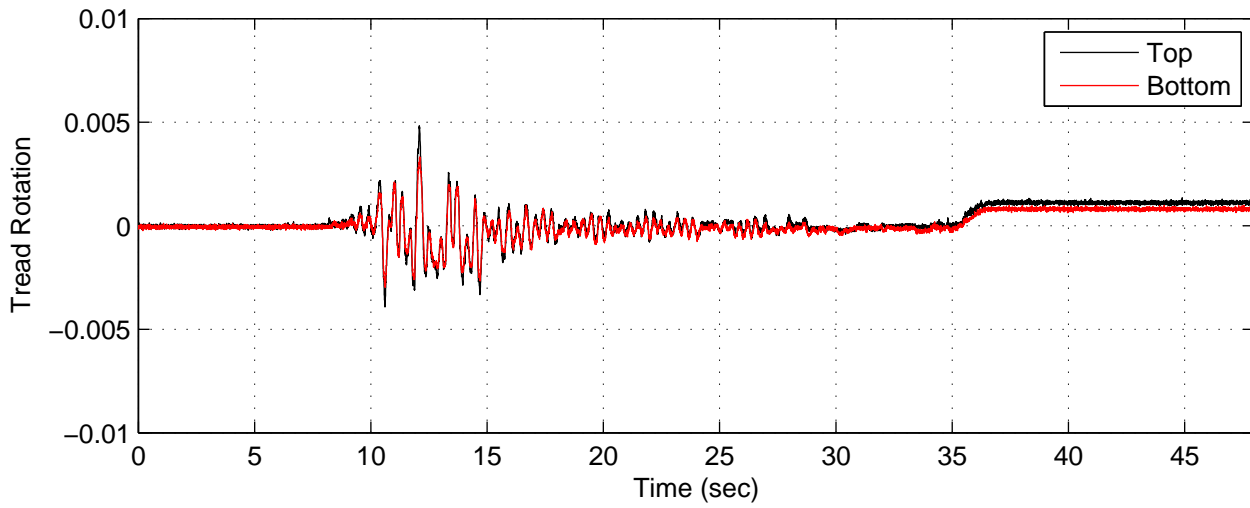
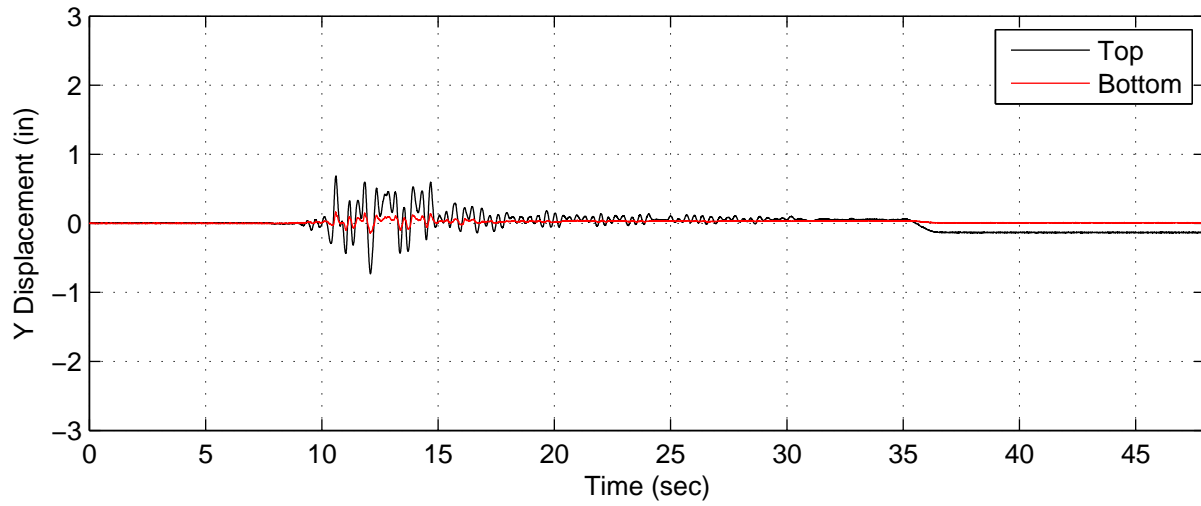
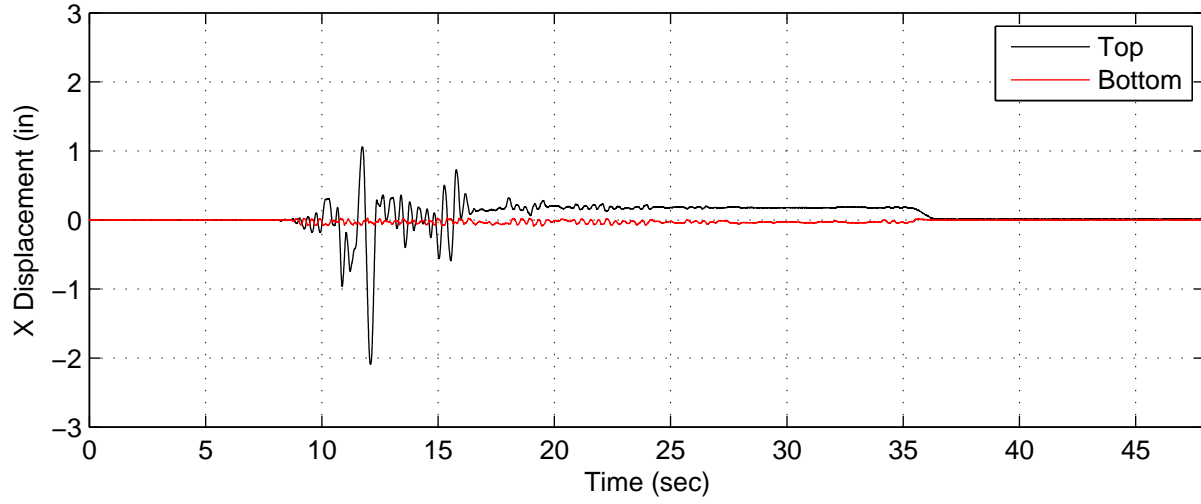

AP4 (Added Mass) – Test N, 2.5in. Newhall DBE – 0 deg Long

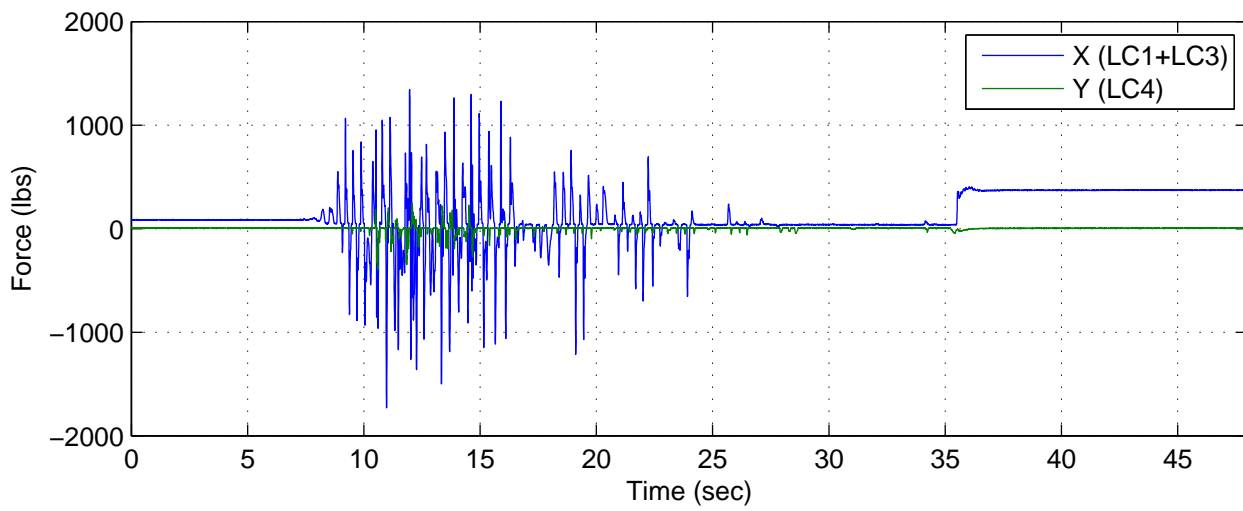
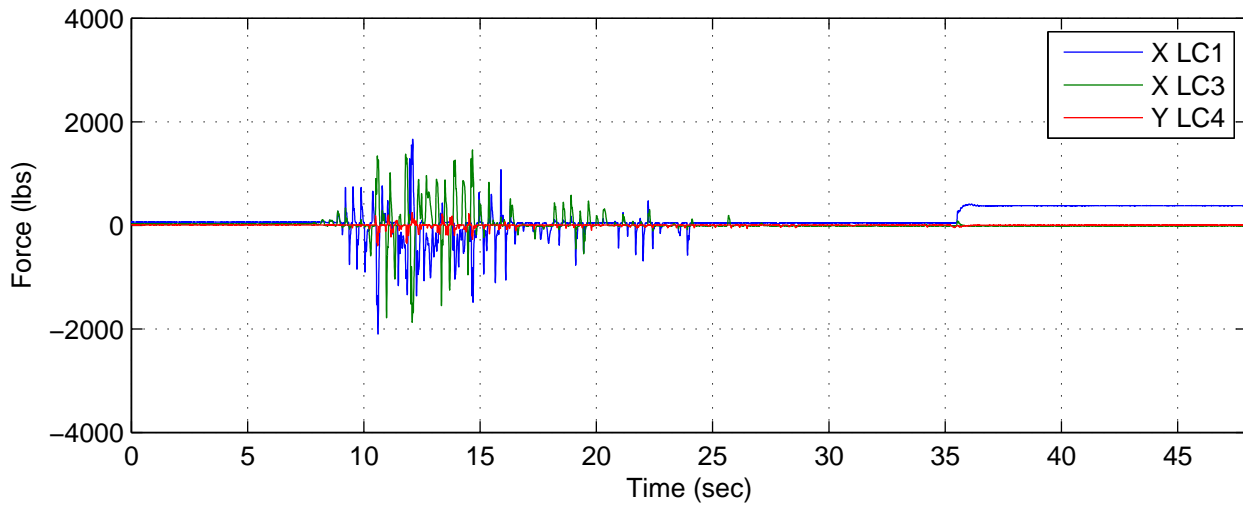
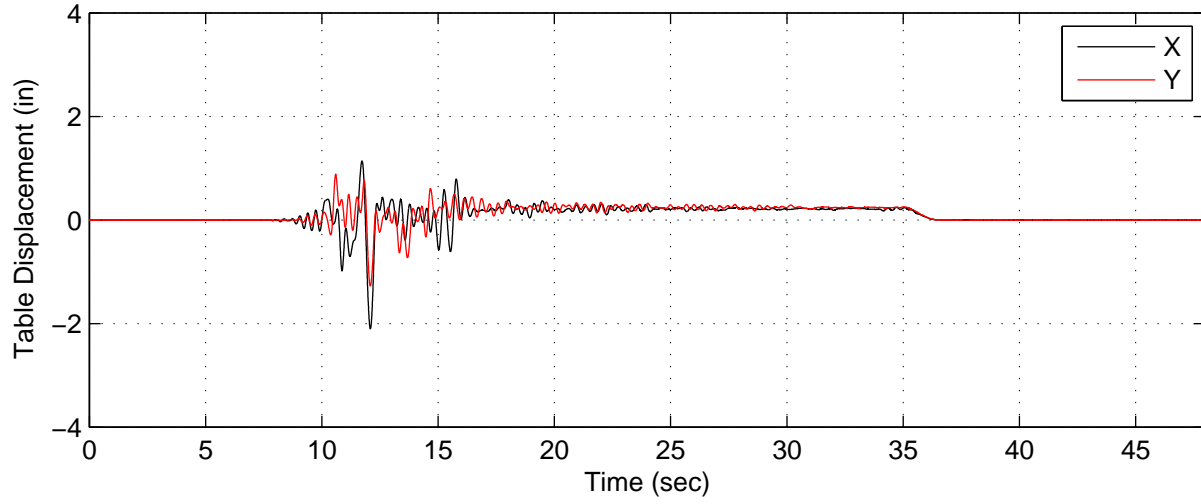

AP4 (Added Mass) – Test N, 2.5in. Newhall DBE – 0 deg Long

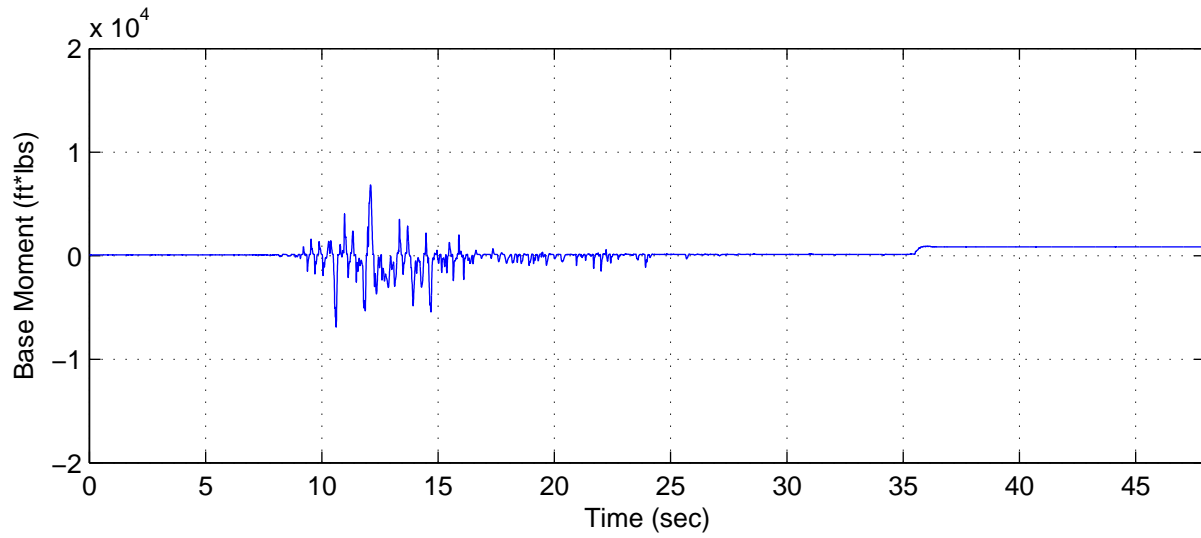
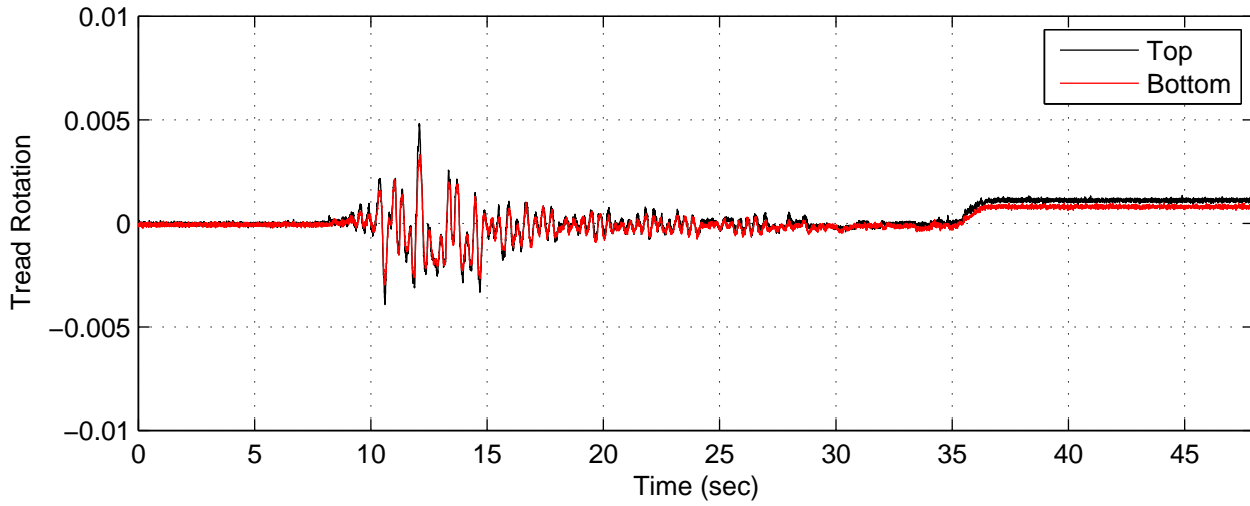
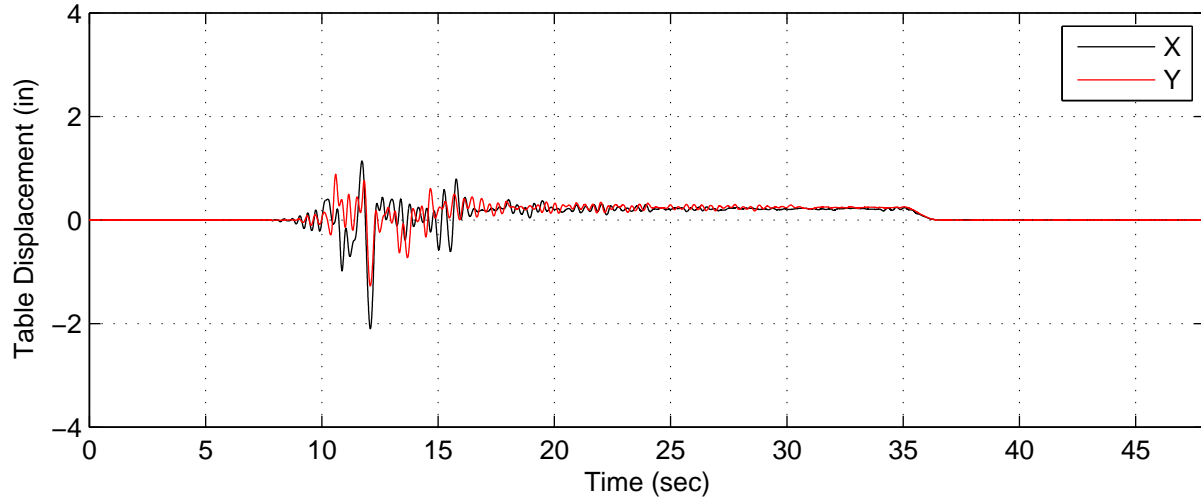

AP4 (Added Mass) – Test O, 2.5in. Newhall DBE – 0 deg Trans

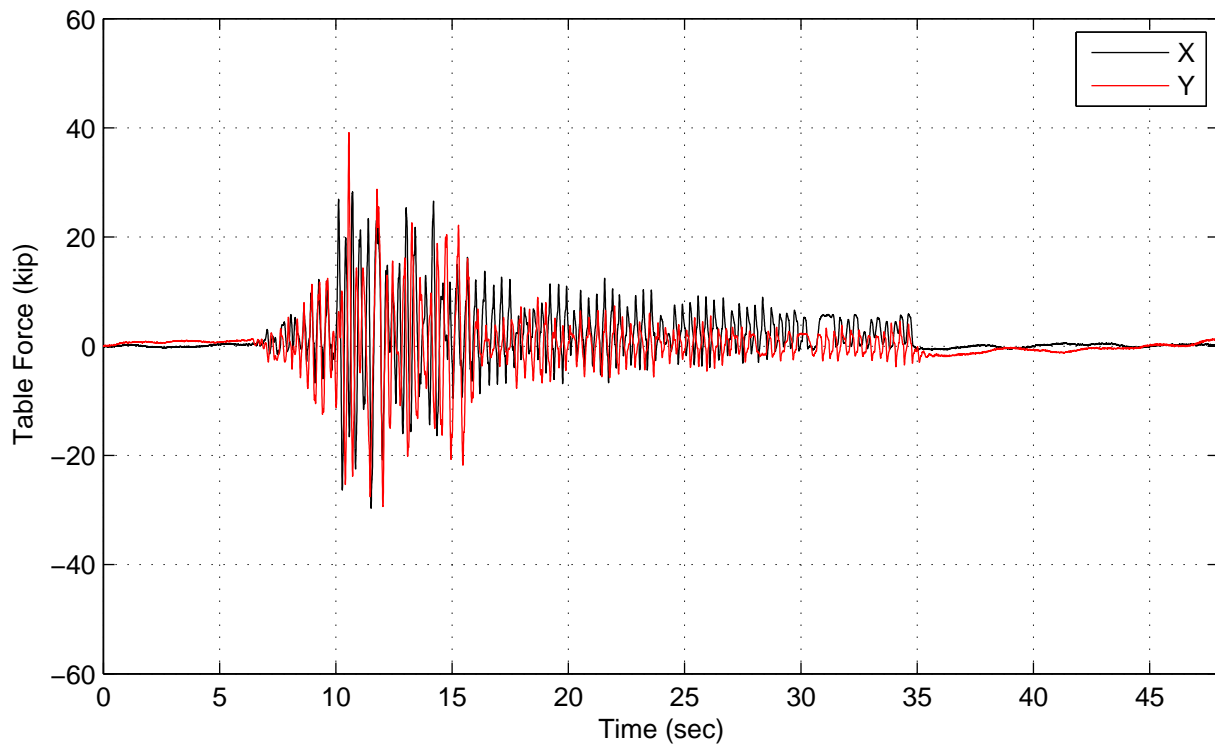
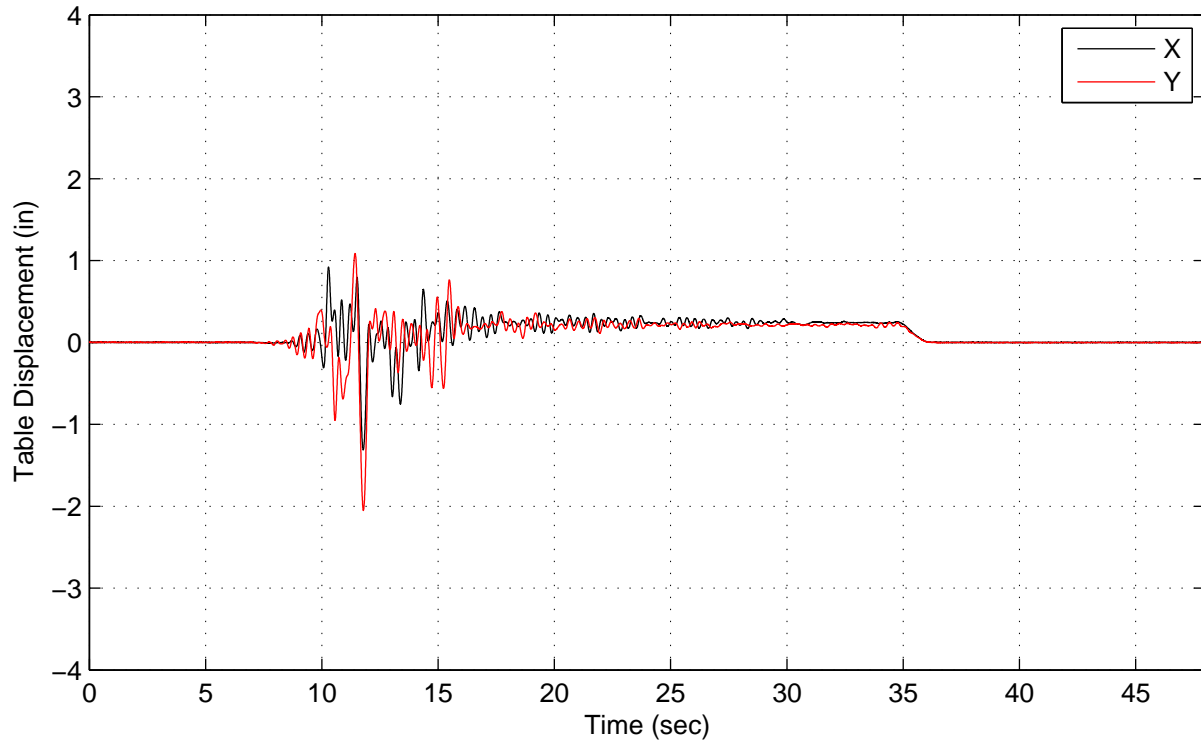



AP4 (Added Mass) – Test O, 2.5in. Newhall DBE – 0 deg Trans

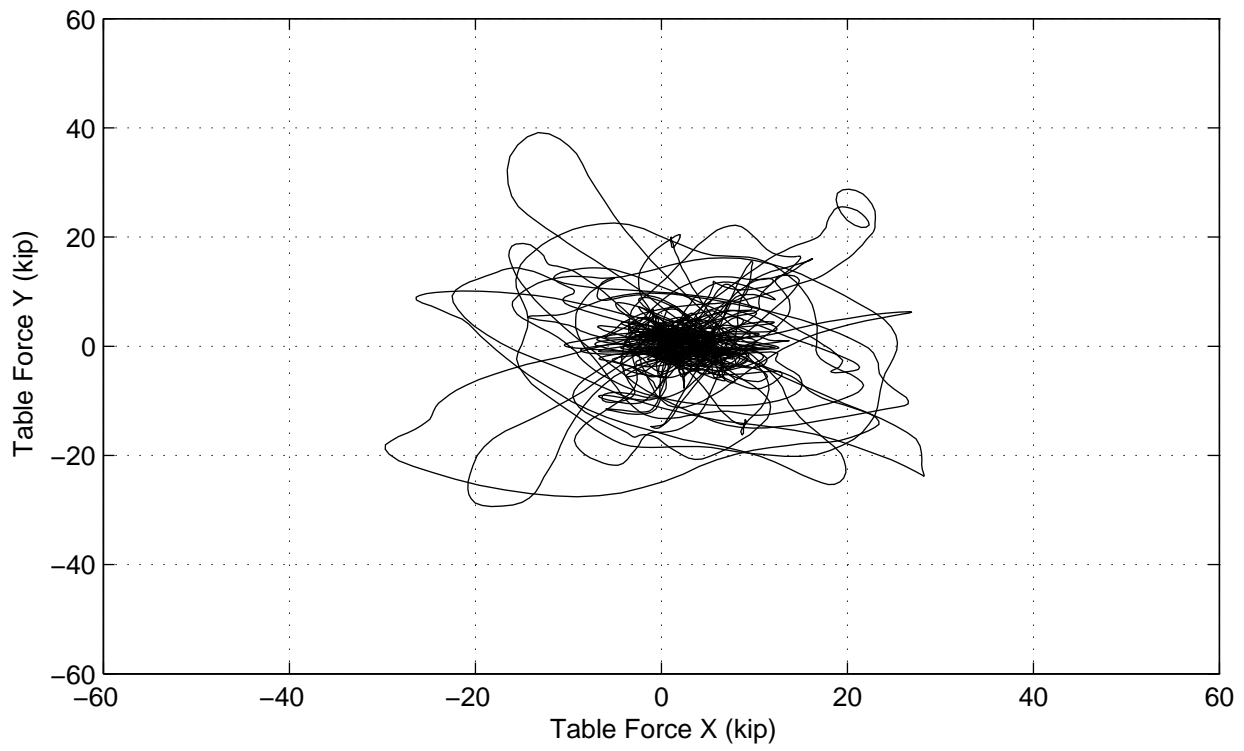
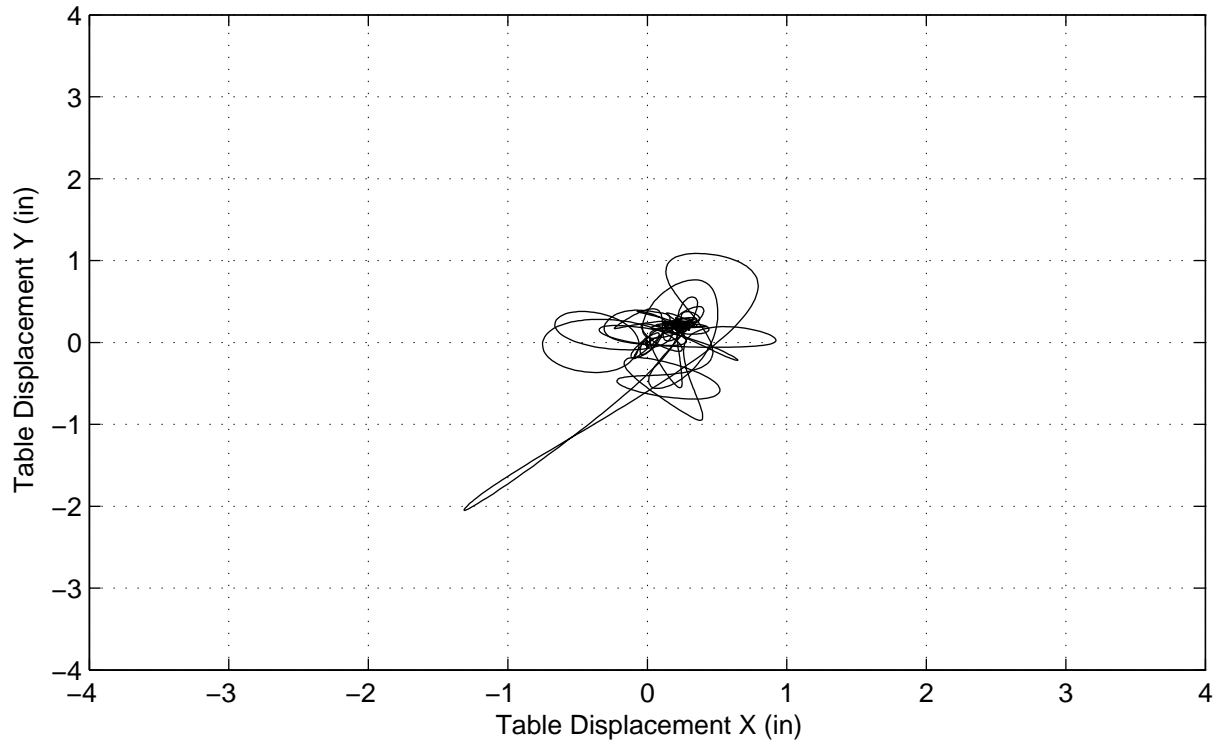

AP4 (Added Mass) – Test O, 2.5in. Newhall DBE – 0 deg Trans

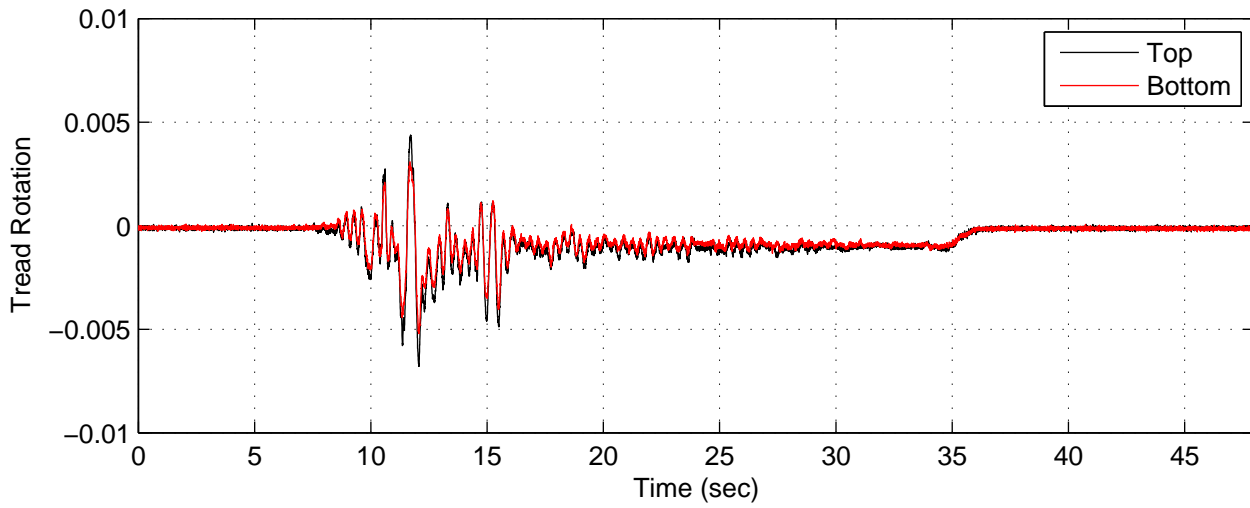
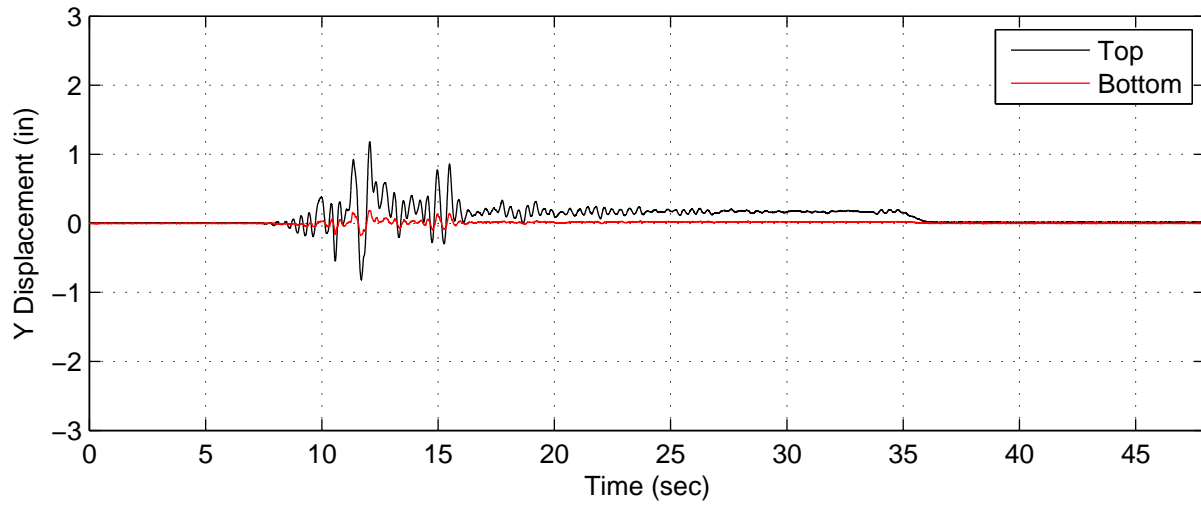
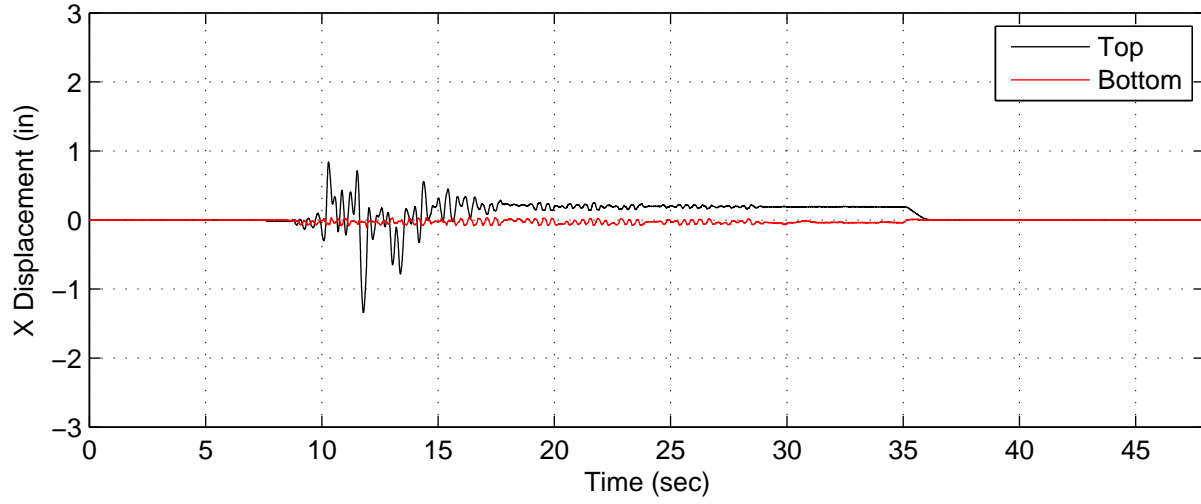

AP4 (Added Mass) – Test O, 2.5in. Newhall DBE – 0 deg Trans

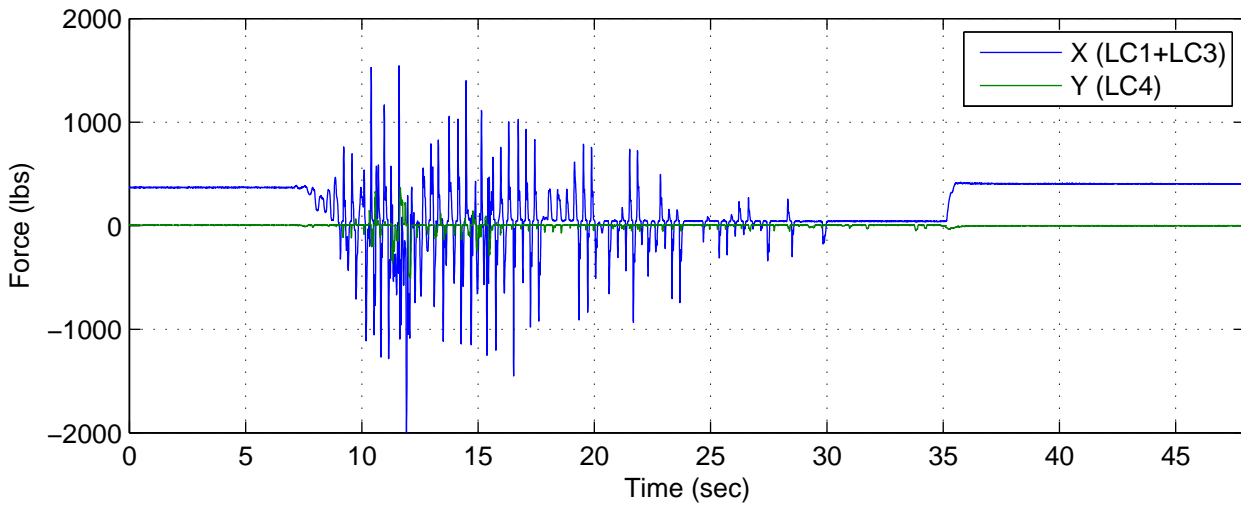
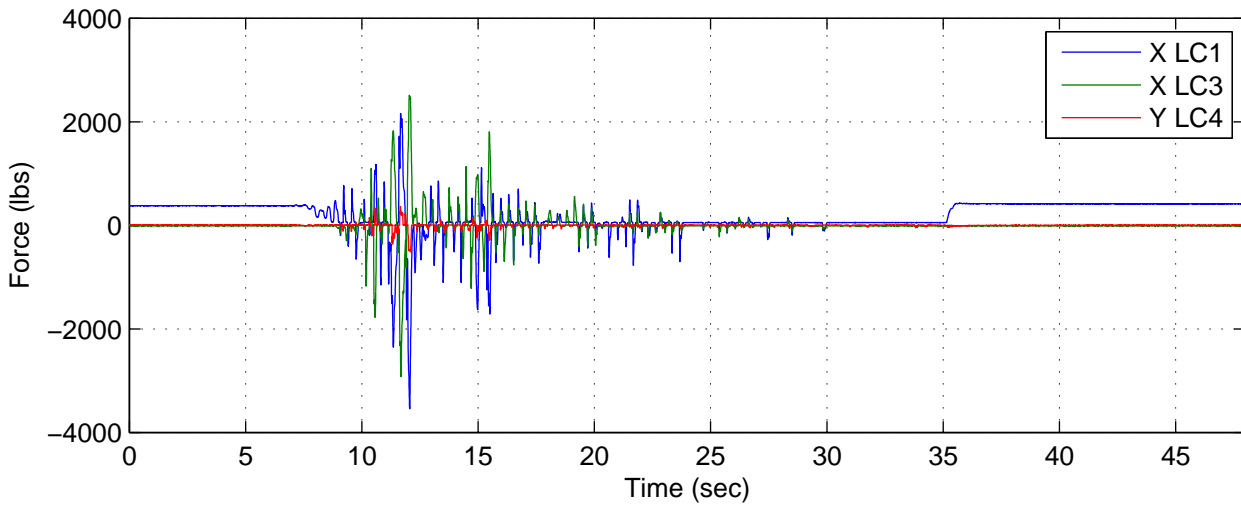
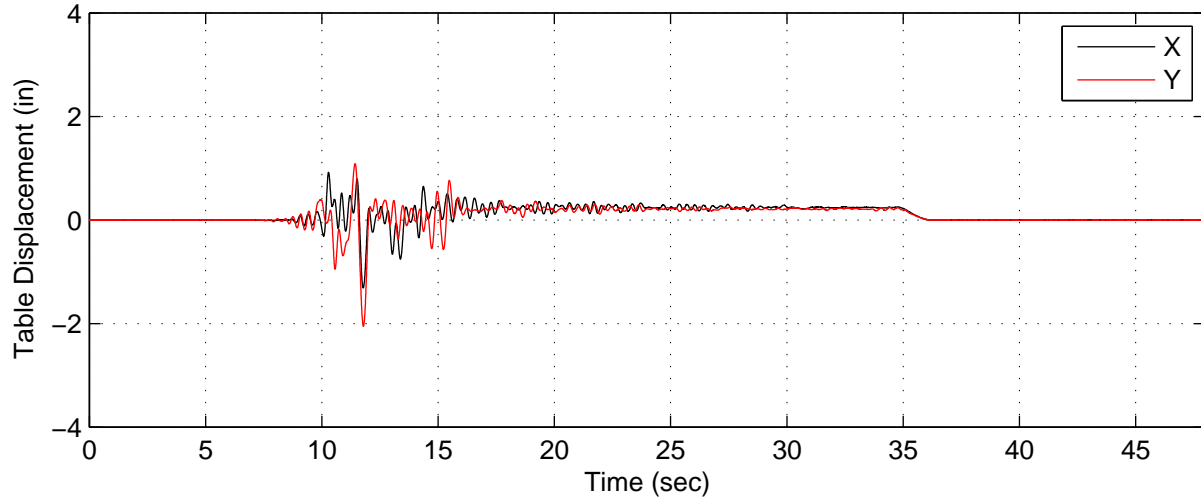

AP4 (Added Mass) – Test O, 2.5in. Newhall DBE – 0 deg Trans

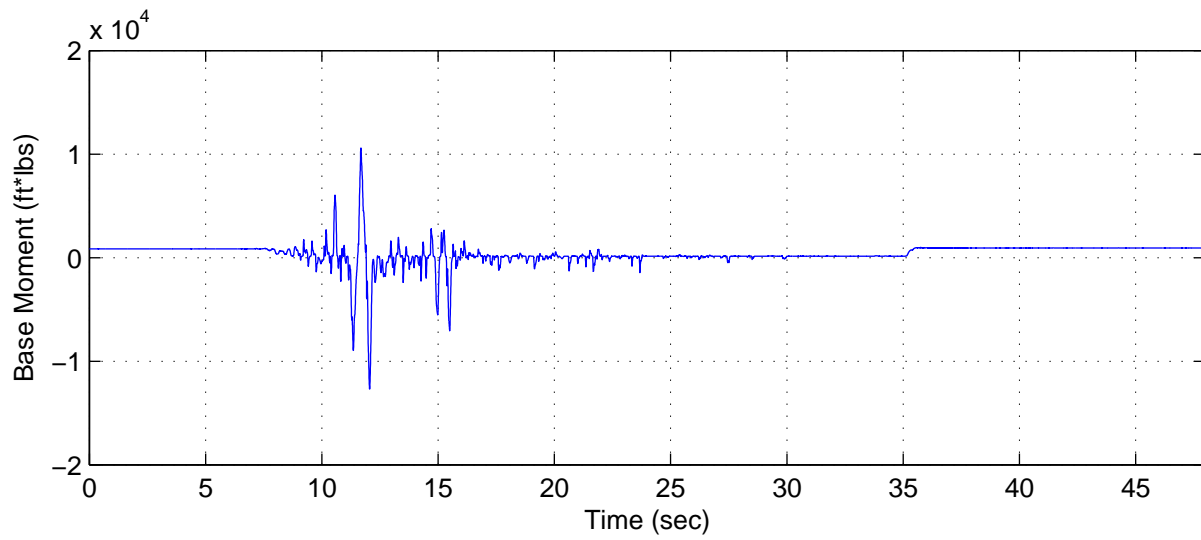
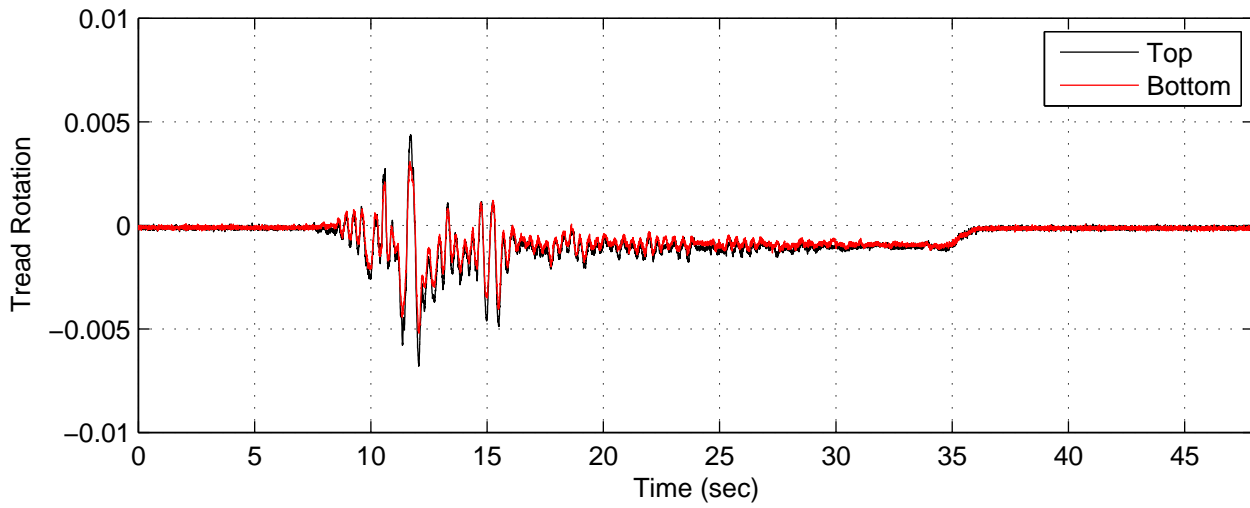
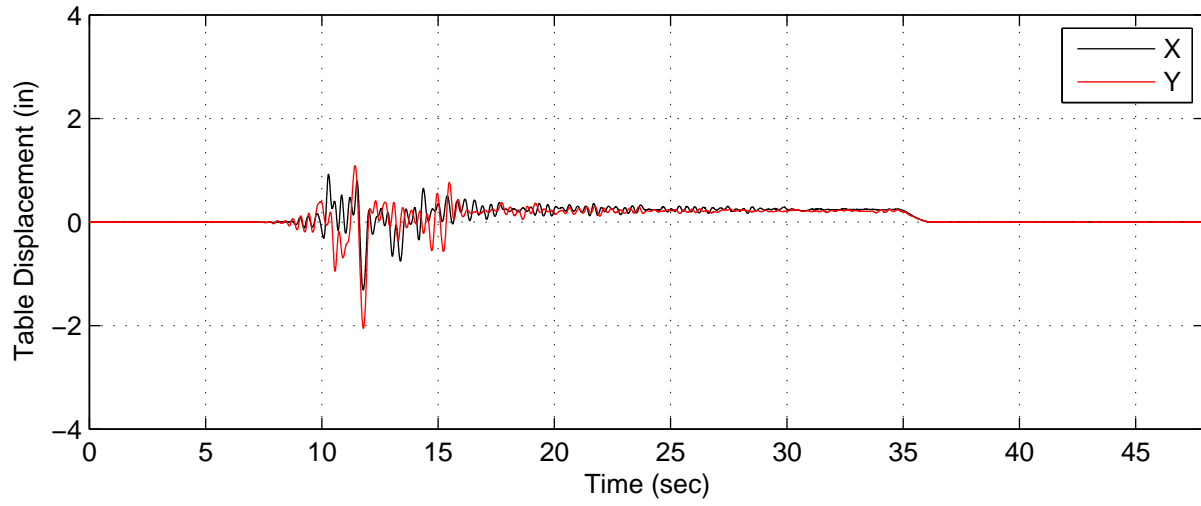

AP4 (Added Mass) – Test P, 3.75in. Newhall MCE – 0 deg Long

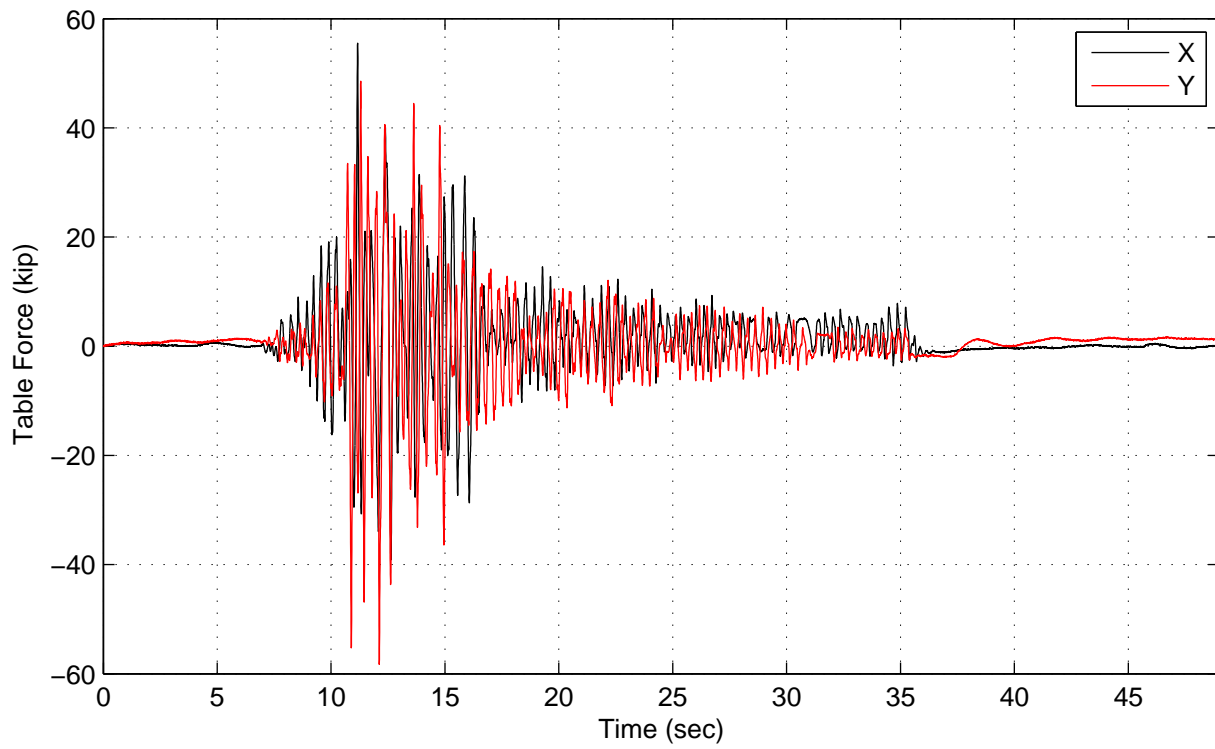
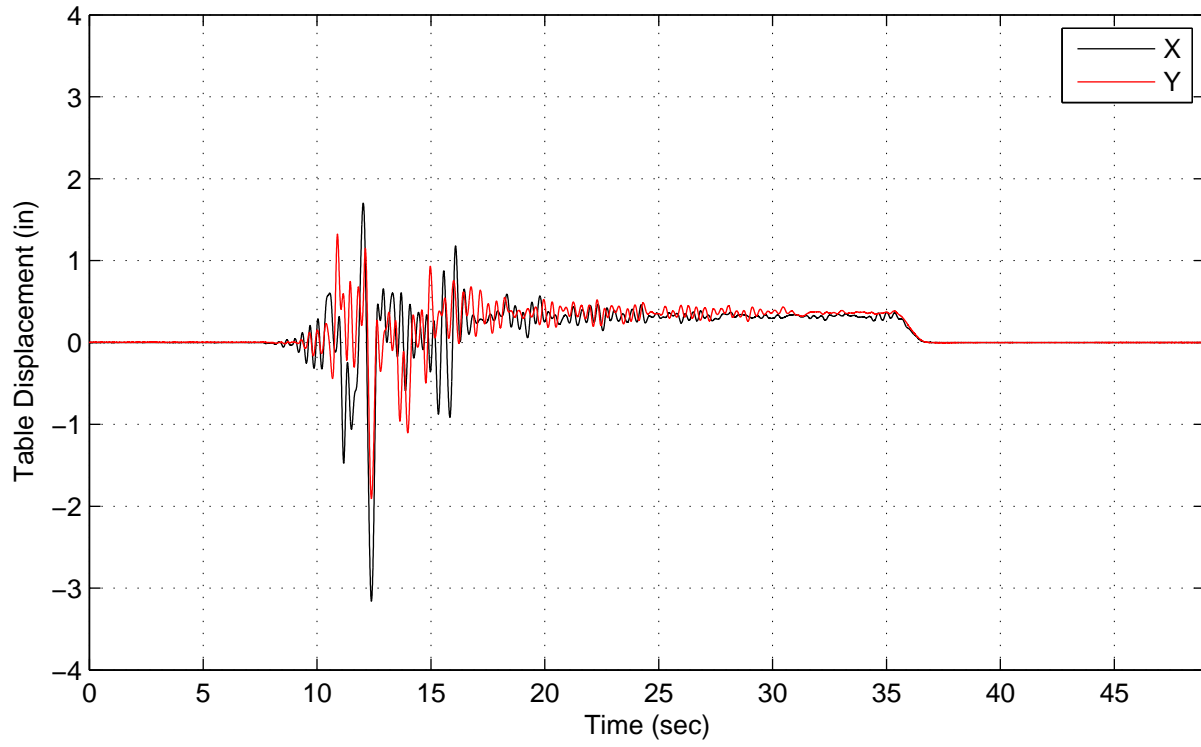

AP4 (Added Mass) – Test P, 3.75in. Newhall MCE – 0 deg Long

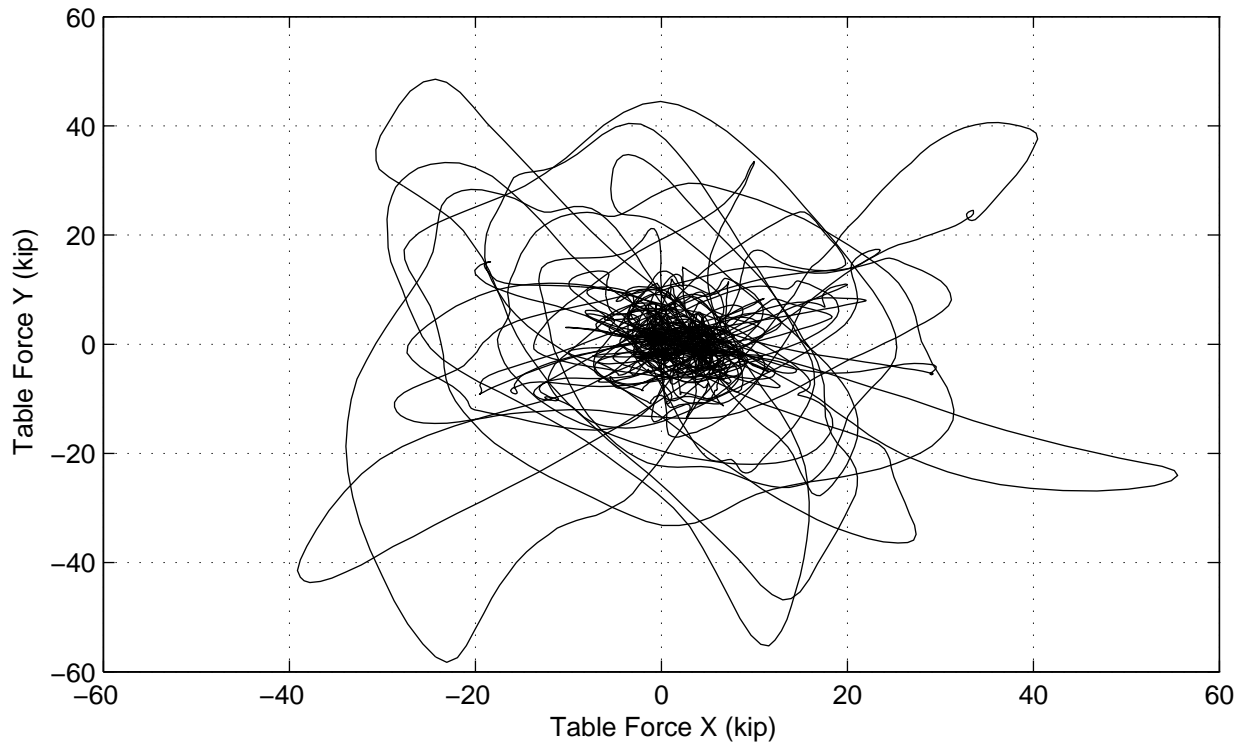
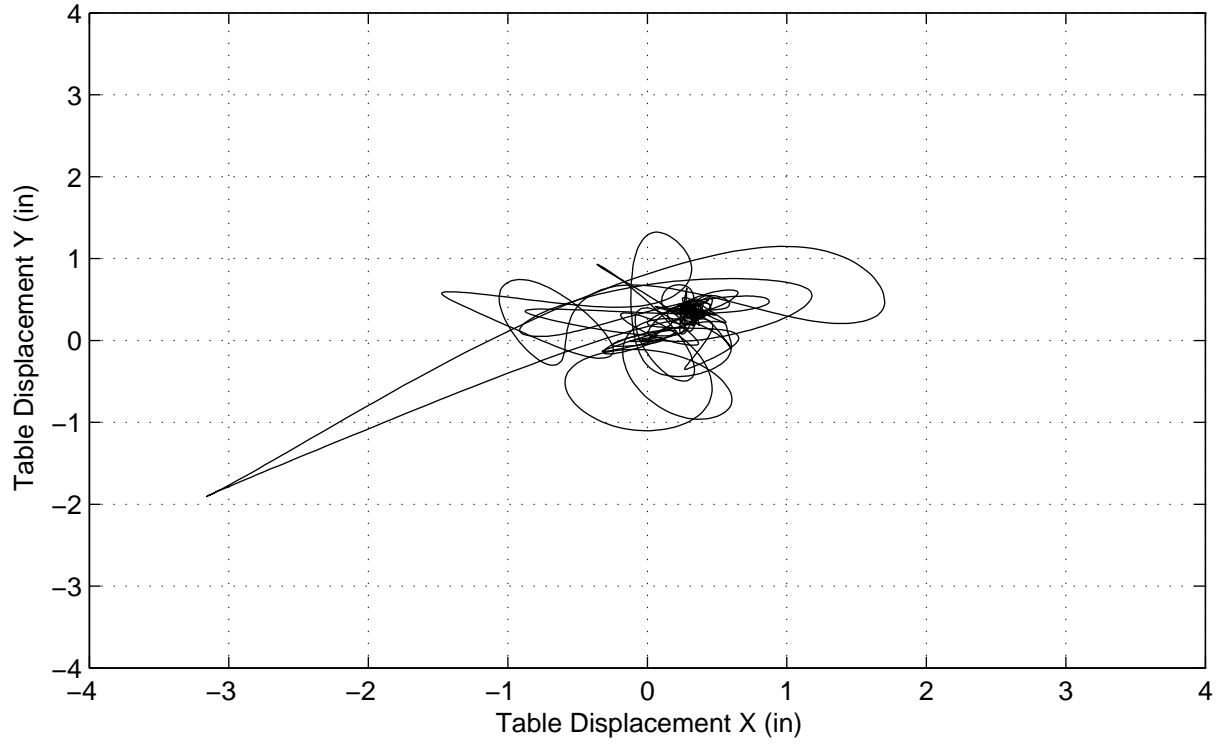

AP4 (Added Mass) – Test P, 3.75in. Newhall MCE – 0 deg Long

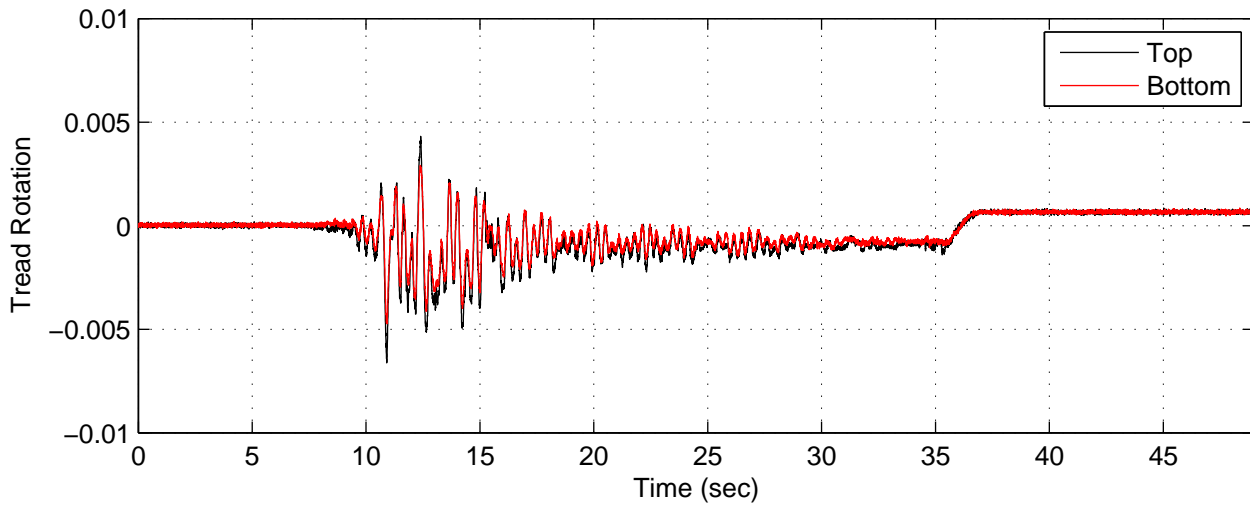
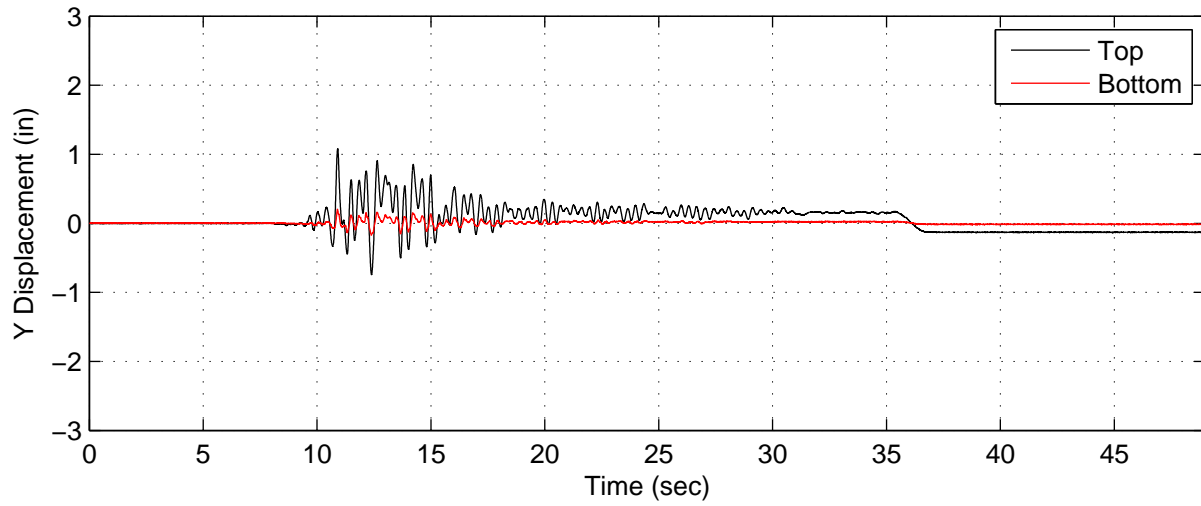
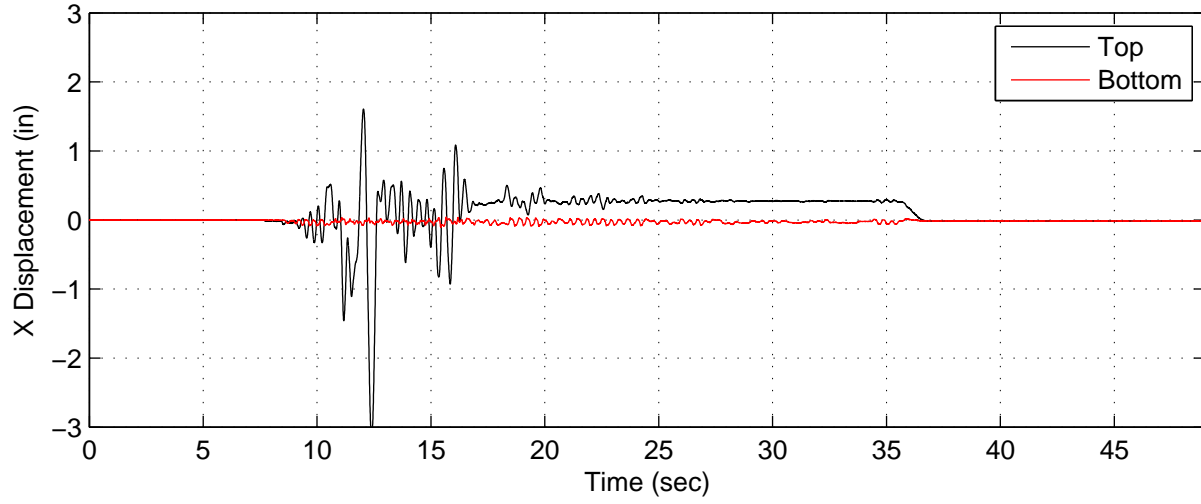

AP4 (Added Mass) – Test P, 3.75in. Newhall MCE – 0 deg Long

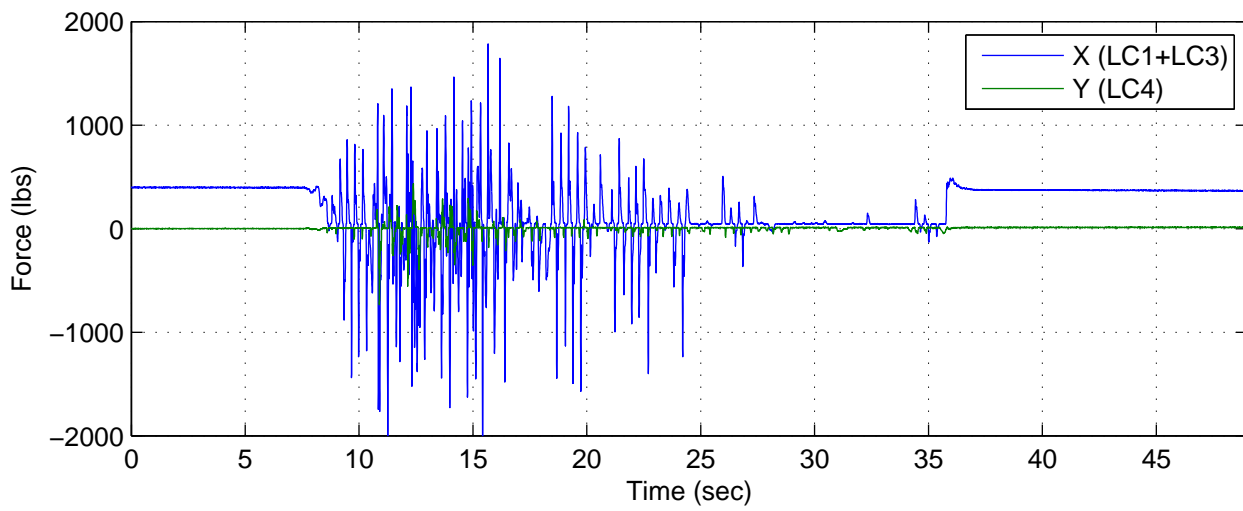
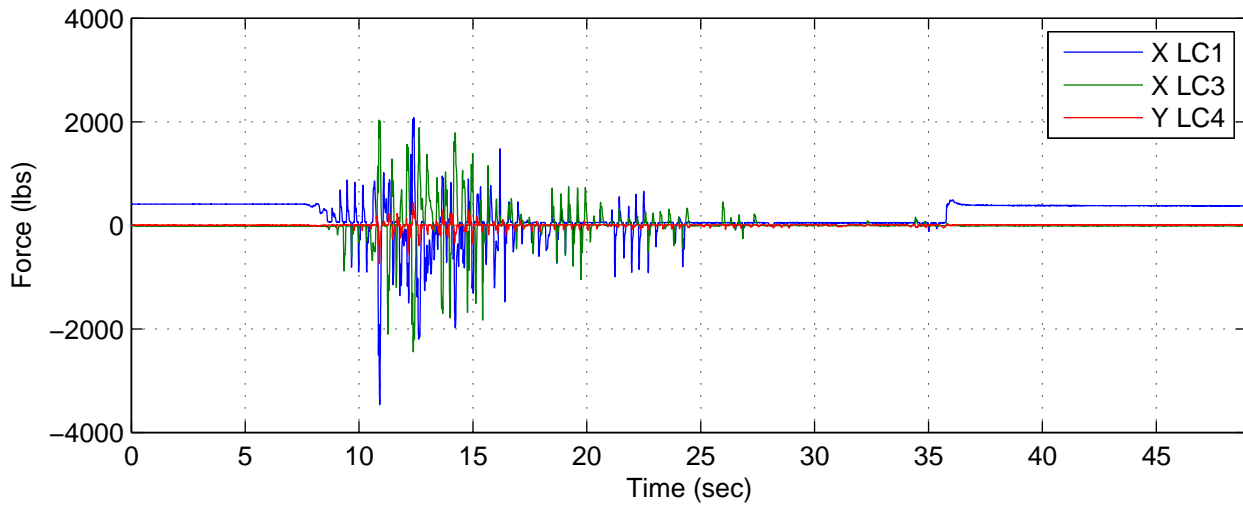
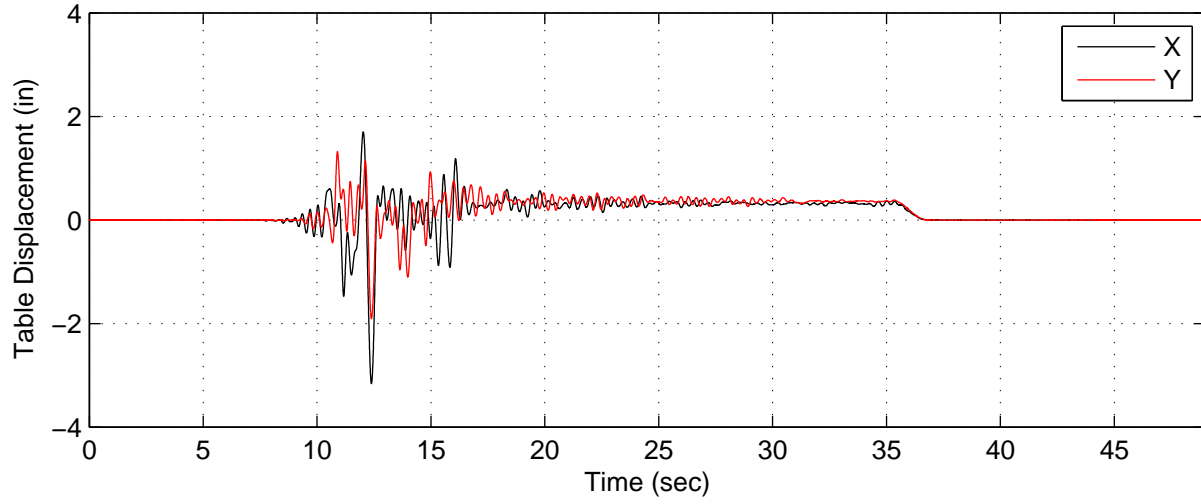



AP4 (Added Mass) – Test P, 3.75in. Newhall MCE – 0 deg Long

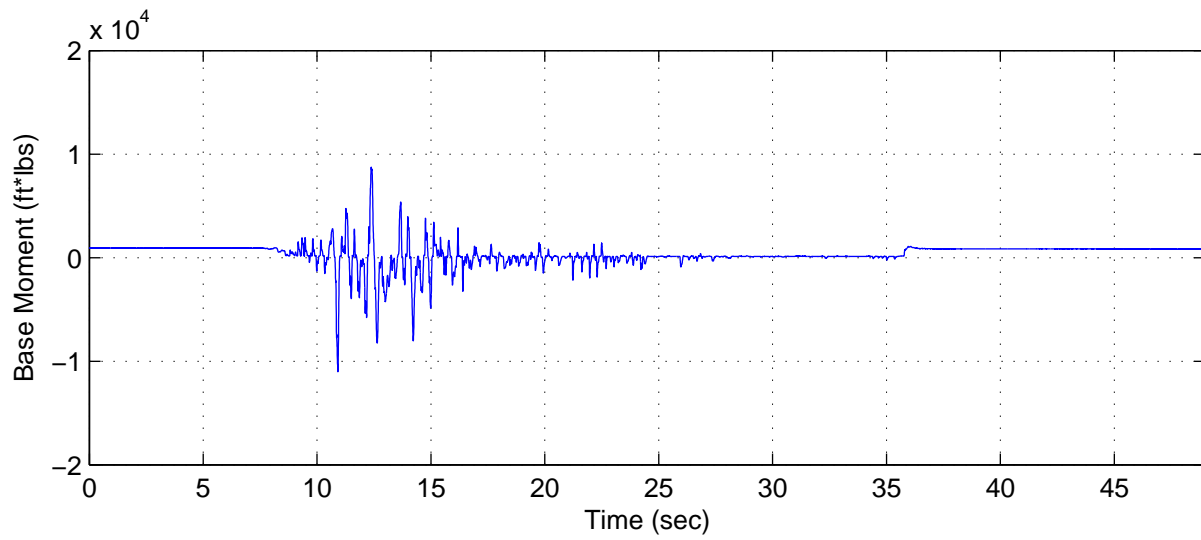
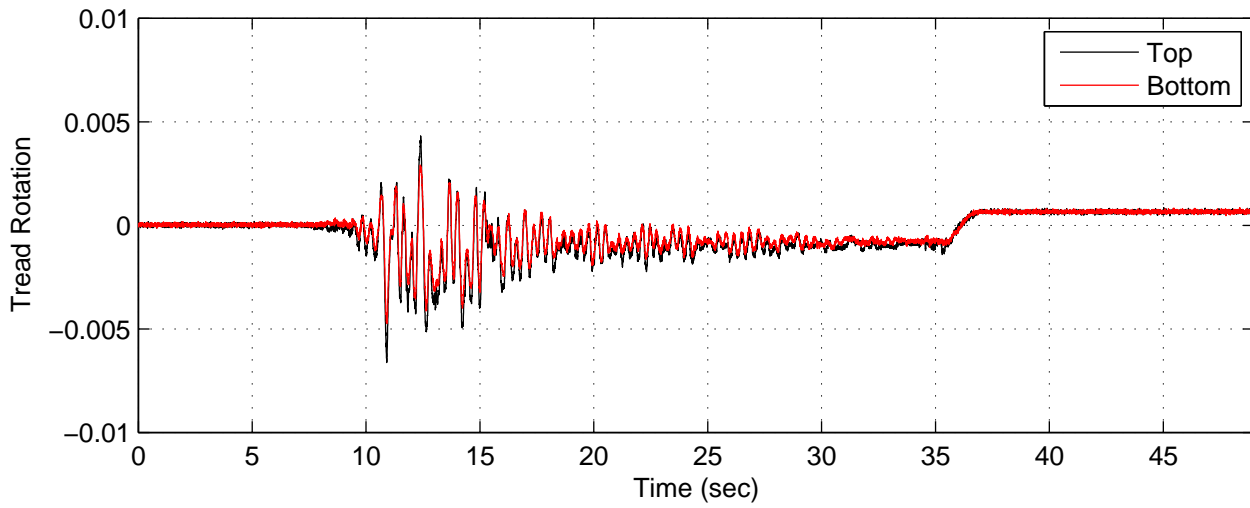
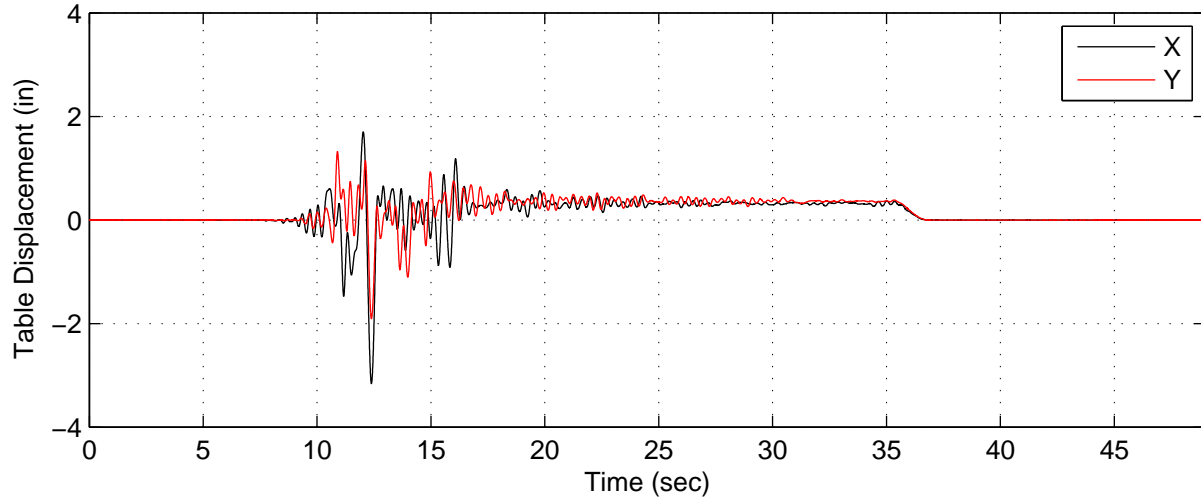

AP4 (Added Mass) – Test Q, 3.75in. Newhall MCE – 0 deg Trans

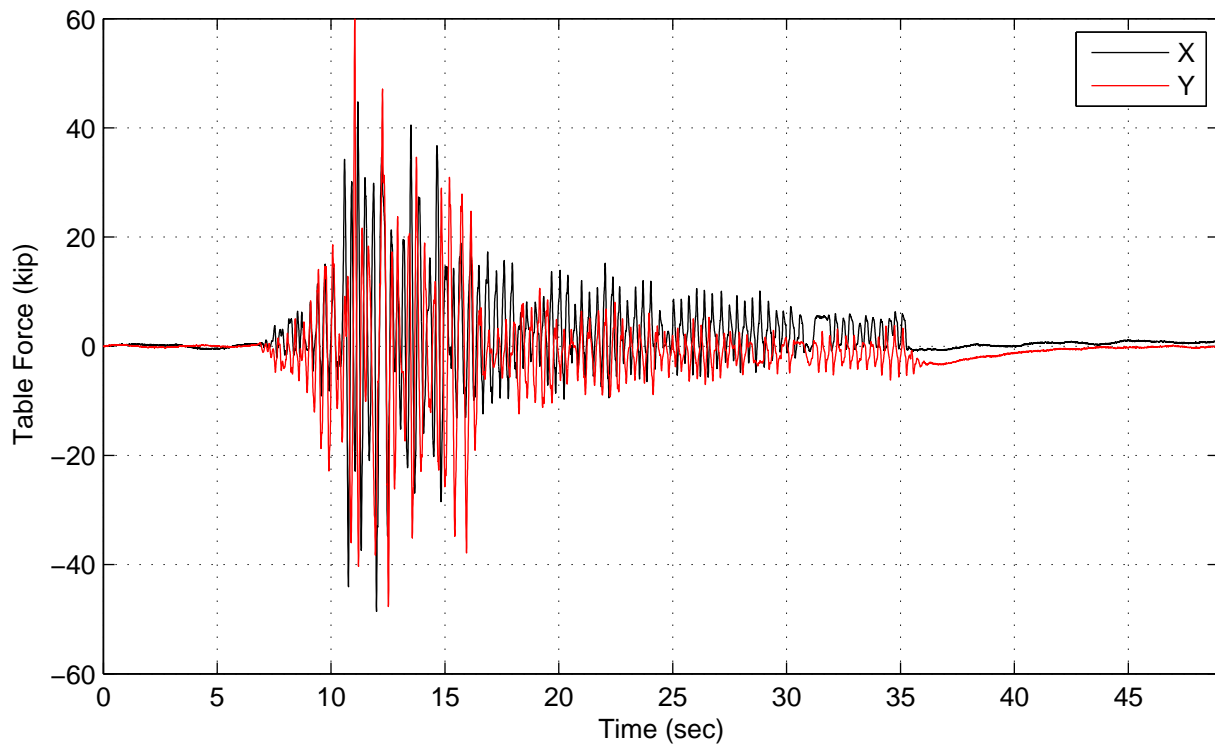
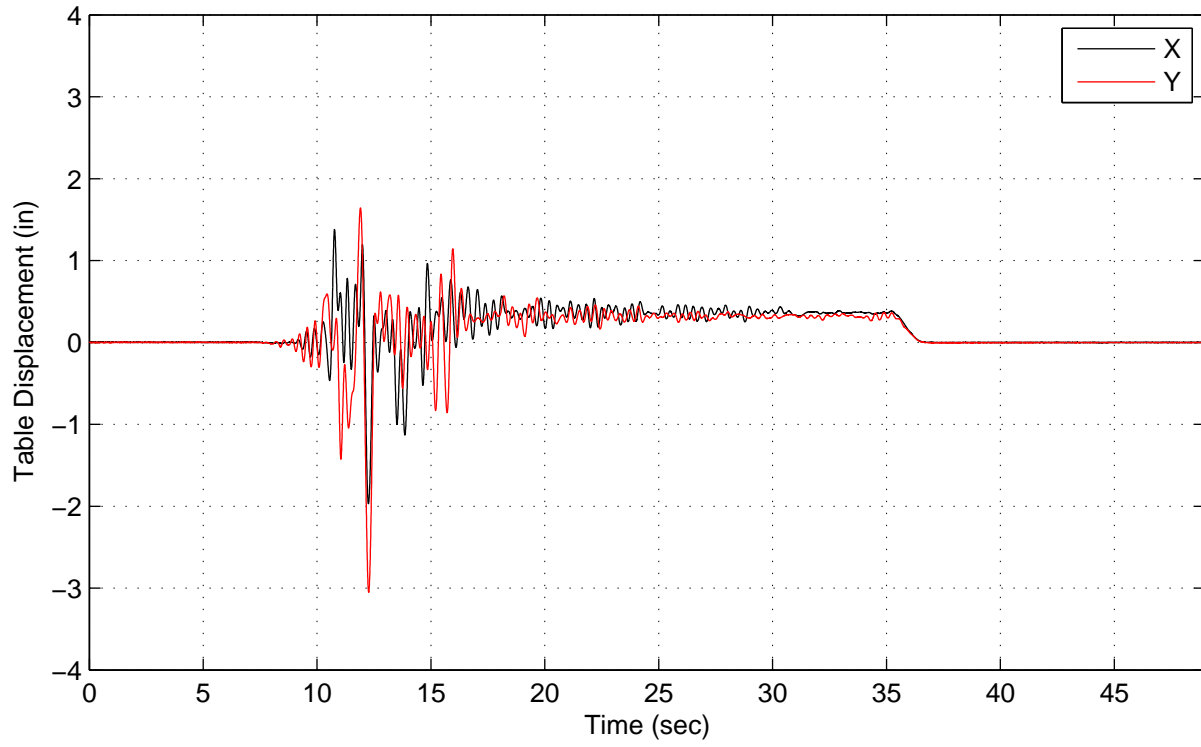

AP4 (Added Mass) – Test Q, 3.75in. Newhall MCE – 0 deg Trans

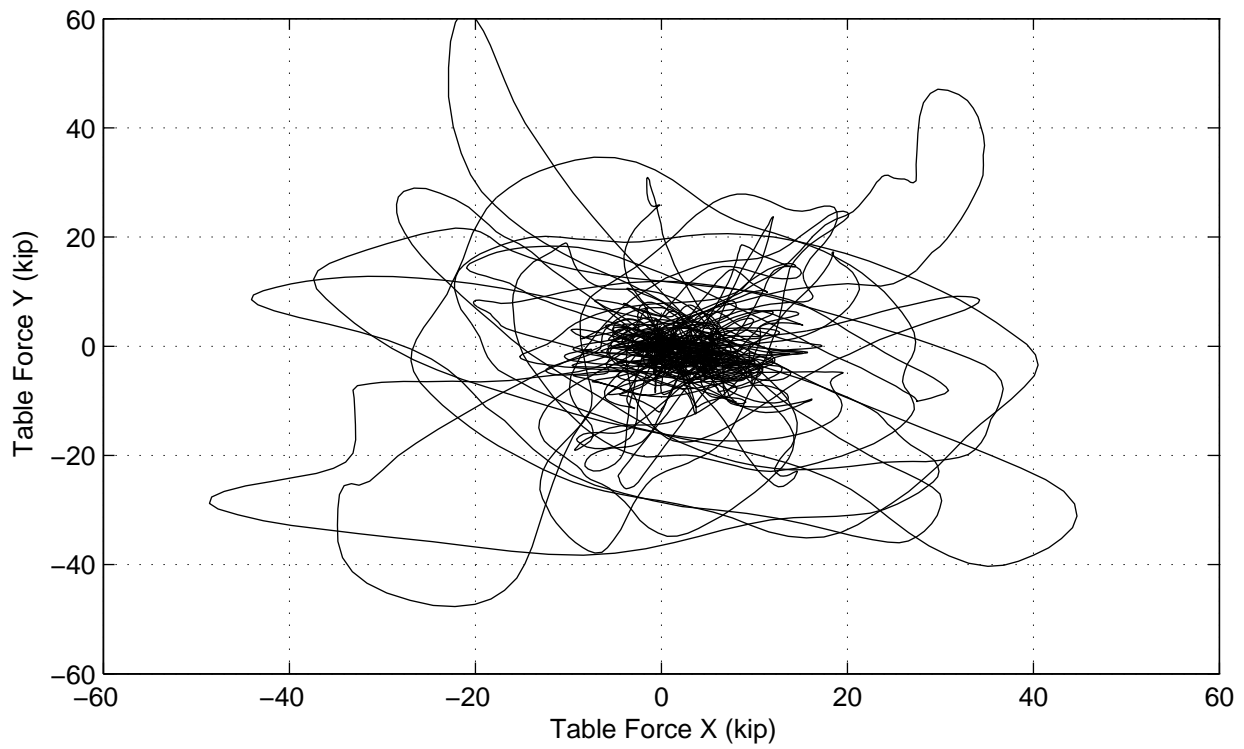
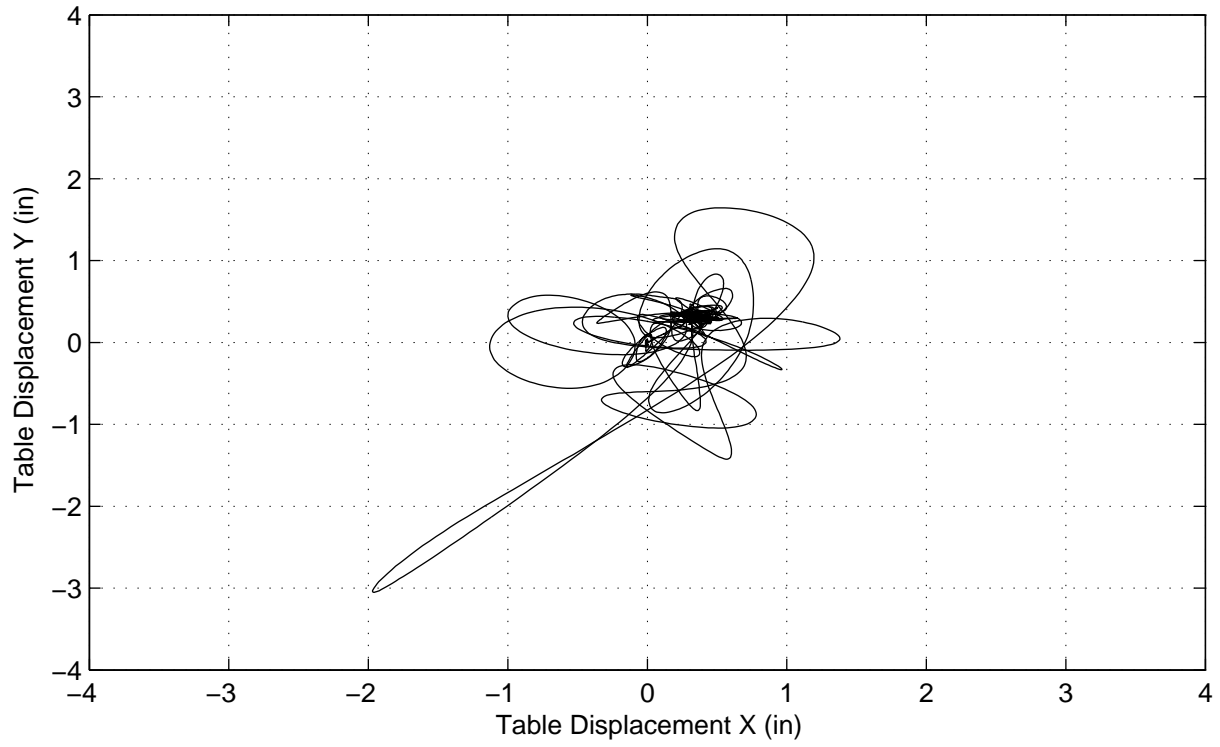

AP4 (Added Mass) – Test Q, 3.75in. Newhall MCE – 0 deg Trans

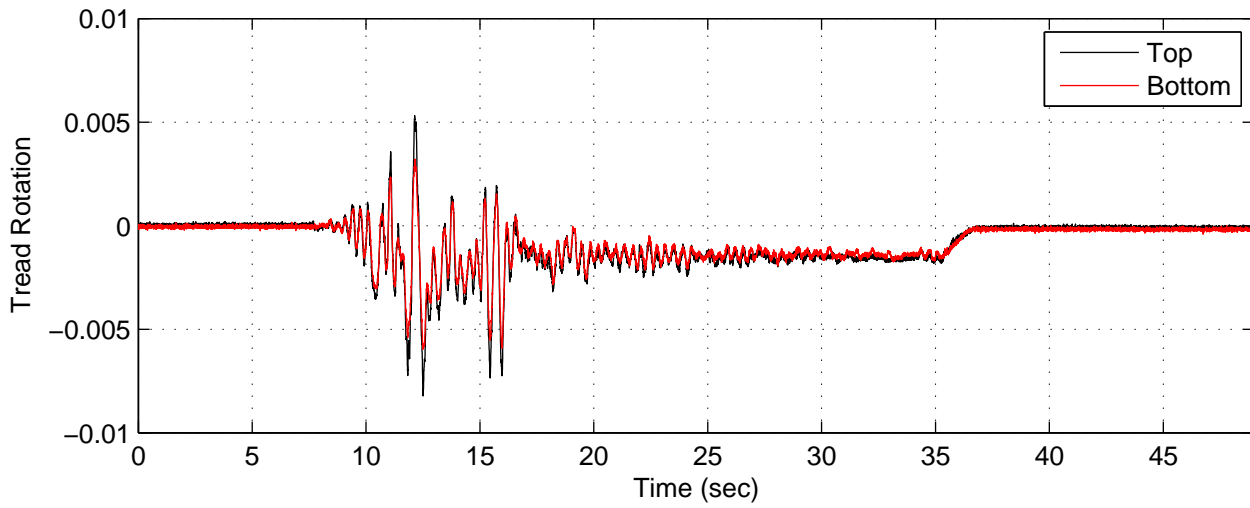
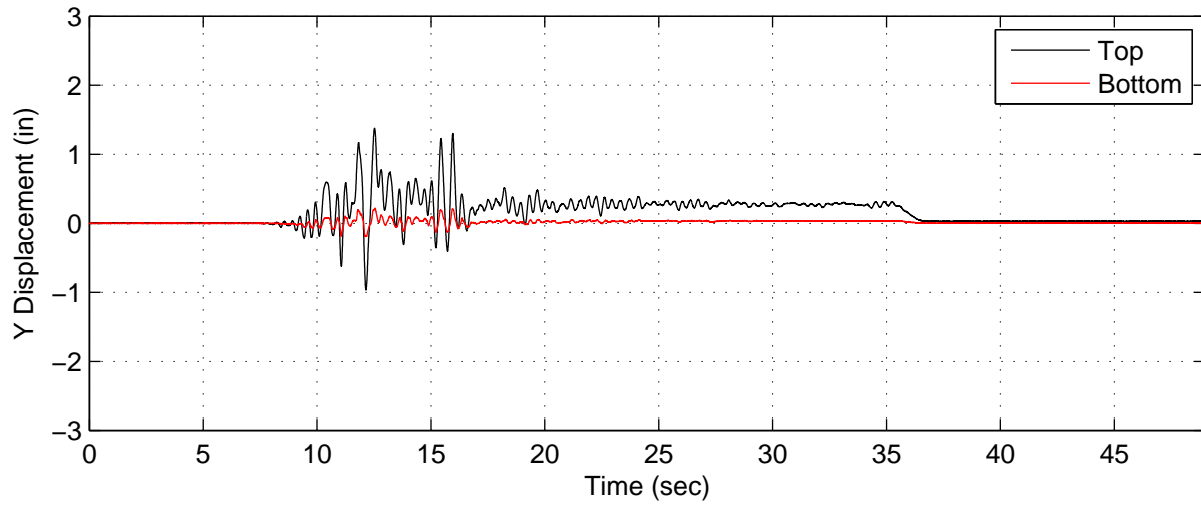
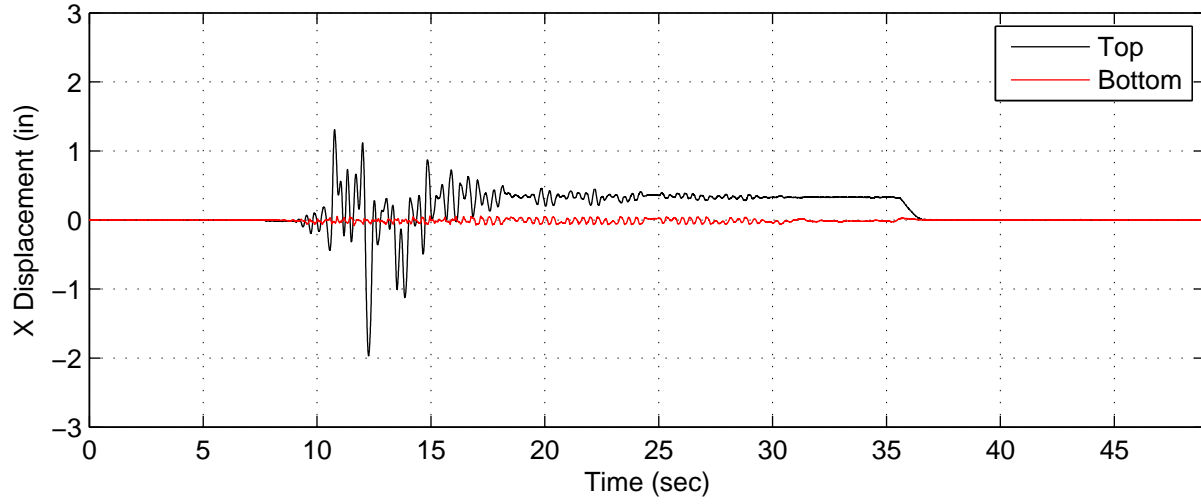

AP4 (Added Mass) – Test Q, 3.75in. Newhall MCE – 0 deg Trans

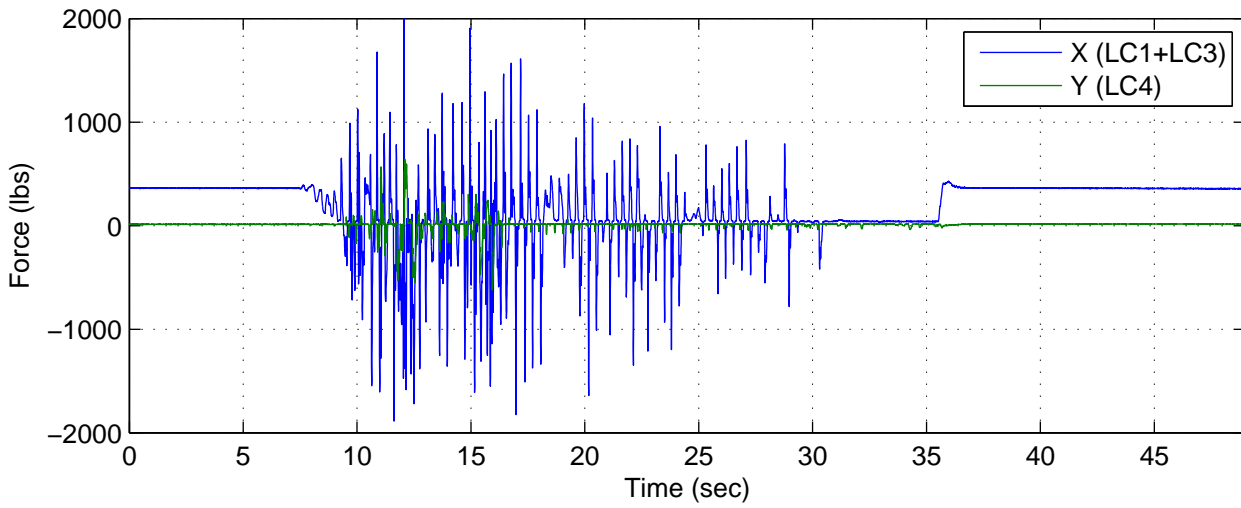
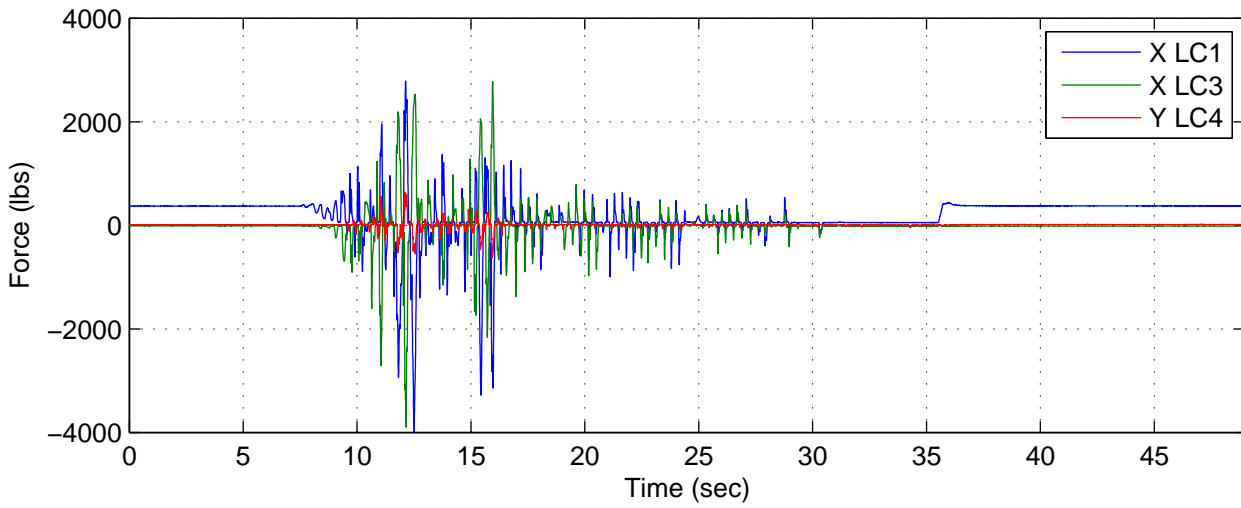
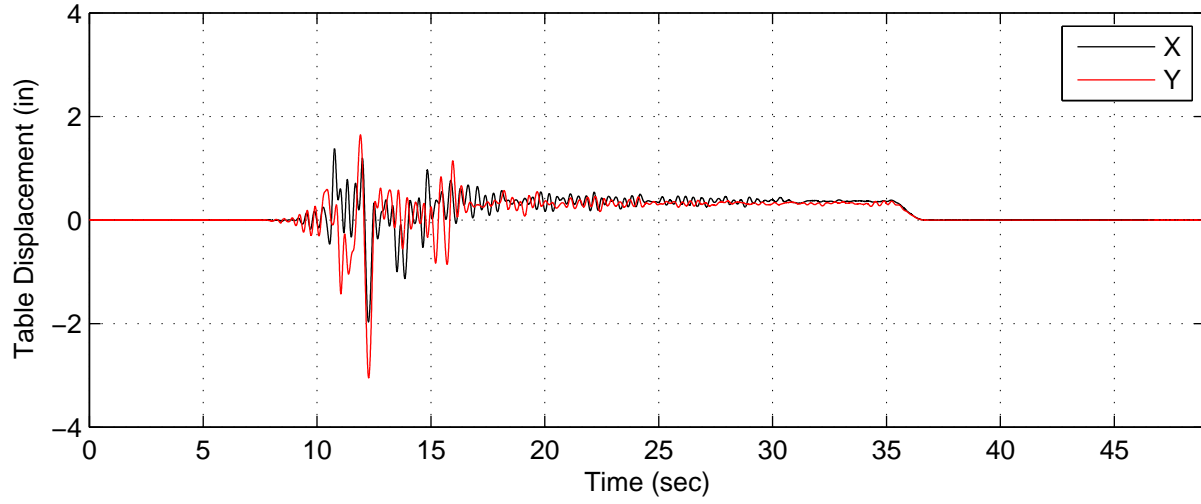

AP4 (Added Mass) – Test Q, 3.75in. Newhall MCE – 0 deg Trans

