

General Information

Open the pack list on the crate's exterior. Locate the shop drawings and installation instruction inside the box. Review contents and make sure all parts are present. For a rectangular installation, the pack list will include the number of modules and frame pieces. For odd-shaped installations, a drawing will be supplied identifying the module layout in numbered sequence.

If you discover that material is missing or defective, contact our customer service department immediately:
800.233.8493

Important Notes - Do Not Overlook

Prior to installation, ensure that the material is stored indoors and has acclimated to the environment's temperature for 24 hours.

Assess the site condition prior to installation ensuring the recess is:

- Free of debris and moisture
- The correct depth throughout
- Smooth and flat

High spots should be ground down. Low spots should be filled with a self-leveling grout. The side walls of the recess should also be checked for plumb and defects as this could affect the frame installation (if applicable). If these conditions have been met, you can begin the installation.

Prior to Final Installation

- Dry fit all materials to ensure proper module spacing and overall grid fit.
- Refer to the shop drawings for any required special/custom details or modifications.

Tools Required

You will need a level, hammer, a 5/32" bit, 1/8" bit, 3/8" bit, a 1/2" socket/wrench set, flathead screwdriver, #2 Phillips-head screwdriver, tape measure, carpenter's pencil or marker, shop vacuum, PPE (gloves, glasses, ear protection, etc.) and caulk gun.

Installation Instructions



1 Per the submittal drawings, a ledge should have been created by the concrete installer to install the perimeter frames and form a ledge for the GridLine units to rest upon.



2 Install the perimeter frame onto the ledge. Use the pre-drilled holes in the frame as a guide and drill into the ledge using a 5/32" drill bit. Fasten the frame using the supplied masonry anchor hardware.



3 Use shims if necessary.

To view details, specs and product info visit www.c-sgroup.com/efs.

For technical and design assistance call 800.233.8493

Installation Instructions (continued)



4 Begin the installation by installing the drain pans into the recess. Use a caulk gun to apply adhesive on top of the concrete surface throughout the entire recess.

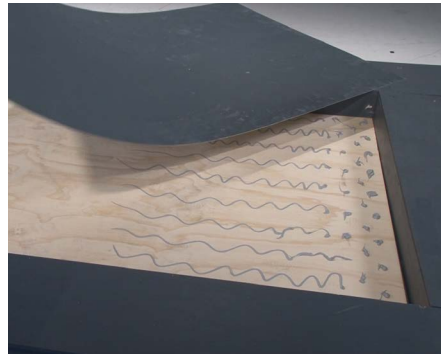

5 Place the pre-sized drain pan sheet(s) into the recess. Apply pressure evenly over the drain pan material to properly bond into the recess.



6 Use silicone caulking to caulk the recess' perimeter seams and any seam where multiple pan sheets abut.

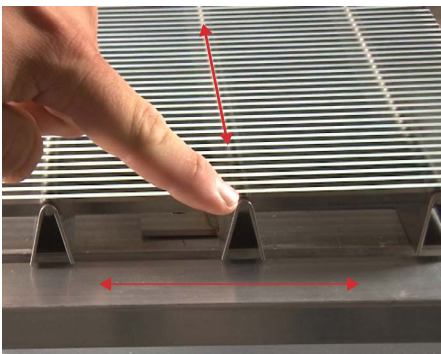

7 Install the intermediary supports throughout recess. These supports should be installed perpendicular to the support bars attached to the underside of the GridLine material.

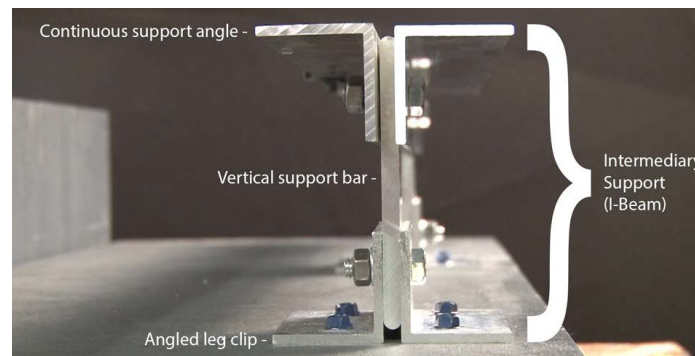

8 These supports are comprised of a series of continuous support angles and smaller angled leg clips that need to be assembled into a finished support system. They should be installed every 24" on center.

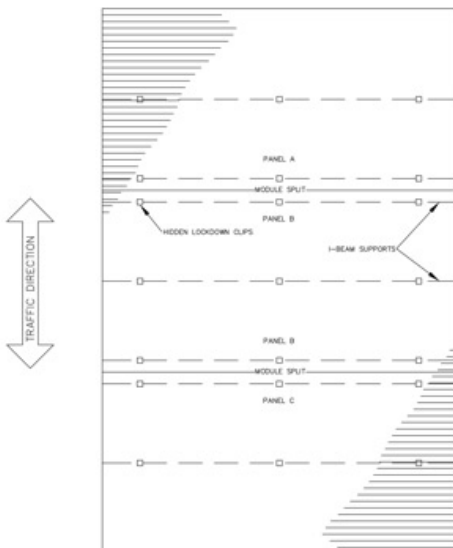

9 Use a tape measure to locate and mark all intermediary support locations in the recess. Support locations will be at all grid module splits and every 18" on center in between the module splits. Module splits are shown on the supplied shop drawings.

Installation Instructions (continued)

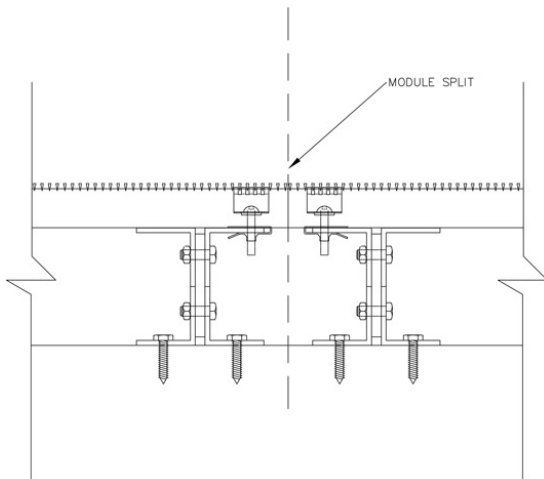

10 Two intermediary supports will need to be installed on each side of the module split location, as shown above.



11 At the module split locations begin by fastening angled clips every 24" along the continuous supports. Use a 5/32" drill bit to make a pilot hole through the pre-dilled holes in the angled leg clips.



12 Attach clips to the floor using a driver and the supplied masonry anchor hardware. Repeat at all angled clip locations. Be sure to install all clips facing the same direction.



13 Once intermediary supports are installed at all module splits, measure and install all remaining supports every 18" on center from the module split, in each direction.

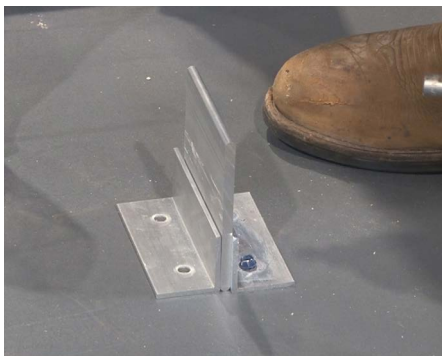

14 Place one vertical support bar against one of the installed angled leg clips. Place another angled leg clip, facing the opposite direction of the already installed angled leg clip and vertical support bar, creating an upside down T shape and sandwiching the vertical support bar.



15 Fasten that new angled leg clip to the floor using the supplied masonry anchors. Repeat at all anchor clip locations.



16 Place vertical support bars into every angled clip location.

Installation Instructions (continued)



17 At each clip anchor location use a 5/32" drill bit and drill a hole through both anchor clips and the vertical support bar.

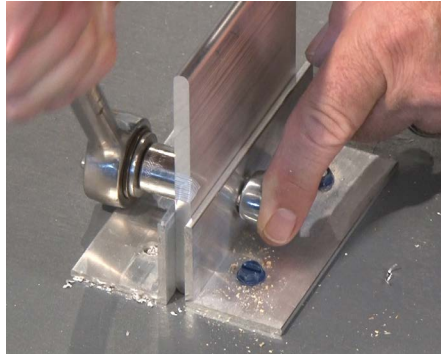

18 Use a 1/2" socket/wrench and the supplied nut/bolt hardware to fasten all three materials together.



19 Clamp one continuous support angle onto a vertical support bar. The angle should be positioned so one leg is tight against, and parallel with the vertical support bar. The other leg should be facing away from the vertical support bar. The top of this leg should be flush with the perimeter ledge frame.



20 Use a 5/32" drill and drill one pilot hole through the continuous angle and vertical support bar. Repeat this step at all other angled support clip locations.



21 Clamp another continuous support angle to the opposite side of the vertical support bar, creating an overall T-shaped support. Drill fastening holes in this angle utilizing the same hole locations previously drilled in the opposing angle.



22 Reinstall the continuous supports in the same T-shape with the vertical support bar located in between. Be sure the angle legs are flush with the top of the vertical support bar and that the drilled holes line up.



23 Using a socket/wrench and the supplied nut/bolt hardware, fasten the two continuous support angles to the vertical support bar. Repeat these steps at all angled clip locations.



24 All fully-assembled supports should be installed and flush with the perimeter ledge frame. Now it is time to begin locating the hidden lockdown clips.



25 Place the labeled GridLine panels on top of the intermediary supports as shown on the supplied shop drawings.

Installation Instructions (continued)

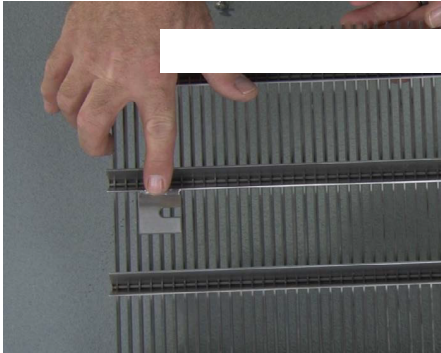

23 The lockdowns are already located and pre-installed on the grid module. Lockdowns are not required along the perimeter ledge frame.



24 Using a drill or center punch tool, transfer the marked lockdown location to the I-Beam support.



25 Remove the panels to access the supports underneath.



26 Using a 5/32" drill bit, drill through the support at the locations previously marked from above the panel.



27 Shown: Tinnerman clips

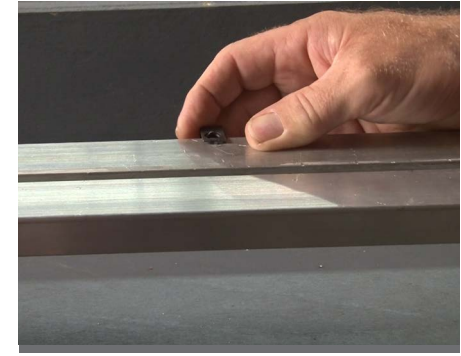

28 Install one Tinnerman clip at each drilled location along the supports.



29 Mount the screw into the welded tab. Use electrical tape to hold the screw in place.



30 Place the grid module with the installed clip/tab hardware into its corresponding Tinnerman clip location.

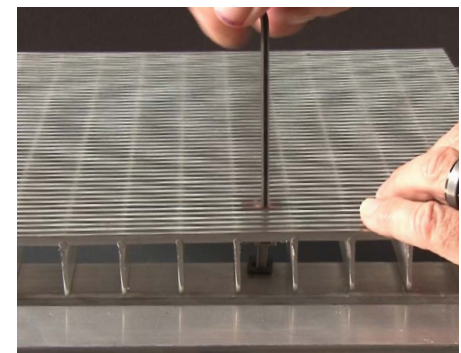

31 Be sure all screws are properly seated into the corresponding Tinnerman clips. Repeat these steps for all grid modules.

Installation Instructions (continued)



32 Beginning in the center and working your way out to the edges, **start** the screws with a 1/8" Allen wrench.

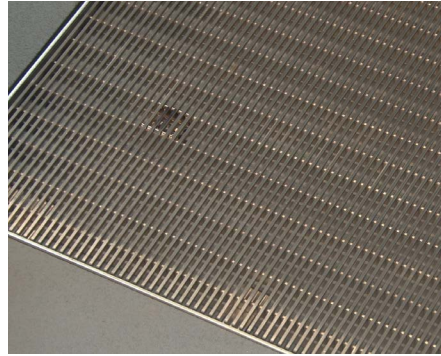

33 Go back to the center and lightly **draw down** the screws, working your way out to the edges.



34 Go back to the center and **tighten** the screws, working your way out to the edge. Repeat this process for the remaining modules.



35 If building construction is to continue, protect the grid with plywood sheathing.



36 Care & Maintenance: Once the installation is complete, use denatured alcohol to remove the marks on the grids and clean with a mop.