

# Acrovyn Wall Covering

## Supplemental Instructions

---

### ATTENTION

Inspect all materials for damage or missing parts. If you discover damaged or missing materials, in the USA please call 800.233.8493, and in Canada call 888.895.8955 for customer service.

Construction Specialties (CS) products must be installed in accordance with their respective instructions! Failure to follow the instructions may void any product warranties and result in an unsuccessful installation. For specific questions regarding installation of any CS product, in the USA please call 800.233.8493 or email [iwptechsupport@c-sgroup.com](mailto:iwptechsupport@c-sgroup.com). If in Canada, please call 888.895.8955.

For more information on CS products, visit our website at [www.c-sgroup.com](http://www.c-sgroup.com).

### IMPORTANT NOTES

1. The building environment where Acrovyn wall covering is being installed must always be climate controlled.
2. Ideal room temperature during installation is between 65°F and 75°F (18°C and 24°C), and the relative humidity is below 80%.
3. Room temperature after installation must always be maintained between 65°F and 75°F (18°C and 24°C).
4. Allow materials to acclimate to facility room temperature (minimum 24 hours) before beginning the installation.
5. Unroll sheets and trims immediately upon receipt if they were shipped to you rolled. Storing them rolled will result in them not lying flat for installation.
6. If the quantity of sheets to be installed in a specific area is 25 or more, break the stack down to a maximum of 25 sheets.
7. Shipment may contain more than one lot number, as noted on the back side of the sheets. Sort and install accordingly. Failure to do so may result in shade variations.
8. Don't expose wall covering to ultraviolet light sources, as this could cause fading and/or color variations.
9. Don't expose wall covering to elevated temperature or direct sunlight after installation. This causes the surface temperature to rise, which will cause bubbles and delamination.
10. Acrovyn wall covering will expand and contract with changes in temperature. Thermal movement of the Acrovyn will change in size by .00005" per inch / per degree (see thermal movement chart on last page). If the temperature is expected to vary more than 20°F (11°C), please contact us before beginning the installation.
11. Acrovyn wall covering is not to be installed on ceilings due to higher temperatures and lack of bracing until adhesive fully cures.
12. Pick-proof caulk (provided by others) is acceptable for use with Acrovyn sheet only if interior temperature fluctuation remains within +/- 5 degrees during and after installation. Cured ColorFlex II<sup>®</sup> has a Shore A value of greater than 55 (product considered "pick-resistant" based on industry standards); testing conducted by independent lab in accordance with ASTM C661 and ASTM C920.

13. Cove base and cove base adhesive are supplied by others. Compatibility of base adhesive with Acrovyn should be referred to base adhesive manufacturer.
14. Using adhesives other than those provided by CS will void the fire rating and warranty.
15. Make sure all materials are stored indoors and are kept flat in a clean and dry area before acclimating them. Material should be well supported, and the temperature should be minimum 40°F (4°C) and maximum 100°F (38°C).
16. Make sure porous substrates like drywall or concrete block are sealed with primer before adhesive application.
17. Wipe the back of the wall covering with a clean, damp cloth to remove any dust or dirt just before installing.
18. If using adhesive to install wall covering
  - a. Don't use polyvinyl (PVA) based primers in conjunction with Acrovyn Interiors Water Based Mastic.
  - b. Don't dilute Acrovyn Interiors Water Based Mastic with water or solvent.
  - c. Apply adhesive to the wall surface only.
  - d. Allow the adhesive to cure properly. Under ideal conditions, curing time will be approximately 30 minutes. However, it will vary depending on temperature and relative humidity. The adhesive cure time for applications over nonporous substrates is critical and will also vary.
  - e. Remove excess adhesive immediately. Dried adhesive is to be removed from tools using paint thinner or a similar solvent.
  - f. Don't use methyl ethyl ketone (MEK), cleaners containing MEK or similar solvents, Scotch-Brite pads, steel wool, or similar cleaning pads to clean Acrovyn wall covering.
  - g. Refer to the MSDS for disposal of extra adhesive and primer.
19. Don't butt wall covering tight against doorjambs, ceilings, or baseboards. Allow a 1/16" (1.6mm) gap for expansion.
20. Drill/cut oversized holes when installing fixtures such as handrails, air ducts, etc. If another contractor is to install these items, be certain to notify them that oversized holes are necessary.
21. All Acrovyn sheet cuts can be performed by using electric shears, a spiral saw, or a utility knife. Several cuts will be required to cut completely through if utilizing a utility knife.

THERMAL MOVEMENT CHART					
SHEET WIDTH	EXPECTED GROWTH FOR VARIOUS TEMPERATURE CHANGES				
	+/- 5°F (3°C)	+/- 5.1°F (3°C)	+/- 10°F (6°C)	+/- 15°F (8°C)	+/- 20°F (11°C)
4' – 0"	OK TO BUTT	1/64" (.39mm)	1/32" (.79mm)	1/32" (.79mm)	3/64" (1.19mm)
8' – 0"	OK TO BUTT	1/32" (.79mm)	3/64" (1.19mm)	5/64" (1.98mm)	3/32" (2.38mm)
10' – 0"	OK TO BUTT	1/32" (.79mm)	1/16" (1.59mm)	3/32" (2.38mm)	1/8" (3.17mm)
12' – 0"	OK TO BUTT	1/32" (.79mm)	5/64" (1.98mm)	7/64" (2.78mm)	9/64" (3.57mm)

# Acrovyn Wall Covering

## ATTENTION

Please read these instructions thoroughly prior to beginning **ACROVYN WALL COVERING** installation.

This instruction sheet is intended to provide a specific guide to follow for the installation of **ACROVYN WALL COVERING**. Contained within is the technical information and installation techniques required to complete an efficient, neat, and long-lasting installation.

See "**WALL COVERING** – Supplemental Information" sheet for additional notes and other helpful installation tips.

## STORAGE

Make sure all materials are stored indoors and are kept flat in a clean and dry area before acclimating them. Material should be well supported, and the temperature should be a minimum of 40°F (4°C) and a maximum of 100°F (38°C).

## INSTALLATION INSTRUCTIONS

### TOOLS AND EQUIPMENT

#### SUPPLIED BY CONTRACTOR

Chalk line  
6'-0" level (or larger)  
Straight edge  
Drop cloth  
Masking tape  
Utility knife  
Water bucket  
Mild detergent  
Caulk gun  
Electric shears  
Spiral saw  
Paint tray & roller (if using primer)

#### SUPPLIED BY CONSTRUCTION SPECIALTIES (CS)

**ITEMS BELOW MUST BE USED AT TIME OF INSTALLATION FOR LIMITED LIFETIME WARRANTY TO BE AWARDED.**

1/8" V-notch trowel  
Acrovyn Interiors Heavy Duty Water Based Mastic Adhesive, Acrovyn Caulk, or Trims  
Primers (if required) (coverage: 350 - 400 ft<sup>2</sup>/gal)  
CS primer is free of PVA (poly vinyl acetate). Primers containing PVA are highly discouraged, as chemical properties in PVA could have adverse effects on adhesive during and after installation.

#### OPTIONAL KIT INCLUDES (IF PURCHASED SEPARATELY)

Crain #333 extension roller (95W010000)  
1/8" V-notch trowel (95W017000)  
Putty knife (95W003000)  
Utility knife (95W007000)  
Sponge pad (95W011000)  
Scissors (95W008000)  
Compass (95W009000)  
2" Paint Brush (95W004000)  
Paint Kit (95W001000)

#### Alternate UL® Approved Spray-Lock® FRP Adhesive

Spray-Lock FRP adhesive is covered under CS factory warranty as long as it is supplied directly from CS.

Acrovyn By Design® and 0.075" thick Acrovyn sheet applied using Spray-Lock FRP is not UL approved and is not covered under the CS factory warranty.

## WALL PREPARATION

Examine all new or existing walls that are to receive Acrovyn wall covering. They must be clean, smooth, dry, and free of any oils or loose paint prior to applying primer.

## SPECIFIC CONDITIONS

**New Drywall or Plaster:** New drywall should be taped and sanded smooth. Minimum Level 3 wall finish is required; for surfaces with Level 5 finish, ensure the surface and any surface coatings are fully dry and cured. When finished, all surfaces should be wiped clean to remove any dust. New plaster should be allowed to cure a minimum of 30 days.

**Particle Board, Plywood or MDF:** New particle board, plywood or MDF should be smooth and all surfaces should be wiped clean to remove any dust to allow for best adhesion.

**Concrete & Concrete Masonry Units:** Only .060"-thick Acrovyn is suggested for use over concrete and CMU wall because the unevenness of the wall will telegraph through thinner Acrovyn wall covering. All concrete or CMU walls should still be made smooth with a coating of spackling compound or a thin set mortar. **Note: CS strongly suggests that a test area be done to ensure desired adhesion is achieved. All adhesive testing is the responsibility of the contractor on-site.**

**Painted Surfaces:** Painted surfaces must be tested for adhesion. Apply a 12" x 12" piece of Acrovyn in an inconspicuous area. After allowing the sample to set for 24 hours, remove the test piece and examine the area. If the paint has softened where the adhesive was applied, the paint must be removed or sealed with primer. If the walls are drywall, test over a joint compound location if possible.

**Existing Wall Coverings:** When installing over existing materials like wallpaper or vinyl wall covering, the entire surface must be inspected for areas that are not securely bonded to the wall surface. Any loose areas must be removed and repaired as required. The existing wall covering should then be cleaned with a mild detergent and wiped dry. Be certain all cleaned areas are completely dry before proceeding. **Note: CS strongly suggests that a test area be done to ensure desired adhesion is achieved. All adhesive testing is the responsibility of the contractor on-site.**

**Ceramic Tile:** Only .060"-thick Acrovyn is suggested for use over existing ceramic tile. Inspect the bond and surface condition of the tile to be sure it is suitable for sheet installation. If the tile bond and surface is not adequate, scuffing the tile to remove the glossy surface glazing may improve the bond to an adequate level. If the bond is still not adequate, the ceramic tile should be removed, and the wall surface repaired as required.

Apply joint compound to eliminate all evidence of the tile joints and then apply primer. Once all surfaces have been made smooth, complete the installation according to the CS installation instructions. **Note: CS strongly suggests that a test area be done to ensure desired adhesion is achieved. All adhesive testing is the responsibility of the contractor on-site.**

**Note: For all other conditions, CS strongly suggests that a test area be done to ensure desired adhesion is achieved. All adhesive testing is the responsibility of the contractor on-site.**

### Radius Sheet Guidelines:

All of the material can be installed, following our standard installation instructions, using our mastic adhesive. Additional bracing, strapping, or other means of applying pressure inward, toward the column, may be necessary to keep in position, until mastic fully cures. When the radius diameter requires contact cement (as noted in manufacturer radius guidelines) 3M Fastbond Contact Adhesive is the recommended adhesive. It should eliminate the need for strapping of any kind, until the adhesive cures. Follow the instructions on the adhesive and scuff the rear of the sheet to allow for better adhesion.

## STEP 1: GRAIN DIRECTION AND PREVENTATIVE MEASURES

Because Acrovyn has a grain direction, all material should be installed with the same top and bottom orientation. To ensure consistent orientation, always refer to the ink jet printed arrow on the reverse side of the sheet. Always install the sheet with the arrow in a consistent direction.

To ensure easy cleanup and/or prevent damage to adjacent finishes, use a drop cloth at the base of the walls, mask door and window frame edges and remove all cover plates, like switches, outlets and thermostat covers.

**Acrovyn by Design®:** In order to maintain pattern alignment and ensure layout, it is important to dry fit all sheets prior to installation. If installing custom designs, refer to drafting details for layout references.

## STEP 2: WALL PRIMING

**New Drywall or Plaster:** Walls must be sealed/primed using CS-supplied water-based primer. A bond test should be performed prior to installation to verify walls are sealed/primed adequately.

**Painted Drywall or Plaster:** Painted walls must be checked for adhesion as described under the wall preparation section. If the paint will not provide an acceptable base for adhesion, all areas must be removed and primed with primer.

**Concrete, Concrete Block, Wood Paneling, Plywood, Particle Board, MDF or Similar:** These surfaces must be made smooth with a coating of spackling compound and then primed with primer. CS suggests that all surfaces be checked for adhesion.

**Flexible or Rigid Wall Covering over Drywall or Plaster:** Existing wall covering must be clean and their installation must be secure before installing Acrovyn wall covering. Priming is not necessary for these surfaces.

**Acrovyn by Design®:** Tinted primers can be used at sheet seam locations to match the graphic colors. Doing this in conjunction with applying clear caulk later could help make sheet joints less visible.

## STEP 3: STARTING PROCEDURES

Note: Bottom of sheet should be installed no less than 1" (25.4mm) recommended above finish floor for field variation.

**Full-Height Installation:** Establish a plumb line to be located at the edge of the first sheet. This will serve as a starting point for the wall covering to be installed on that wall and will ensure the following sheets will be installed plumb. Establish a plumb line at the beginning of each new installation of wall covering.

**Wainscot Installation:** Establish a level line at the specified height for the entire length of the run. Install the wall covering by aligning the top edge with this line. A level line should be established for each new installation.

## STEP 4: SHEET PREPARATION

Prepare the first sheet by making any necessary cutouts or scribe the edge to fit the inside corner if applicable. Remember to allow a 1/16" gap around door and window frames, ceilings and baseboards. Use a straight edge to ensure neat cutouts. Place the sheet with the smooth side up and wipe the sheet with a clean, damp cloth to remove any dust or dirt.

**Acrovyn by Design®:** Trimming of sheets, if required, should be done at the beginning and the end of a run only to ensure pattern alignment on standard patterns only. Custom images should be cut and trimmed as noted on the submittal and F&F drawings. All necessary cutouts should be performed as previously described in these instructions. Do not damage the back of the sheet, as it could cause damage to the printed imagery.

**Acrovyn by Design® Tapestry Collection:** Some cutting methods do not cleanly cut the imbedded fabric of the material and can cause small loose fibers to be exposed along the cut edge. If this occurs, it is recommended to sand the side of the sheet with sandpaper that is a minimum of 220 grit. Do not damage the back of the sheet, as it could cause remove the opaque backer.

## STEP 5: ADHESIVE APPLICATION

Use the supplied 1/8" V-notch trowel to apply Acrovyn Interiors Heavy Duty Water Based Mastic Adhesive to an area of the wall surface that can be completed within the cure time of the adhesive. The 1/8" V-notch trowel must be used to maintain the warranty and fire rating by ensuring proper glue coverage. Make sure the entire area receives an even coat. **DO NOT ALLOW THE ADHESIVE TO OVERCURE!**

When applying the adhesive to the wall, the trowel must be held as close to perpendicular, or 90 degrees, to the wall as possible. Angles less than perpendicular reduce the amount of adhesive for proper installation and may result in delamination.

Be certain the trowel notches are cleaned regularly. Allowing the notches to fill with dried adhesive will reduce the application, which will cause failures because of inadequate adhesive. The projected coverage using the 1/8" V-notch trowel is 125 ft<sup>2</sup> / gal. Occasionally check the adhesive coverage to ensure the correct amount is being applied under ideal conditions, the proper cure time of the adhesive should be approximately 30 minutes but could be up to 2 hours. However, this time will vary depending on temperature and relative humidity. The use of fans for air movement may help reduce the adhesive cure time. A dehumidifier may also be used in high-humidity conditions to help reduce cure time. When applied, the adhesive is white and creamy. As it cures, the adhesive will become translucent and tacky. In a porous substrate application, it is best to install the wall covering when the adhesive has cured approximately 75% or when it becomes tacky and does not transfer onto your finger.

Nonporous surfaces like metal, high-pressure laminate or vinyl will not absorb moisture from the adhesive, thus retarding its cure time. It is important that the adhesive is firm, yet pliable, to the touch and that it does not transfer onto your finger. If the wall covering is installed before the adhesive has reached this stage, the moisture released by the curing adhesive will become trapped, and at elevated temperature the wall covering will bubble and/or delaminate.

Once the adhesive has cured properly, the wall covering can be installed.

Optional Spray-Lock® FRP Adhesive Installation: For proper installation follow instructions supplied on can of the adhesive. For additional information and installation video visit [www.spraylock.com](http://www.spraylock.com). Note: Spray-Lock FRP Adhesive is not covered under CS factory warranty unless it is factory supplied by Construction Specialties.

## STEP 6: HANDLING AND INSTALLATION

Careless handling of Acrovyn wall covering could result in damage and unrepairable "kink" marks. Damage is less likely to occur when using two people to move and position the sheets.

Align the edge of the wall covering with the plumb or level line established in step 3 and rub the wall covering along the edge no closer than 6" (152.4mm) from that edge (to allow for positioning of vertical trims). Continue this procedure over the full length of that edge of wall covering until it has been aligned. Lightly rub the rest of the wall covering until the rest of its area has made contact with the wall surface. Sheets can be repositioned as long as they are not pressed firmly into the mastic adhesive.

**IT IS IMPORTANT TO REMOVE ANY EXCESS ADHESIVE WITH SOAP AND WATER BEFORE IT CURES AND BECOMES MUCH MORE DIFFICULT TO REMOVE.**

## STEP 7: TRIM APPLICATION

When required, install the vertical trim after the first sheet is in place but before the smoothing operation. It is necessary to notch the back of all Acrovyn vertical trims where they intersect the wainscot trim (included inside/outside corner; see page 7 for rabbet detail). For aluminum trims, there is a die line on the back of the trim that could be used as a reference point to notch the back leg to when intersecting another trim. Wherever a vertical trim will intersect a wainscot trim, mark the location on the wainscot trim and then notch out the back leg up to the die line. See the trim notch detail at the bottom of page 8. After cutting or notching aluminum trims, be sure to deburr cut edges with a fine file. Attach the trim to the edge of the abutting sheet and align with the edge of the previously installed sheet, making sure that the trim overlaps both installed sheets. **DO NOT INSTALL THE TRIM TIGHT AGAINST THE SHEET EDGE—ALLOW TOLERANCE TO ACCOMMODATE THERMAL MOVEMENT.** Use a roller to ensure the trim makes contact with the adhesive and wall surface.

Wainscot trim is installed much the same way as vertical trim. If notching the wainscot trim to accept vertical trim, it must be done prior to installing the wainscot trim. If aluminum wainscot trims are being installed with full-length corners, the corners should be notched in the same manner as the wainscot was, but at any point where the wainscot intersects the corners.

**Note:** Trims can be mitered in the corners if picture framing or if vertical and horizontal are intersecting.

## STEP 8: SMOOTHING OPERATION

Once the Acrovyn sheet has been aligned with the plumb line or adjacent sheet, use a roller to ensure maximum contact with the CS Water Based Mastic Adhesive. With the roller, start in the middle of the sheet and work toward the top, bottom and edges using full-width strokes in an arching motion. By smoothing the sheet, you will also be able to remove any trapped air pockets. Once completed, run the palm of your hand over the entire surface, feeling for bubbles or loose areas. Repeat the smoothing process as necessary until the entire sheet makes full contact with the adhesive.

## STEP 9: ABUTTING SHEETS

**Vertical Trims:** When specified, install vertical trims as described in step 7. The next sheet should be installed by inserting the adjacent edge into the vertical trim that's been installed previously. Insert the corner of the adjacent sheet into the vertical trim and gradually work along the length of the trim until the wall covering is in position. Note: If using aluminum vertical trims, it is necessary to rabbet 5/32" (3.9mm) off the back side of the trim. See rabbet detail on page 7.

**Butt Joints:** Butt joints should only be used in temperature-controlled environments of 75°F +/- 5°F (24°C +/- 3°C) during and after the installation. If the temperature is expected to exceed this, please refer to the thermal movement chart on page 3 of the Wall Covering Supplement document to determine the appropriate joint spacing.

**Color-Matched Caulk:** CS has caulk that matches the specified sheet color and can be purchased separately for use at wall covering joints. When caulked joints are specified, a gap is required between sheets. Refer to the thermal movement chart on page 3 of the Wall Covering Supplemental document to determine the appropriate gap width, **BUT DO NOT MAKE THE GAP LESS THAN 1/16" (1.6mm) WIDE.**

Before applying caulk, mask each edge of the joint with masking tape to protect the wall covering from excess caulk. Once the joints have been masked, apply a bead of the color-matched caulk to the joint. Coverage equals 90 – 100 feet per tube. Wait 4 hours before removing the tape.

In certain applications, a second coat may be required. Please follow the same installation procedure when applying the second coat. Allow a minimum of 4 hours to cure before applying the second topcoat.

**STEP 10: CORNER CONDITIONS**

At inside and outside corners, cut the Acrovyn wall covering to correct width minus 1/16" (1.6mm) to facilitate the installation of the inside or outside corner trim. Dry fit the sheet with the trim attached to ensure proper alignment or fit. Once satisfied with the fit, apply the adhesive as noted in step 5. Align the sheet edge with the adjacent piece and roll it toward the inside or outside corner.

Note: It is necessary to notch the back of the corner trim where it intersects the wainscot trim.

**STEP 11: CLEANUP**

Upon completion of the installation, remove all protective materials (masking tape, etc.) except for the drop cloths. Inspect all joints and cutouts to ensure that all excess adhesive has been removed. Use soap and water to clean any areas that may have adhesive residue. Once the inspection and cleanup have been completed, the drop cloths can be removed, and the cover plates and other wall-mounted items can be installed.

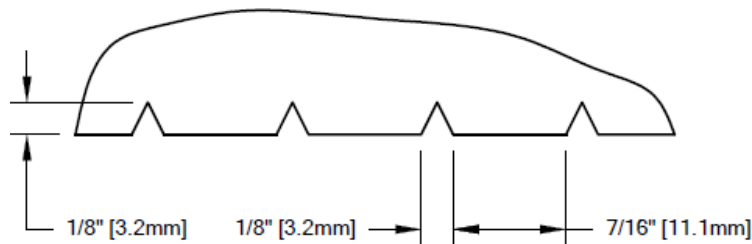

**Trowel Details**

Special 1/8" V-notch trowel for use with Acrovyn wall covering.

Projected adhesive coverage using this trowel is 125 square feet/gallon.

**DO NOT SUBSTITUTE!**

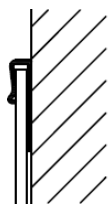

**Wainscot Trim**

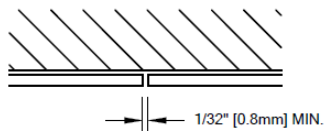

**Standard Vertical Joint**

Refer to thermal movement chart for proper spacing.

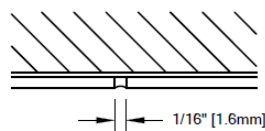

Optional Joint  
**Color-Matched  
Caulk**



Optional Joint  
**Vertical Trim**



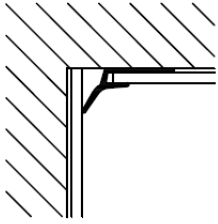

**Inside Corner Trim**

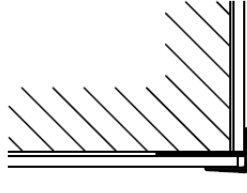

**Standard Outside Corner Trim**

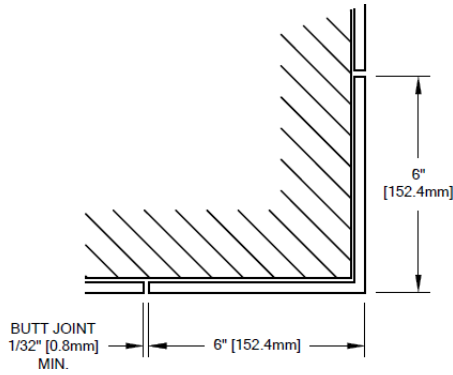

**Formed Outside Corner Trim**

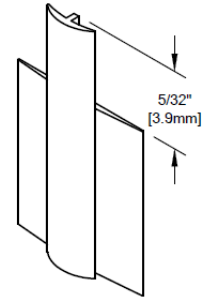

**Rabbet Detail**  
Metal vertical trim shown.  
Metal inside/outside corner trims also to be rabbeted.

**ACROVYN TRIMS**

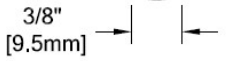

**Vertical Trim**  
(25N033xxxS, for .040/.060" sheet)  
(25N038xxxS, for .075" sheet)

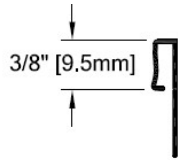

**Wainscot Trim**  
(25N036xxxS, for .040/.060" sheet)  
(25N040xxxS, for .075" sheet)

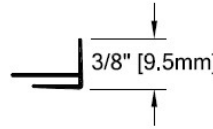

**Outside Corner Trim**  
(25N032xxxS, for .040/.060" sheet)  
(25N037xxxS, for .075" sheet)

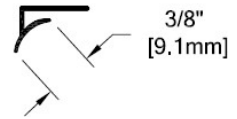

**Inside Corner Trim**  
(25N035xxxS, for .040/.060" sheet)  
(25N039xxxS, for .075" sheet)

**FLAT ALUMINUM TRIMS**

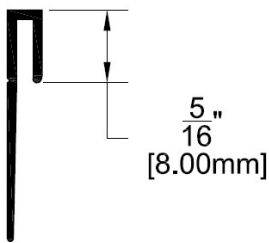

**Wainscot Trim**  
(25A023XXX)

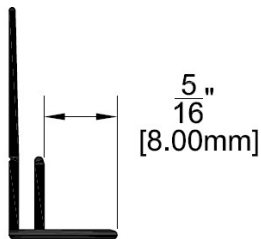

**Inside Corner Trim**  
(25A024XXX)

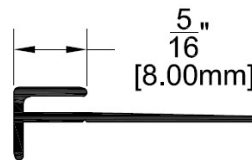

**Outside Corner Trim**  
(25A025XXX)

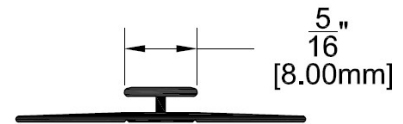

**Vertical Trim**  
(25A022XXX)

RADIUS ALUMINUM TRIMS

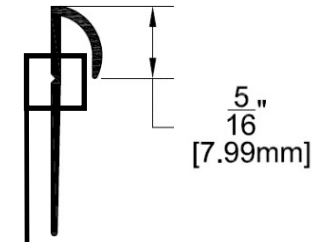

**Wainscot Trim**  
(25A031xxx)

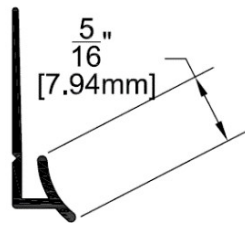

**Inside Corner Trim**  
(25A032xxx)

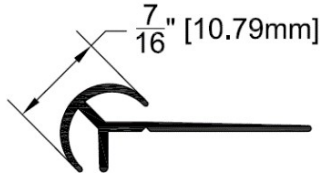

**Outside Corner Trim**  
(25A033xxx)

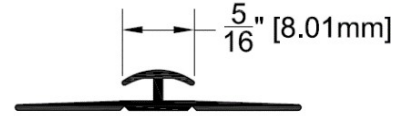

**Vertical Trim**  
(25A034xxx)

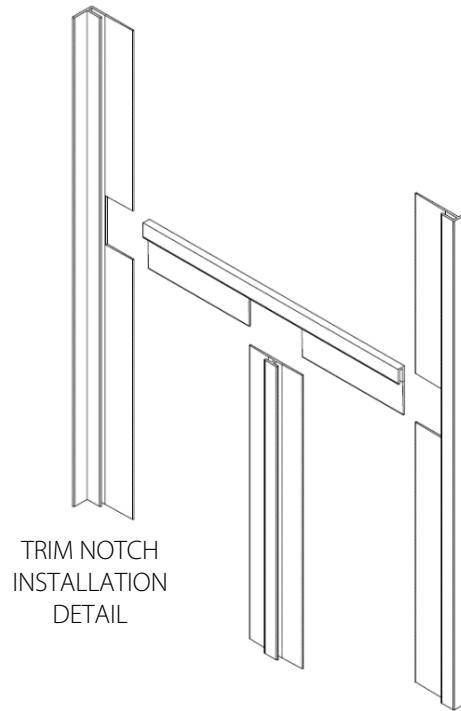

Note: Aluminum trims are available only for .040" and .060" sheet.