

**COLOR:**  
**DOOR LEVER HANDLE PROTECTOR:** \_\_\_\_\_  
 COLOR TO BE SELECTED FROM ONE OF CS STANDARD COLORS.

DOOR # / MARK #	UNITS REQ'D	L (LEFT) OR R (RIGHT) CIRCLE ONE
		L / R
		L / R
		L / R

**NOTE:**  
 1. LEFT HAND SHOWN, RIGHT HAND OPPOSITE

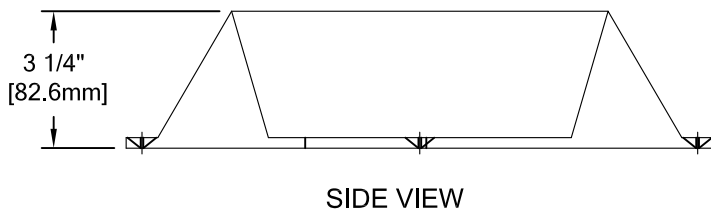
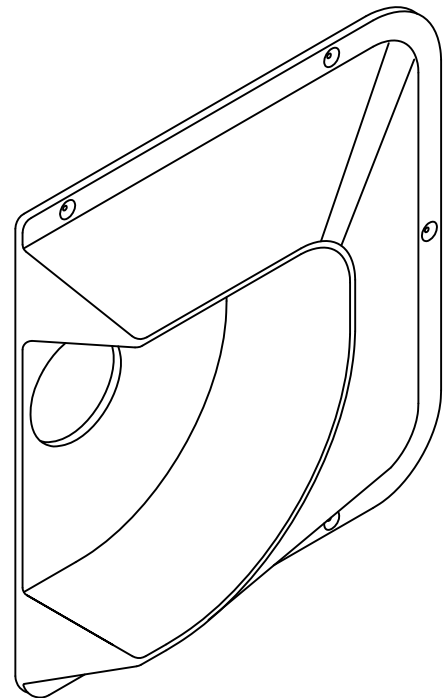
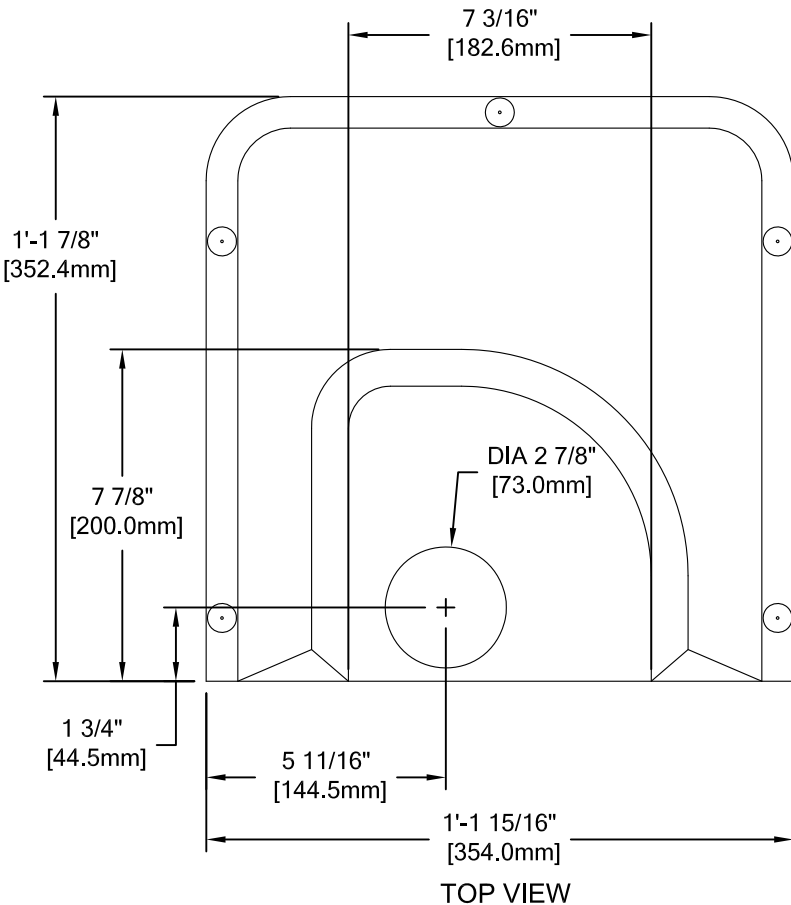

# DNP-7 ACROVYN 4000

CONDITION	SPECIFIED FASTENER	DRILL DIAMETERS	CS PART NUMBER
		DOOR	
HOLLOW METAL WOOD	1-3/4" LONG ALUMINUM SCREW POST 1/2" LONG FLAT HEAD MACHINE SCREW (SLOTTED)	7/32"	90H016010

 Hughesville, PA   800.233.8493   570.546.5941 Mississauga, ON   888.895.8955   905.274.3611 <a href="http://www.c-sgroup.com">www.c-sgroup.com</a> © Copyright 2016 Construction Specialties, Inc.	<b>PROJECT:</b>	<b>REVISION:</b>
	<b>JOB NO.:</b>	<b>F&amp;F:</b>
	<b>CUSTOMER:</b>	
	<b>REP:</b>	<b>DATE:</b>
	<b>DRAWN BY:</b>	<b>SHEET NO:</b>