

WALL PANEL FABRICATION SCHEDULE

PANEL COLOR	PANEL SIZE (V X H)	REVEAL TYPE (A-C)	REVEAL WIDTH (IF APPLICABLE)	REVEAL COLOR <sup>1</sup>

NOTES:

1. SHEET REVEAL COLOR IS TO BE ONE OF CS STANDARD ACROVYN COLORS. PAINTED WALL REVEALS ARE TO BE DONE BY OTHERS.

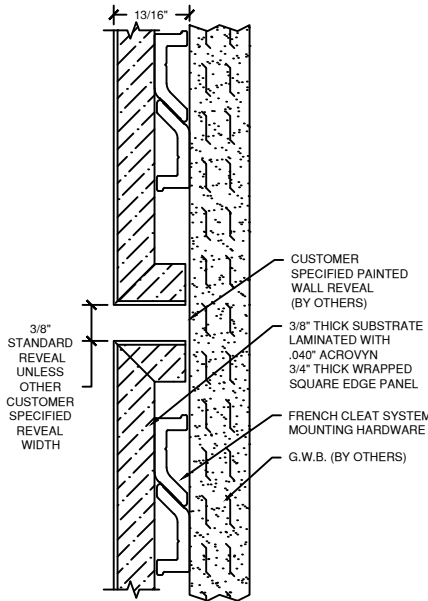

(A) PAINTED WALL REVEAL CONDITION

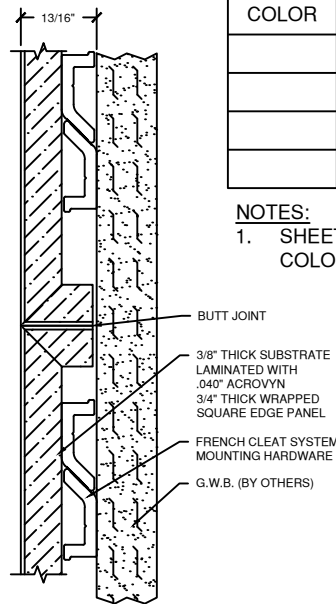

(B) BUTTED PANEL CONDITION

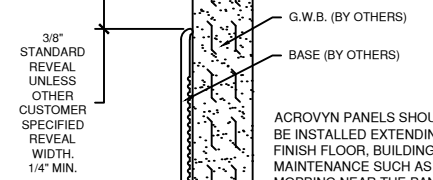
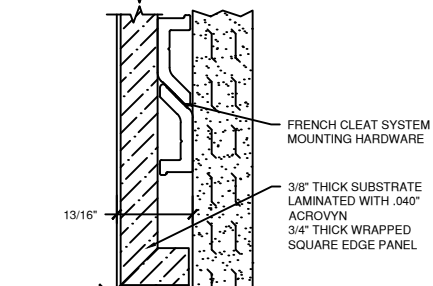
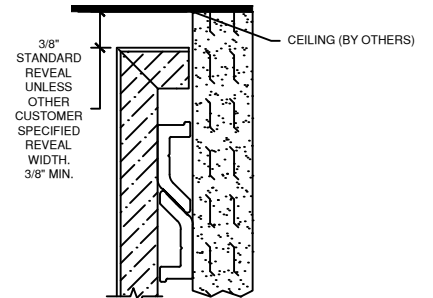

ACROVYN PANELS SHOULD NOT BE INSTALLED EXTENDING TO THE FINISH FLOOR, BUILDING MAINTENANCE SUCH AS WET MOPPING NEAR THE PANELS COULD CAUSE THE PANELS TO "WICK" UP MOISTURE. CS WALL PANELS ARE NOT INTENDED TO BE USED IN AREAS WHERE MOISTURE COULD COME IN CONTACT WITH PANELS.

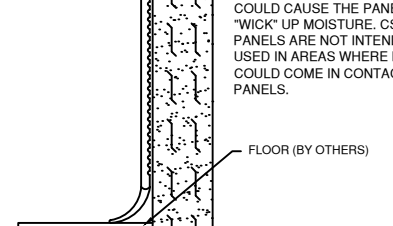

BASE AND CEILING CONDITION

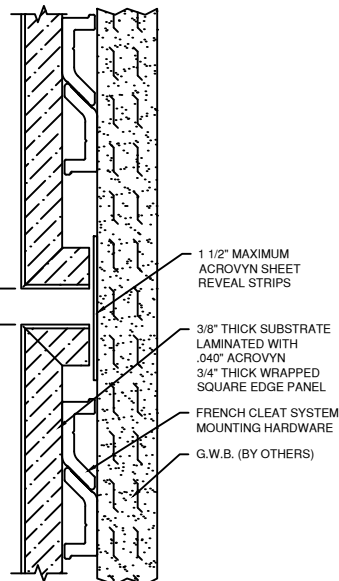

(C) ACROVYN SHEET REVEAL STRIP CONDITION

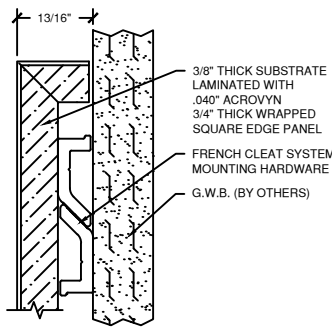

WAINSCOT CONDITION

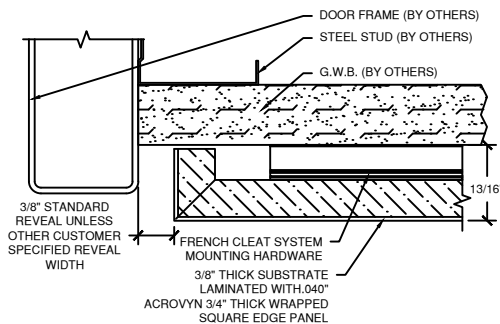

END WALL CONDITION

# CS ACROVYN® WALL PANEL

## DEMOUNTABLE FRENCH CLEAT WRAPPED SQUARE EDGE FINISH DETAILS



Hughesville, PA | 800.233.8493 | 570.546.5941  
 Mississauga, ON | 888.895.8955 | 905.274.3611  
[www.c-sgroup.com](http://www.c-sgroup.com)

© Copyright 2019 Construction Specialties, Inc.

PROJECT:	REVISION:
JOB NO.:	F&F:
CUSTOMER:	
REP:	DATE:
DRAWN BY:	SHEET NO:

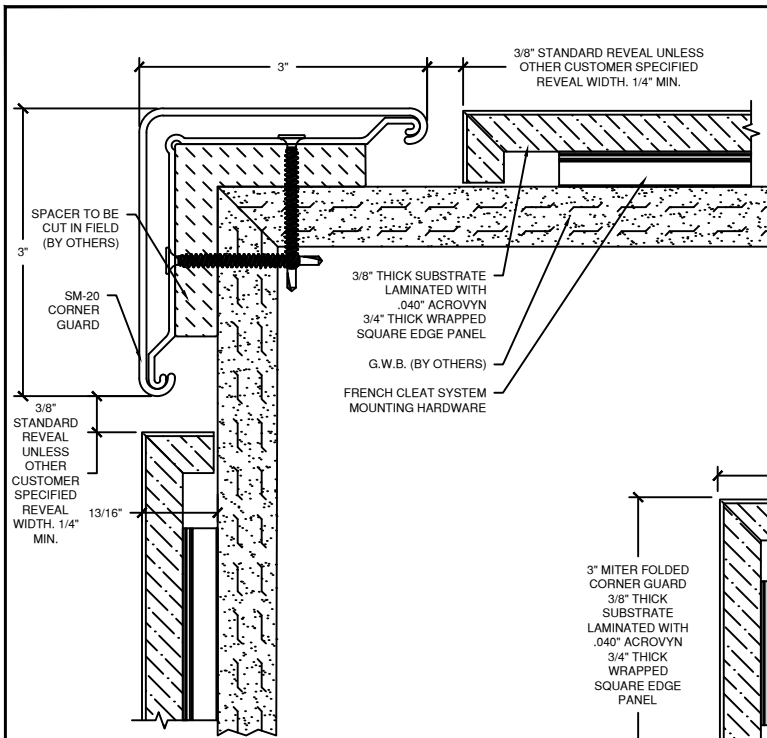

**(D) SM-20 OUTSIDE CORNER OPTION**

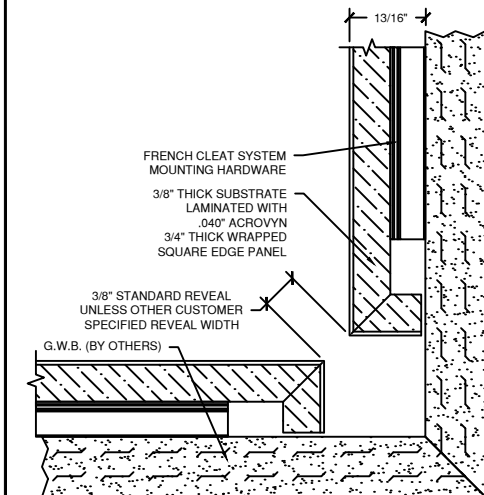

**(F) INSIDE CORNER WITH REVEAL OPTION**

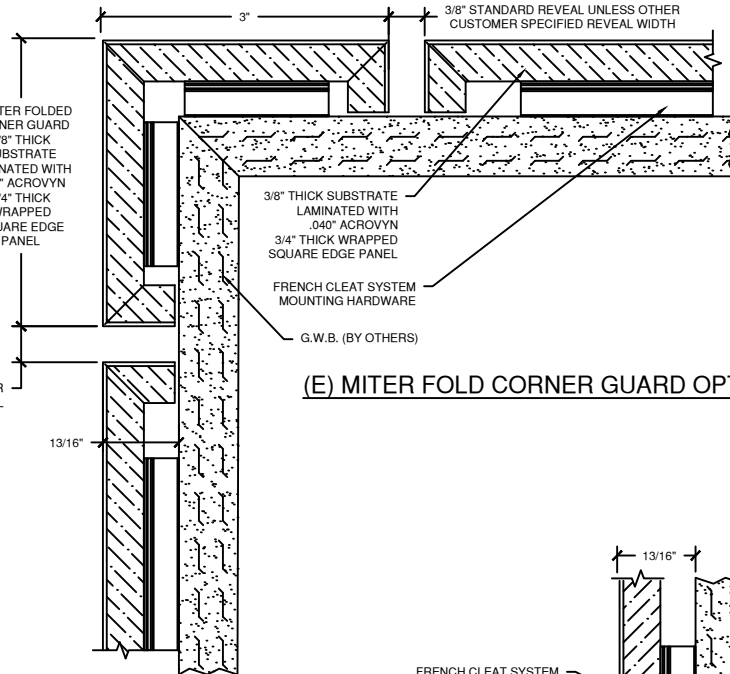

**(E) MITER FOLD CORNER GUARD OPTION**

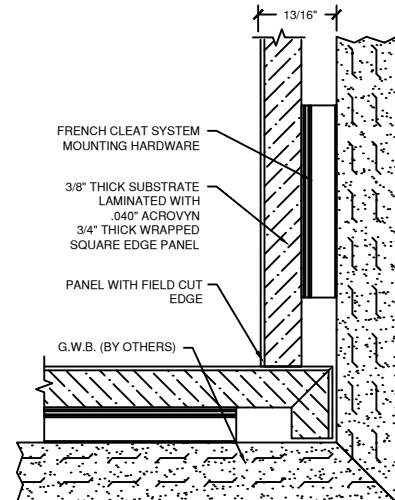

**(G) BUTTED INSIDE CORNER OPTION**

WALL PANEL FABRICATION SCHEDULE CORNER OPTIONS

QTY	OUTSIDE CORNER OPTION (D/E)	MITER FOLD OUTSIDE CORNER SIZE <sup>2</sup>	INSIDE CORNER OPTION (F/G)	REVEAL WIDTH (IF APPLICABLE)

**NOTES:**

1. PLEASE SELECT WHICH INSIDE AND/OR OUTSIDE CORNER CONDITION IS WANTED.
2. MITER FOLD OUTSIDE CORNER SIZE IS TO INCLUDE LEG WIDTHS AND OVERALL HEIGHT.
3. MITER FOLD CORNER GUARDS HAVE A MAXIMUM HEIGHT OF 118".

**CS ACROVYN® WALL PANEL**

DEMOUNTABLE FRENCH CLEAT WRAPPED SQUARE EDGE FINISH DETAILS

 <p>Hughesville, PA   800.233.8493   570.546.5941 Mississauga, ON   888.895.8955   905.274.3611 <a href="http://www.c-sgroup.com">www.c-sgroup.com</a></p> <p>© Copyright 2019 Construction Specialties, Inc.</p>	<b>PROJECT:</b>	<b>REVISION:</b>
	<b>JOB NO.:</b>	<b>F&amp;F:</b>
	<b>CUSTOMER:</b>	
	<b>REP:</b>	<b>DATE:</b>
	<b>DRAWN BY:</b>	<b>SHEET NO:</b>

WALL PANEL FABRICATION SCHEDULE

PANEL COLOR	PANEL SIZE (V X H)	REVEAL TYPE (A-C)	REVEAL WIDTH (IF APPLICABLE)	REVEAL COLOR <sup>1</sup>

NOTES:

1. SHEET REVEAL COLOR IS TO BE ONE OF CS STANDARD ACROVYN COLORS. PAINTED WALL REVEALS ARE TO BE DONE BY OTHERS.

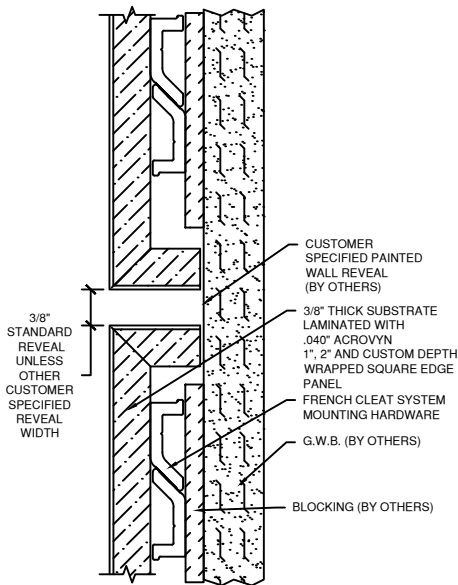

(A) PAINTED WALL REVEAL CONDITION

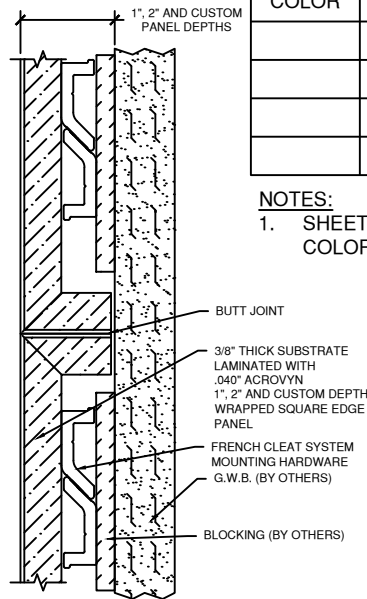

(B) BUTTED PANEL CONDITION

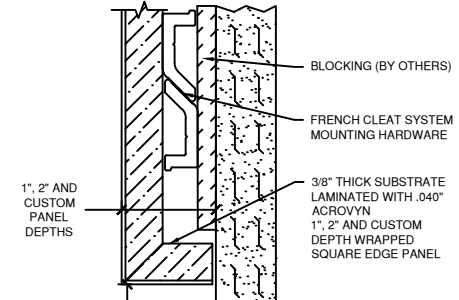
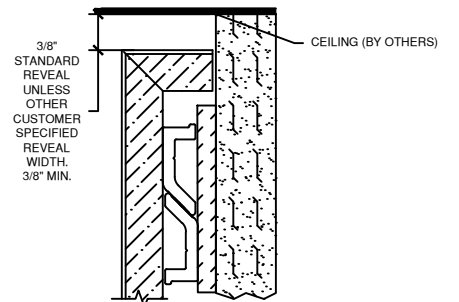

WAINSCOT CONDITION

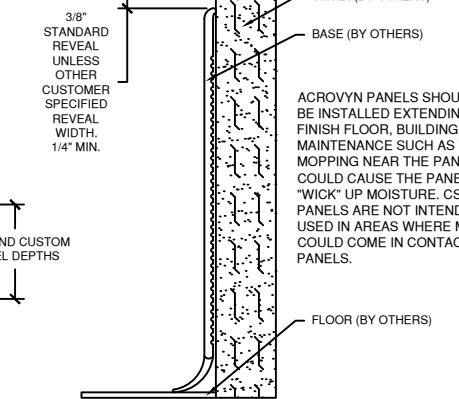

BASE AND CEILING CONDITION

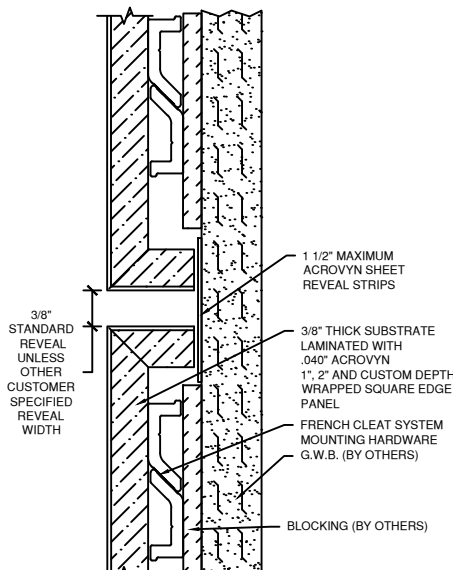

(C) ACROVYN SHEET REVEAL STRIP CONDITION

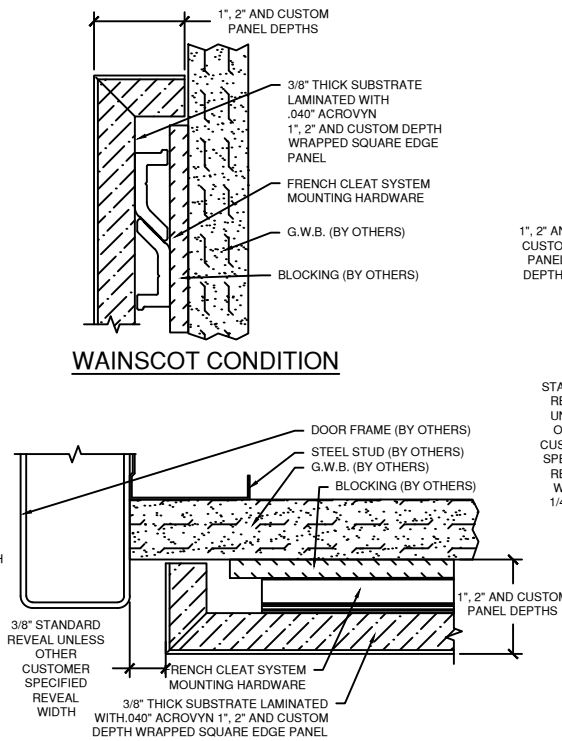

END WALL CONDITION

# CS ACROVYN® WALL PANEL

DEMOUNTABLE FRENCH CLEAT CUSTOM DEPTH WRAPPED SQUARE EDGE FINISH DETAILS

PAGE 3 OF 4

<b>PROJECT:</b>	<b>REVISION:</b>
<b>JOB NO.:</b>	<b>F&amp;F:</b>
<b>CUSTOMER:</b>	
<b>REP:</b>	<b>DATE:</b>
<b>DRAWN BY:</b>	<b>SHEET NO:</b>



Hughesville, PA | 800.233.8493 | 570.546.5941  
 Mississauga, ON | 888.895.8955 | 905.274.3611  
[www.c-sgroup.com](http://www.c-sgroup.com)

© Copyright 2019 Construction Specialties, Inc.

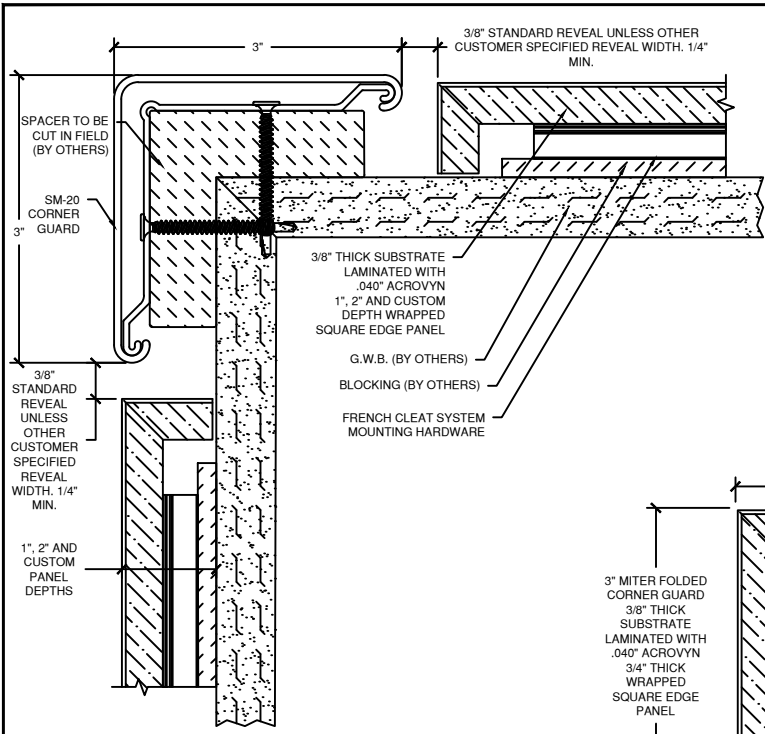

**(D) SM-20 OUTSIDE CORNER OPTION**

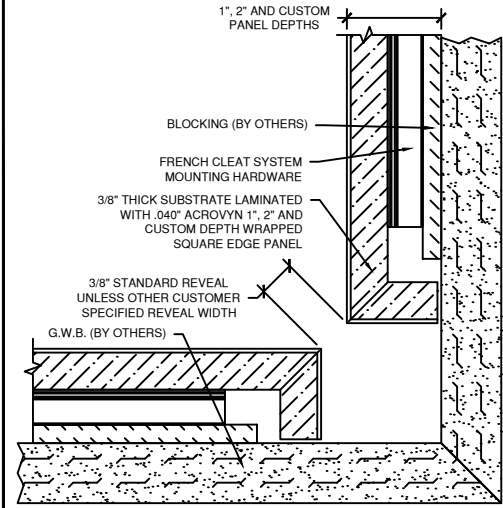

**(F) INSIDE CORNER WITH REVEAL OPTION**

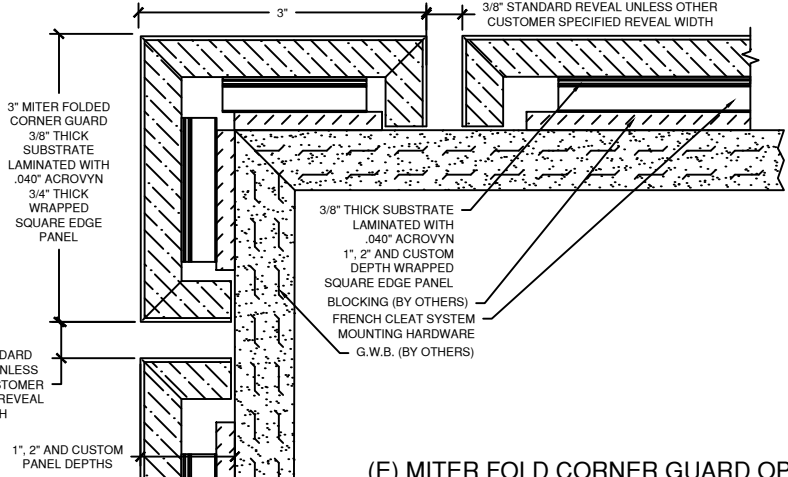

**(E) MITER FOLD CORNER GUARD OPTION**

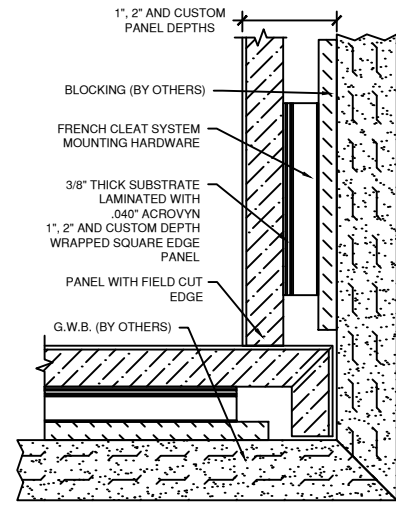

**(G) BUTTED INSIDE CORNER OPTION**

WALL PANEL FABRICATION SCHEDULE CORNER OPTIONS				
QTY	OUTSIDE CORNER OPTION (D/E)	MITER FOLD OUTSIDE CORNER SIZE <sup>2</sup>	INSIDE CORNER OPTION (F/G)	REVEAL WIDTH (IF APPLICABLE)

- NOTES:**
- PLEASE SELECT WHICH INSIDE AND/OR OUTSIDE CORNER CONDITION IS WANTED.
  - MITER FOLD OUTSIDE CORNER SIZE IS TO INCLUDE LEG WIDTHS AND OVERALL HEIGHT.
  - MITER FOLD CORNER GUARDS HAVE A MAXIMUM HEIGHT OF 118".

# CS ACROVYN® WALL PANEL

DEMOUNTABLE FRENCH CLEAT CUSTOM DEPTH WRAPPED SQUARE EDGE FINISH DETAILS

 <p>Hughesville, PA   800.233.8493   570.546.5941          Mississauga, ON   888.895.8955   905.274.3611  <a href="http://www.c-sgroup.com">www.c-sgroup.com</a></p> <p>© Copyright 2019 Construction Specialties, Inc.</p>	<b>PROJECT:</b>	<b>REVISION:</b>
	<b>JOB NO.:</b>	<b>F&amp;F:</b>
	<b>CUSTOMER:</b>	
	<b>REP:</b>	<b>DATE:</b>
	<b>DRAWN BY:</b>	<b>SHEET NO:</b>